

Document Operator's Manual for Basic Function

e-STUDIO3511
e-STUDIO4511





EPA ENERGY STAR® (MFD)

The United States Environmental Protection Agency (EPA) has introduced a voluntary programme, the ENERGY STAR programme, to encourage the widespread and voluntary use of energy-efficient technologies that enhance the workplace, improve product performance and prevent pollution. As an ENERGY STAR Partner, the TOSHIBA TEC CORPORATION has determined that this copier model meets the ENERGY STAR guidelines for energy efficiency.

For Copier/Printer + Fax models, ENERGY STAR guidelines require ENERGY STAR multifunction copiers to have a 'Sleep Mode' feature that automatically makes the copier enter the sleep mode after a period of inactivity. The copier must also automatically change to a 'Low Power Mode' (Automatic Energy Save) after a period of time since the last usage.

◇ **e-STUDIO3511/4511 Copier/Printer + Fax model (multifunction model)**

'Sleep Mode'

The copier consumes less than 80 watts (e-STUDIO3511)/90 watts (e-STUDIO4511) in the 'Sleep Mode'.

'Sleep Mode' Default Time-

The default time while in 'Sleep Mode' is 60 minutes (e-STUDIO3511)/60 minutes (e-STUDIO4511).

'Automatic Energy Save'-

The copier consumes less than 184.75 watts (e-STUDIO3511)/223.25 watts (e-STUDIO4511) while in 'Energy Save Mode'.

'Automatic Energy Save' Default Time-

The default time before switching to 'Automatic Energy Save Mode' is 15 minutes.

Note 1- The default setting for 'Sleep Mode' and 'Automatic Energy save' can be changed.

Note 2- In the sleep mode, if printer data is received, or the start button on the control panel is pressed, the copier starts warming itself up and prints out the data when it becomes ready.

In accordance with EPA ENERGY STAR programme guidelines, Toshiba recommends the following recycled paper.

Great White MultiUse 20 paper

Great White MultiUse 24 paper

If you have any questions regarding the use of recycled paper or some recommended types of recycled paper, please contact your authorized Toshiba dealer.

ENERGY STAR is a U.S. registered mark.

TABLE OF CONTENTS

NOTICE TO USERS.....	5
TOSHIBA QUALITY IS SECOND TO NONE	6
PREFACE.....	8
FEATURES OF THE e-STUDIO3511/4511	9
GENERAL PRECAUTIONS.....	10
When Installing or Moving	10
• When Using the Colour Capable Departmental Systems	13
• During Maintenance or Inspection	15
• When Handling Supplies.....	16
DISCLAIMER NOTICE	17
FORGERY PREVENTION FUNCTION/STORAGE OF COLOUR COPIES	18
1. BEFORE USING EQUIPMENT.....	19
1. DESCRIPTION OF EACH COMPONENT	20
• Main Components.....	20
• Optional Equipment	21
• Control Panel.....	23
• Adjustment of the Angle of the Control Panel.....	25
• Touch Panel.....	27
2. TURNING ON THE POWER SWITCH	30
• Turning on/off the Power.....	30
• Controlling the Use of the Copier with Department Codes	32
• Controlling the Use of the Copier Using the Optional Key Copy Counter.....	33
3. SWITCHING TO THE ENERGY-SAVING MODE	34
2. HOW TO MAKE COPIES.....	35
1. SETTING COPY PAPER	36
• Acceptable Copy Paper Types and Sizes.....	36
• Toshiba-Recommended Paper/Handling and Storing Paper	37
• Changing the Paper Size of the Drawer/Setting the Drawer for Special Uses	38
2. SETTING ORIGINALS.....	45
• Acceptable Original Types and Sizes/Maximum Number of Sheets that can be Stored	45
• When Placing an Original on the Glass.....	47
• When Using the Reversing Automatic Document Feeder (optional)	49
3. GENERAL COPYING PROCEDURES.....	52
4. AUTO JOB START (JOB PRESET).....	55
5. INTERRUPT COPYING	57
6. STOPPING THE COPY OPERATION	58
7. BYPASS COPYING	59
• Bypass Copying.....	59
3. SETTING OF BASIC COPY MODES	65
1. PAPER SELECTION.....	66
• Automatic Paper Selection (APS).....	66
• Manual Paper Selection.....	68
• Setting the [OTHER SIZE] button	69
• Mixed-sized Originals	70
2. BLACK-AND-WHITE/COLOUR COPY MODE SELECTION.....	71
3. REDUCTION AND ENLARGEMENT COPYING	72
4. SELECTING FINISHING MODES	76
• Finishing Modes and Finishers (Optional)	76

• Sort/Group Copying.....	78
• Rotate Sort Mode.....	79
• Staple Sorting	80
• Magazine Sort & Saddle Stitch Mode (Booklet Mode).....	82
• Hole Punch Mode (Optional)	85
5. DUPLEX COPYING	87
• For Making 1-sided, 2-sided and Book-type Copies.....	87
6. ORIGINAL MODE	93
7. COPY DENSITY ADJUSTMENT	94
4. IMAGE EDITING AND IMAGE ADJUSTMENT	95
1. COLOUR BALANCE (YMCK ADJUSTMENT).....	96
2. RGB ADJUSTMENT	97
3. ONE-TOUCH ADJUSTMENT	98
4. BACKGROUND ADJUSTMENT	99
5. SHARPNESS ADJUSTMENT.....	100
6. TWIN (2-COLOUR) COPYING	101
5. USING THE EDITING FUNCTIONS	105
1. IMAGE SHIFT	106
2. EDGE ERASE.....	109
3. BOOK CENTRE ERASE.....	110
4. DUAL-PAGE	111
5. 2 IN 1/4 IN 1.....	113
6. MAGAZINE SORT (FROM THE EDITING MENU).....	116
7. IMAGE EDITING.....	118
• Trimming/Masking	118
• Mirror Image	120
8. X-Y ZOOM	121
9. COVER COPYING.....	122
10. SHEET INSERTION MODE.....	125
11. TIME & DATE STAMP.....	127
12. PAGE NUMBERING	128
13. DIRECTION OF COPY IMAGES IN "1 TO 2" AND "2 TO 1"	130
14. DIRECTION OF DUPLEX COPY IMAGES IN "2 TO 2"	132
15. CONTINUOUS/SINGLE ORIGINAL FEEDING	133
6. STORING ORIGINALS	135
1. STORE TO e-FILING	136
2. SAVE AS FILE	139
3. ENTERING LETTERS	141
7. SCANNING THE IMAGES	143
1. SCAN SETTING IN THE TOUCH PANEL	144
2. SCAN TO e-FILING	147
3. SCAN TO FILE	151
4. SCAN TO E-MAIL.....	155
8. INTERNET FAX.....	161
1. INTERNET FAX	162
2. SENDING INTERNET FAX.....	164
• Setting the Transmission Conditions	164
• Specifying the Recipients.....	167
• Advanced Function.....	177
3. RECEIVING INTERNET FAX	180

9. JOB STATUS	183
1. JOB STATUS	184
2. PRINT JOB LIST.....	185
3. PROOF PRINT JOB	188
4. PRIVATE PRINT JOB	190
5. WHEN USING THE DEPARTMENT CODES	192
6. CONFIRMING THE STATUS OF FAX/INTERNET FAX JOB	194
7. CONFIRMING THE STATUS OF SCAN	195
8. LOG LIST.....	196
• LOG	196
9. ADDRESS REGISTRATION FROM LOG LISTS.....	199
10. PRINTING SEND/RECEIVE LOG LIST OF FAX	201
11. STATUS	202
12. ERROR CODE.....	204
10. e-FILING.....	211
1. e-FILING FUNCTIONS	212
2. SETTING UP BOX.....	214
3. CHANGING INPUT DATA.....	216
4. DELETING BOX	218
5. PRINTING STORED DOCUMENT	219
11. TEMPLATE	223
1. TEMPLATE	224
2. RECALLING TEMPLATE	225
3. REGISTERING TEMPLATE	228
4. CHANGING INPUT DATA.....	233
5. DELETING TEMPLATE	237
12. WHEN THE GRAPHIC SYMBOLS BLINK ON THE TOUCH PANEL.....	241
1. DESCRIPTION OF THE BLINKING GRAPHIC SYMBOLS.....	242
2. ADD PAPER SYMBOL	244
• Adding Paper to the Drawers.....	244
• Adding Paper to the Large Capacity Feeder (Optional).....	245
3. REPLACE TONER CARTRIDGE SYMBOL.....	246
4. REPLACE TONER BAG SYMBOL	253
5. CLEAR PAPER SYMBOL	254
6. ADDING STAPLES (OPTIONAL).....	268
7. REMOVING JAMMED STAPLES (OPTIONAL).....	274
8. DISPOSING OF THE PUNCHED PAPER BITS (OPTIONAL).....	281
9. CALL SERVICE SYMBOL/PERIODIC MAINTENANCE MESSAGE	282
13. MAINTENANCE.....	283
1. DAILY INSPECTION.....	284
2. SIMPLE TROUBLESHOOTING.....	285
14. SPECIFICATIONS & OPTIONS.....	289
1. e-STUDIO3511/4511 SPECIFICATIONS	290
2. SPECIFICATIONS OF OPTIONS	293
3. PACKING LIST	301
4. COPYING FUNCTION COMBINATION MATRIX	302
• Combination Matrix 1/2.....	302
• Combination Matrix 2/2.....	303
5. IMAGE QUALITY ADJUSTMENT COMBINATION MATRIX	304



NOTICE TO USERS

Warning:

This is a Class A product. In a domestic environment this product may cause radio interference in which case the user may be required to take adequate measures.

- 1 Do not touch the connector terminal when disconnecting the cables of peripheral equipment.
- 2 Before opening any covers or removing any parts from the copier, discharge the static electricity from your body by touching a metal part of the copier. This product is carrying the CE-Mark in accordance with the related European Directives. Responsible for CE-marking is TOSHIBA TEC GERMANY IMAGING SYSTEMS GmbH, Carl-Schurz-Str. 7, 41460 Neuss, Germany.
E-mail: customerservice@toshibatec-tgis.com

Machine Noise Information

Ordinance3. GSGV, January 18, 1991: The maximum sound pressure level is equal to or less than 70dB(A) according to EN27779.

After a suitable place has been selected for the installation of the e-STUDIO, please do not change it. Avoid excessive heat dust vibration and direct sunlight. Also, provide proper ventilation as the copier emits a small amount of ozone.

TOSHIBA QUALITY IS SECOND TO NONE

e-STUDIO3511/4511 Toner Cartridges.

It is recommended that genuine TOSHIBA supplies and parts be used to obtain optimum results.

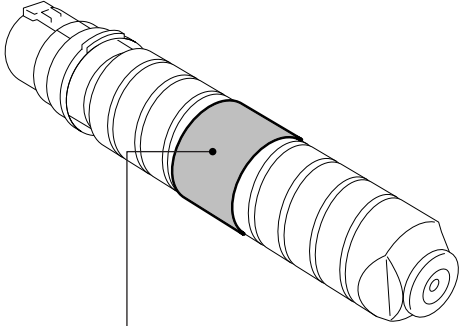
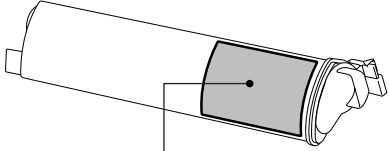
TOSHIBA

T-3511E-K
NET 675 gr

FOR e-STUDIO3511/4511

COMPONENTS: Polyester resin, Carbon black(1333-86-4), Wax, Polypropylene, Silica

TOSHIBA

T-3511E-Y FOR e-STUDIO3511/4511
NET 250 gr

ORIGINAL & GENUINE TOSHIBA TONER

- HANDLE WITH CARE
- STORE IN A DRY PLACE BELOW 35°C(95°F)
- READ THE OPERATING INSTRUCTIONS OF THE MACHINE BEFORE USING
- SHAKE WELL BEFORE USING
- MANIPULER AVEC PRECAUTION
- GARDER DANS UN ENDROIT SANS HUMIDITE OU LA TEMPERATURE AMBIANTE EST MOINS DE 35°C
- LIREZ LE MANUEL D'EMPLOI DE L'APPAREIL AVANT D'EN FAIRE USAGE
- AGITER AVANT EMPLOI

COMPONENTS:
Polyester resin, Organic pigment, Wax, Polypropylene, Silica

TOSHIBA TEC CORPORATION

1-1, Kanda-Nishicho, Chiyoda-ku,
Tokyo 101-8442, Japan
PHONE: 81-3-3434-6654

MADE IN CHINA / FABRIQUE EN CHINE
HERGESTELLT IN CHINA
HECHO EN CHINA / FATTO IN CHINA PAT. P.

TOSHIBA

T-3511E-K
NET 675 gr

FOR e-STUDIO3511/4511

COMPONENTS: Polyester resin, Carbon black(1333-86-4), Wax, Polypropylene, Silica

TOSHIBA

ORIGINAL & GENUINE TOSHIBA TONER

- SHAKE WELL BEFORE USING.
- AGITER AVANT EMPLOI.
- VOR GEBRAUCH GUT SCHÜTTELN.
- AGITARE BENE PRIMA DELL'USO.
- SACUDIR BIEN ANTES DE USAR.
- TAP THE BOTTLE REPEATEDLY.
- TAPER DE FAÇON RÉPÉTÉE SUR LA BOUTEILLE.
- EINIGE MALE WIEDERHOLT AUF DIE TONERFLASCHE KLOPFEN.
- DARE ROPETUTAMENTE DEI COLPETTIALLA BOTTIGLIA.
- GOLPEE SUAVEMENTE LA BASE DEL CARTUCHO DE TONER.

TOSHIBA AMERICA BUSINESS SOLUTIONS, INC.
2 Music, California 92618-1631
(949)462-6000

MADE IN U.S.A. / FABRIQUE AUX ETAS-UNIS
HERGESTELLT IN U.S.A.
HECHO EN U.S.A. / FATTO IN U.S.A. PAT. P.

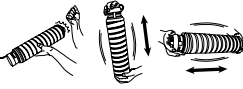

YELLOW
JAUNE
GELB
AMARILLO
GIALLO

BLACK
NOIR
SCHWARZ
NEGRO
NERO

Supplies/Parts

- Dependability

Genuine Toshiba supplies are subjected to the strictest of inspections so that every supply you receive will perform at optimal levels.

- High Productivity

Genuine Toshiba supplies are created to meet the demands of our competitive world and provide high-speed reliable trouble-free copies when you need them.

- Stable Image Quality

Genuine Toshiba supplies are designed to provide consistently stable image output.

- **Copier Kind**

Genuine Toshiba supplies are designed to keep the copier and all its parts in trouble-free working order. Reduction of machine wear is due to Toshiba's intimate knowledge of the copier's characteristics ensuring the highest standard of care.

- Machine Balance

From the beginning Toshiba supplies and machines were made for each other. Whenever Toshiba designs a new machine, it also designs a new toner that is made just for that machine. By using Genuine Toshiba supplies with Toshiba copiers, you are guaranteed optimum performance.

Toner

- Optimum image Quality

Toshiba toner is manufactured using ultra-fine quality materials under precisely controlled conditions to ensure that your Toshiba copiers will continually generate sharp high-quality images.

- Cost Advantage

Genuine Toshiba toner provides value. Only the proper amount of toner is used during the reproduction process thereby enabling the machine to continue to operate until all the toner has been used. In this way you get the full value from each cartridge used.

- Environmental Harmony

Genuine Toshiba toner is manufactured with the environment in mind. To care for Mother Earth, we use embossed or plastic labels making our toner fully recyclable. In addition, harmful dust and ozone levels have been reduced to improve the working environment.

- User Friendly

Genuine Toshiba toner is people-friendly. Before approving our toners for sale, we test them to be sure that they pass the strictest of health standards. This takes the worry out of handling the toner.

General

- **ISO 9000 and ISO 14000**

Toshiba TEC toner plants are ISO 9001 or ISO 9002 and ISO 14001 certified. Our toners are of the highest quality and are environmental friendly.

- Service and Support Benefits

Toshiba's Service engineers are certified to keep your copier performing at optimum levels. To ensure continuous image quality, utilize an authorized Toshiba Service provider to care for and perform periodical maintenance on your copier.

PREFACE

Thank you for purchasing the Toshiba Colour Capable Departmental Systems e-STUDIO3511/4511. This Operator's Manual describes the following:

- How to use the Colour Capable Departmental Systems.
- How to inspect and carry out maintenance on the Colour Capable Departmental Systems.
- How to remedy mechanical and copying problems.

Before using the Colour Capable Departmental Systems, thoroughly read and understand this Operator's Manual. To ensure that clean copies are made at all times and to keep your Colour Capable Departmental Systems in optimum working order, this Operator's Manual should be readily available for future reference.

To ensure correct and safe use of the Toshiba Colour Capable Departmental Systems e-STUDIO3511/4511, this Operator's Manual describes safety precautions according to the following three levels of warning:

Before reading this Operator's Manual, you should fully understand the meaning and importance of these signal words.

- **Warning**

Indicates a potentially hazardous situation which, if not avoided, could result in death, serious injury, or serious damage, or fire in the equipment or surrounding assets.

- **Caution**

Indicates a potentially hazardous situation which, if not avoided, may result in minor or moderate injury, partial damage of the equipment or surrounding assets, or loss of data.

- **Note**

Indicates a procedure you should follow to ensure the optimal performance of the Colour Capable Departmental Systems and problem-free copying.

- **Tip**

Describes handy information that is useful to know when operating the Colour Capable Departmental Systems.

- **Advice**

Describes an operation you should follow to keep the Colour Capable Departmental Systems in good working order.

FEATURES OF THE e-STUDIO3511/4511

The e-STUDIO3511/4511 is a Colour Capable Departmental Systems that is environmentally friendly, compact, and comes at a reasonable price. The e-STUDIO3511/4511 combines black-and-white and colour copy modes and is capable of using each function via networks. The e-STUDIO3511/4511 also has various optional paper handling devices to meet the needs of your office.

The e-STUDIO3511/4511 offers the following convenient features, functions and options.

- The black-and-white copying speed is 35 copies (A4) per minute for e-STUDIO3511, 45 copies (A4) per minute for the e-STUDIO4511. The colour copying speed is 11 copies for both.
- Warm-up time has been drastically shortened to approximately 40 seconds.
- An all-in-one controller, as standard equipment, is installed to perform the effective network functions.
- The input/output interface is designed for internet connection (access) environment.
- A 1/2 VGA wide panel improves operability and efficiency.
- A universal design is adopted for the control panel whose angle can be changed.
- The e-Filing function allows you to scan, save, reuse, and re-edit the original data via client PCs from the scanning section.
- Received Fax documents can be stored in the e-Filing without printing them.
- Scanned originals can be sent via Fax (optional) and E-mail simultaneously.
- Electric sorting improves both colour and black-and-white copying productivity.
- Comes with rich editing functions such as trimming, masking and mirror.
- Loading the page memory and hard disc as standard equipment enables 2 in 1/4 in 1, Electronic sorting and magazine sorting, etc.
- A fixing system that uses less oil reduces the amount of oil affixed to the paper.
- By simply replacing the cartridge, you can add toner without dirtying your hands.
- A wide variety of media from thick paper (up to 209 g/m²), sticker labels, OHP films, etc. is acceptable. The image quality technology offers up to 999 successive stable copy images.
- Installing an optional finisher offers quick automatic sorting, stapling and hole punching (optional) of copies.
- Installing a finisher with an optional saddle stitching function attached allows you to select the saddle stitching mode which will automatically staple the centre of the documents just like a book.
- Two energy-saving features are available: 1. ENERGY SAVER MODE: Unnecessary electricity at READY status is cut off, 2. SLEEP MODE: The minimum power consumption is kept if the equipment is not used for the specified period.

GENERAL PRECAUTIONS

When Installing or Moving

Warning

- This Colour Capable Departmental Systems requires 220-240 V AC 50/60 Hz electric power. For Saudi Arabia 100V version, it requires 100-127 V AC 50/60 Hz electric power.
DO NOT use a power supply with a voltage other than that specified.
Avoid multiple connections in the same outlet. This could cause a fire or give you an electric shock. If you are considering increasing the number of outlets, contact an electrician.
- ALWAYS connect this Colour Capable Departmental Systems to an outlet with a ground connection to avoid the danger of fire or electric shock in case of short-circuiting. Contact your service representative for the details. Be sure to use a 3-conductor, grounded wall outlet.
In areas where a 2-pin plug is used, the Colour Capable Departmental Systems must be grounded for safety. Never ground it to a gas pipe, a water pipe, or any other object not suitable for grounding.
- Plug the power cord securely into the outlet. If it is not plugged in properly, it could heat up and cause a fire or give you an electric shock.
- DO NOT damage, break or attempt to repair the power cord.
The following things should not be done to the power cord.
 - Twisting it - Bending it - Pulling it
 - Placing anything on it - Making it hot - Situating it near radiators or other heat sourcesThis could cause a fire or give you an electric shock. If the power cord is damaged, contact your service representative.
- When removing the plug from the outlet, DO NOT PULL the power cord. ALWAYS hold the plug when removing it from the outlet. If the power cord is pulled, the wires may become broken and this could cause a fire or give you an electric shock.
- Make sure that the ventilation holes are not blocked up.
If the temperature within the Colour Capable Departmental Systems becomes too high, a fire could result.
- DO NOT move the Colour Capable Departmental Systems to another building, up and down the stairs or for any great distance.
This could cause an injury or give you an electric shock. When lifting or moving the Colour Capable Departmental Systems, contact your service representative.
- DO NOT move the Colour Capable Departmental Systems with optional equipment, such as the finisher, attached. This could cause a fire or give you an electric shock. When lifting or moving the Colour Capable Departmental Systems, contact your service representative.
- When moving the Colour Capable Departmental Systems, be sure to shut down the power prior to pulling out the plug from the outlet. If the power cord is damaged, this could cause a fire or give you an electric shock.
- The socket outlet should be near the equipment and be easily accessible.
- Pull out the plug from the outlet more than once a year to clean around the prongs. Accumulating dust and dirt could cause a fire due to the heat released by electric leakage.

Caution

- DO NOT tilt the Colour Capable Departmental Systems more than 10 degrees when moving it. If it falls, this could result in personal injury.
- Avoid placing the Colour Capable Departmental Systems in a place unsuitable for its weight and also make sure the surface is level.

Remember that if the Colour Capable Departmental Systems falls over, serious injuries could result. Weight of the Colour Capable Departmental Systems: approx. 112 kg

- There are 4 adjusters (stoppers) on both sides (2 adjusters each) and 2 safety stoppers in front at the bottom of the paper feed pedestal and the large capacity feeder. After moving and installing the equipment, be sure to turn the adjusters clockwise to fix them firmly on the floor as shown in the illustration. Then fix the safety stoppers in the same way.

If they are not adjusted correctly and the equipment falls, this could result in personal injury. To move the equipment, turn the safety stoppers and the adjusters anticlockwise.

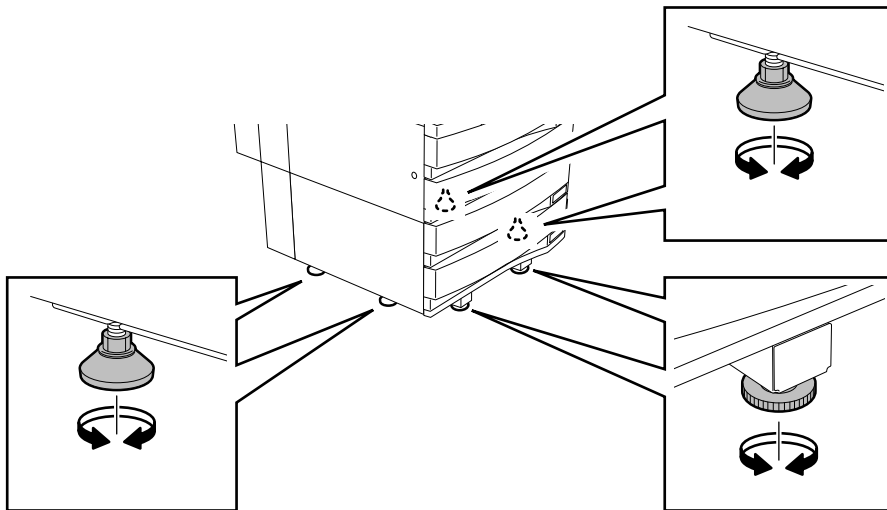

- When connecting the optional equipment and interface cable to the Colour Capable Departmental Systems, be sure to turn the main OFF. If the main switch is not turned off, you could get an electric shock.

Other Points

- Make sure that there is enough space around the system to facilitate changing of parts and maintenance. If there is insufficient space, some operations, such as bypass feeding, will become difficult and the Colour Capable Departmental Systems could even break down. To insure optimal operation, allow clearances of at least 80 cm on the right, and 10 cm on the left and behind (refer to the illustration below).

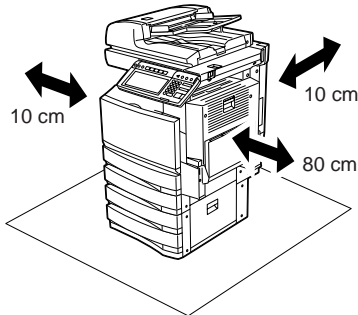

- Adverse environmental conditions may affect the safe operation and performance of the Colour Capable Departmental Systems, and the Colour Capable Departmental Systems could break down.
 - Avoid locations near windows or with exposure to direct sunlight.
 - Avoid locations with drastic temperature fluctuations.
 - Avoid too much dust.
 - Avoid location that suffer from vibration.
- Allow the air to flow freely and make sure there is a ventilator. With inadequate ventilation, the unpleasant odor released by ozone will begin to dominate the atmosphere.

When Using the Colour Capable Departmental Systems

Warning

- DO NOT place metallic objects or containers with water (flower vases, coffee cups, etc.) on or near the Colour Capable Departmental Systems. And keep paper clips and staples away from the air vent. This could cause a fire or give you an electric shock.
- If the Colour Capable Departmental Systems becomes excessively hot, smoke comes out of it or there is an odd smell or noise, proceed as follows.
Turn the main switch OFF and remove the plug from the outlet, then contact your service representative.
- If the Colour Capable Departmental Systems will not be used for more than one month, remove the plug from the outlet for safety purposes during that time.
This could cause a fire or give you an electric shock if an insulation failure occurs.

Caution

- DO NOT place heavy objects (4 kg or more) on the original glass and do not press on it with force.
Breaking the glass could cause personal injury.
- DO NOT place heavy objects (4 kg or more) on the Colour Capable Departmental Systems. If the objects fall off, this could cause injury.
- DO NOT remove or connect the plug with wet hands, as this could give you an electric shock.
- DO NOT touch the fuser unit and the metal area around it. Since they are very hot, you could be burned or the shock could cause you to get your hand injured in the machine.
- When changing the angle of the control panel, be careful not to let your hands be caught in the gap between the equipment and the control panel. This could injure you.

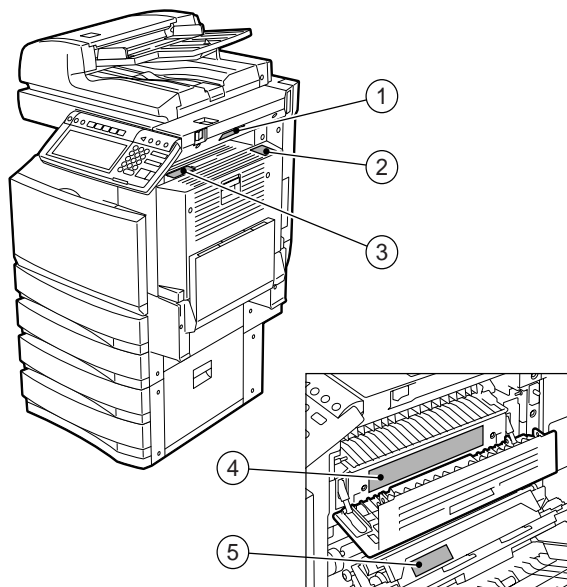

- 1: Warning for high temperature areas (Ventilation holes)
- 2: Warning for high temperature areas (Fuser unit) - The labels are attached on 3 places.
- 3: Warning for handling Transfer belt
- DO NOT touch the metal portion of the guide board in the automatic duplexer as it could burn you.

Other Points

- Be very careful to treat the touch panel gently and never hit it. Breaking the surface could cause malfunctions.
- DO NOT turn the main switch OFF with jammed paper left inside the Colour Capable Departmental Systems.
This could cause malfunctions when the main switch is turned ON next time.
- Be sure to turn the main switch OFF when leaving the office or if there is a power outage. However, DO NOT turn the main switch OFF if the weekly timer is in use.

During Maintenance or Inspection

Warning

- NEVER attempt to repair, disassemble or modify the Colour Capable Departmental Systems by yourself. You could cause a fire or get an electric shock.
ALWAYS contact your Service representative for maintenance or repair of the internal parts of the Colour Capable Departmental Systems.
- ALWAYS keep the plug and outlet clean. Prevent them from accumulating dust and dirt. This could cause a fire and give you an electric shock due to the heat released by electric leakage.
- DO NOT let liquids such as water and oil get into the system when cleaning the floor. This could cause a fire and give you an electric shock.

Caution

- DO NOT touch the stapling area. The actual needle point could cause you personal injury. "Saddle-Stitch Finisher (MJ-1024)"  Page 276

Other Points

- DO NOT use such solvents as thinner or alcohol when cleaning the surface of the Colour Capable Departmental Systems.
 - This could warp the shape of the surface or leave it discoloured.
 - When using a chemical cleaning pad to clean it, pay attention to any cautionary points.

When Handling Supplies

Caution

- NEVER attempt to incinerate toner cartridges. This could cause an explosion. DO NOT dispose of used toner cartridges. Your service technician will collect them. "3.REPLACE TONER CARTRIDGE SYMBOL"

 Page 246

DISCLAIMER NOTICE

The following notice sets out the exclusions and limitations of liability of TOSHIBA TEC CORPORATION (including its employees, agents and sub-contractors) to any purchaser or user ('User') of the e-STUDIO3511/4511, including its accessories, options and bundled software ('Product').

- 1 The exclusion and limitations of liability referred to in this notice shall be effective to the fullest extent permissible at law. For the avoidance of doubt, nothing in this notice shall be taken to exclude or limit TOSHIBA TEC CORPORATION's liability for death or personal injury caused by TOSHIBA TEC CORPORATION's negligence or TOSHIBA TEC CORPORATION's fraudulent misrepresentation.
- 2 All warranties, conditions and other terms implied by law are, to the fullest extent permitted by law, excluded and no such implied warranties are given or apply in relation to the Products.
- 3 TOSHIBA TEC CORPORATION shall not be liable for any loss, cost, expense, claim or damage whatsoever caused by any of the following:
 - (a) use or handling of the Product otherwise than in accordance with the manuals, including but not limited to Operator's Manual, User's Guide, and/or incorrect or careless handling or use of the Product;
 - (b) any cause which prevents the Product from operating or functioning correctly which arises from or is attributable to either acts, omissions, events or accidents beyond the reasonable control of TOSHIBA TEC CORPORATION including without limitation acts of God, war, riot, civil commotion, malicious or deliberate damage, fire, flood, or storm, natural calamity, earthquakes, abnormal voltage or other disasters;
 - (c) additions, modifications, disassembly, transportation, or repairs by any person other than service technicians authorized by TOSHIBA TEC CORPORATION; or
 - (d) use of paper, supplies or parts other than those recommended by TOSHIBA TEC CORPORATION.
- 4 Subject to paragraph 1, TOSHIBA TEC CORPORATION shall not be liable to Customer for:
 - (a) loss of profits; loss of sales or turnover; loss of or damage to reputation; loss of production; loss of anticipated savings; loss of goodwill or business opportunities; loss of customers; loss of, or loss of use of, any software or data; loss under or in relation to any contract; or
 - (b) any special, incidental, consequential or indirect loss or damage, costs, expenses, financial loss or claims for consequential compensation;

whatsoever and howsoever caused which arise out of or in connection with the Product or the use or handling of the Product even if TOSHIBA TEC CORPORATION is advised of the possibility of such damages.

TOSHIBA TEC CORPORATION shall not be liable for any loss, cost, expense, claim or damage caused by any inability to use (including, but not limited to failure, malfunction, hang-up, virus infection or other problems) which arises from use of the Product with hardware, goods or software which TOSHIBA TEC CORPORATION has not directly or indirectly supplied

FORGERY PREVENTION FUNCTION

This copier has a forgery prevention function.

Please ensure that your digital full-colour copier is not used for making copies of prohibited items.

STORAGE OF COLOUR COPIES

- 1 The copies should be kept in a place which is not exposed to light to prevent fading when they are stored for a long time.
- 2 If copies are kept pressed between plastics made of chloroethylene for a long time, the toner may melt and stick to the plastic due to high pressure and high temperature. Keep them in polyethylene binders.
- 3 When a colour copy is folded, the toner at the fold can become separated.
- 4 The toner on the copies may melt if it touches solvent. If the ink on the copies has not completely dried, the toner may also melt. Keep copies away from solvent.
- 5 When copies are kept near an extremely high temperature such as a heater, the toner may melt. Keep them at room temperature and do not allow this to vary very much.

1. BEFORE USING EQUIPMENT

1. DESCRIPTION OF EACH COMPONENT	20
Main Components	20
Optional Equipment	21
Control Panel	23
Adjustment of the Angle of the Control Panel	25
Touch Panel	27
2. TURNING ON THE POWER SWITCH	30
Turning on/off the Power	30
Controlling the Use of the Copier with Department Codes	32
Controlling the Use of the Copier Using the Optional Key Copy Counter	33
3. SWITCHING TO THE ENERGY-SAVING MODE	34

1. DESCRIPTION OF EACH COMPONENT

Main Components

1

- 1: Front cover
- 2: Drawers
- 3: Operator's manual pocket (back side)
- 4: Power switch
- 5: Automatic duplexer
- 6: Bypass tray
- 7: Original scale
- 8: Inner tray
- 9: Colour of toner (Cyan/Magenta/Yellow)
- 10: Control panel
- 11: Touch panel
- 12: Touch panel contrast adjustment volume
- 13: Black toner
- 14: Used toner bag
- *1, *2: Optional

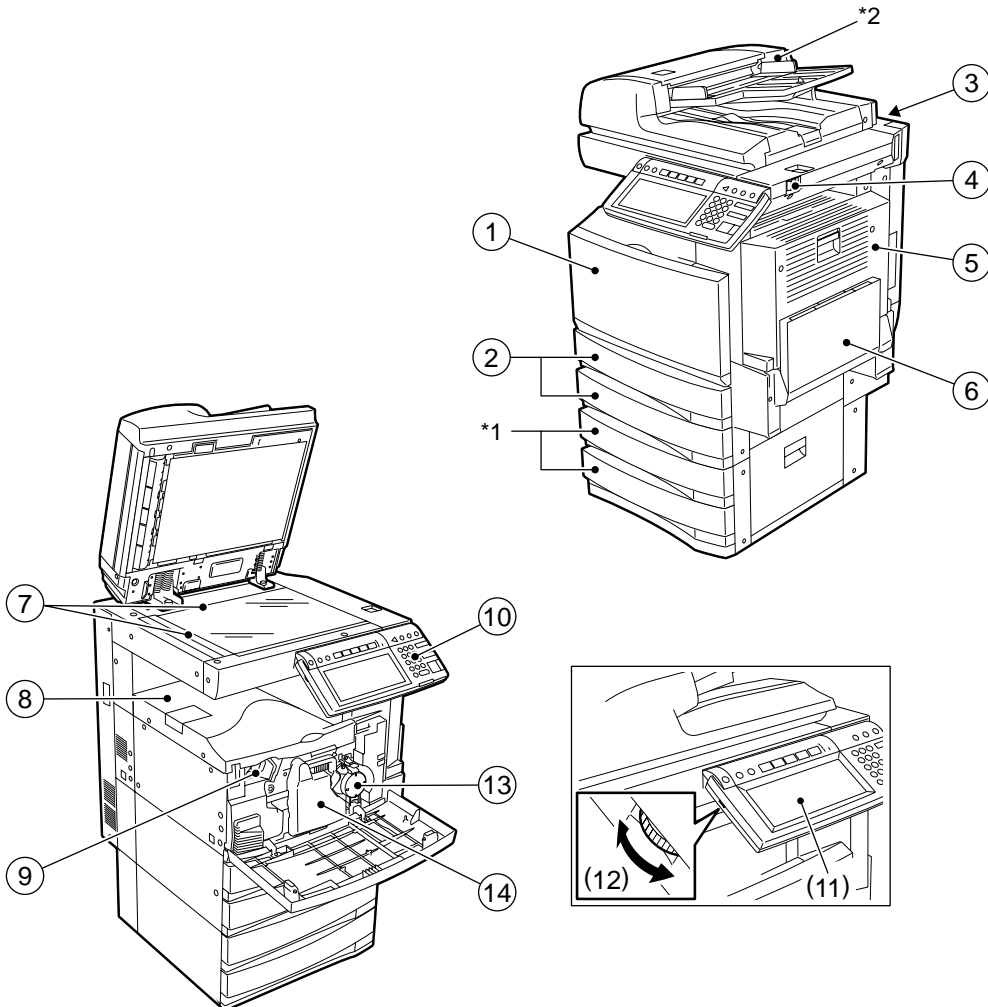

Optional Equipment

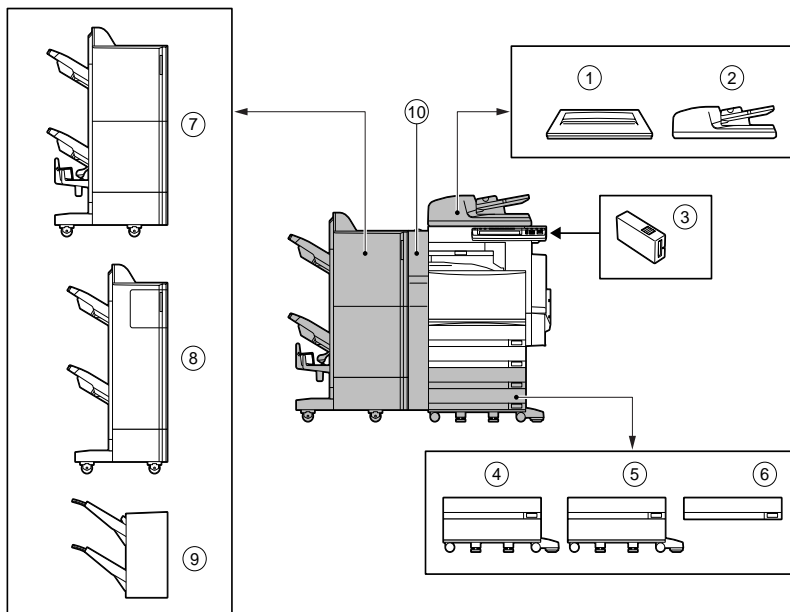

1 : Original cover (KA-3511)

Holds an original.

2 : Reversing automatic document feeder (MR-3015)

Automatically feeds a placed stack of originals one by one to have them copied.

3 : Key copy counter (MU-8, MU-10)

Records or accumulates the number of output pages separately for each person or group.

4 : Large capacity feeder (KD-1012)

Feeds up to 2,500 sheets of A4 paper (80 g/m²) (recommended by Toshiba) continuously.

5 : Paper feed pedestal (KD-1011)

Adds one drawer to the equipment.

6 : Additional drawer module (MY-1021)

Enables one drawer to be added to the paper feed pedestal.

7 : Saddle-stitch finisher (MJ-1024)

Enables the saddle stitching in addition to the sort/group mode and stapling. (Hole punch unit can be installed.) Requires the relay unit (sold separately) for the installation.

8 : Multi-staple finisher (MJ-1023)

Enables the sort/group mode and stapling. (Hole punch unit can be installed.) Requires the relay unit (sold separately) for the installation.

9 : Single-staple finisher (MJ-1022) (for e-STUDIO3511 only)

Enables the sort/group mode and stapling. Requires the relay unit (sold separately) for the installation.

10: **Hole punch unit (MJ-6004)**

Makes punching holes on output pages.

We have other options: Work table (KK-3511), Fax board (GD-1150), Fax board 2nd line (GD-1160), Expansion memory (GC-1180), Wireless LAN adapter (GN-1010), Scrambler board (GP-1030)
Contact your service technician or representative for the details.

Control Panel

When operating the equipment and specifying the various settings through the equipment itself, use the buttons on the control panel.

1

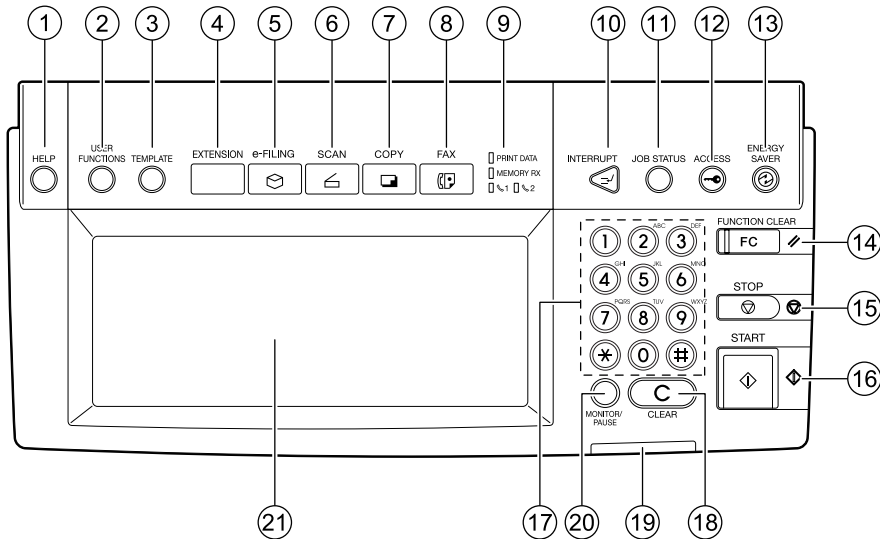

1 : [HELP] button

When pressing this button, appropriate operation procedures are displayed.

2 : [USER FUNCTIONS] button

Press this button to set the paper size of the drawer, the drawer for special use, or to set/register the settings including such as the change of the default setting of the copy, scan and Fax functions. See the [User Function Guide].

3 : [TEMPLATE] button

Use this button to store and recall the various settings that are frequently used for copy, scan and Fax functions.

4 [EXTENSION] button

This is the button to extend functions in the future. It is invalid at present.

5 : [e-FILING] button

Use this button to access the saved image data.

6 : [SCAN] button

Press this button to use the scanning function.

7 : [COPY] button

Press this button to use the copy function.

8 : [FAX] button

Press this button to use the Fax/Internet Fax function.

9 : PRINT DATA/MEMORY RX/FAX communication

If these lamps light, they show the status of receiving data, receiving original(s) standing by to be printed and currently used telephone line (1 or 2).

10: [INTERRUPT] button

Use this button to interrupt the copying job in process and to perform another copying job. You can resume the interrupted copying job by pressing this button again.

11: [JOB STATUS] button

Use this button to confirm each status of print or scan or Fax, and journal for TX or RX of Fax.

12: [ACCESS] button

Use this button when the department codes have been set.

If this button is pressed after copying, the next user cannot use the copy function without keying in the registered department code. (See the [User Function Guide].)

13: [ENERGY SAVER] button

If you are not going to use the equipment for a while, press this button. The equipment enters the energy saving mode and all the display lamps are turned off.

14: [FUNCTION CLEAR] button

When this button is pressed, all selected functions are cleared and returned to the default settings.

"3.GENERAL COPYING PROCEDURES"  Page 52

*Automatic Function Clear

Even if you do not press the [FUNCTION CLEAR] button, within the specified period of time after copying is finished or after the last button is pressed in a copy procedure, the automatic function clear mode will clear all settings to defaults, and the basic screen will be displayed. While the department management function is being operated, the display returns to the access code input screen.

15: [STOP] button

Use this button to stop an ongoing scan and copy operation.

16: [START] button

Press this button to start copying, scanning and Fax operation.

17: Digital keys

Use these keys to enter the number of copies you want to make and so on.

18: [CLEAR] button

Use this button to correct numbers entered with the digital keys such as an incorrect copy quantity.

19: ERROR lamp

ERROR lamp lights in red when an error occurs and the equipment needs some actions.

20: [MONITOR/PAUSE] button

This button is used when the copier is used as a Fax (optional). (See the [Operator's Manual for Facsimile Function] for detail.)

21: Touch Panel

The state of a copier and directions for its operation are expressed as characters and illustrations.

Adjustment of the Angle of the Control Panel

When Adjusting the Angle of the Control Panel

1

The angle of the control panel is adjustable at any angle from 5 to 45 degrees from the horizontal position (at the time of installation).

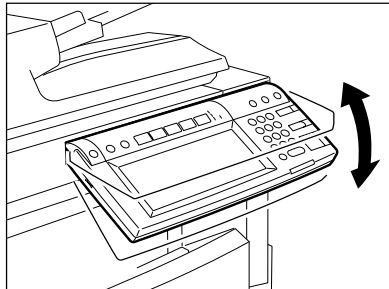

* When changing the angle of the control panel, be careful not to let your hands be caught in the gap between the equipment and the control panel. This could injure you.

When Fixing the Angle of the Control Panel

When you want to fix the angle of the control panel (at 7 degrees from the horizontal position), move the stopper attached on the backside of the control panel from the position (1) to (2).

Perform the following procedure to move the stopper.

- 1: The position where the angle is adjustable.
- 2: The position where the angle is fixed.

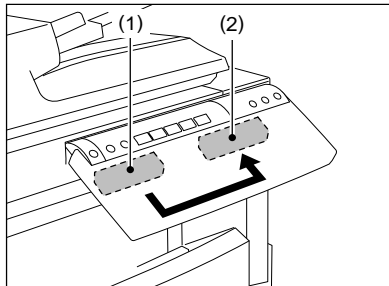

1

1 Slightly shift the stopper to the right, and then pull it out.

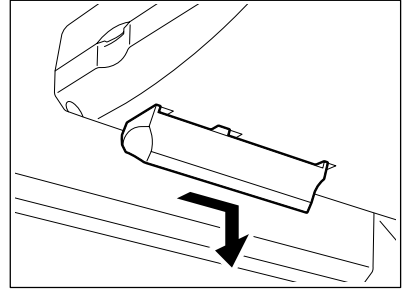

2 Fit the latches of the stopper in the hole of the position (2) and insert them turning the stopper itself.

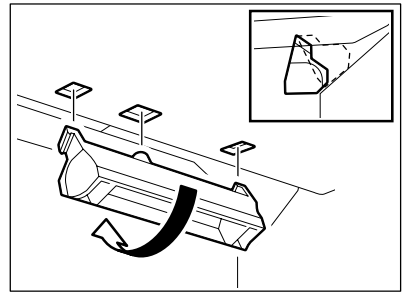

3 Shift the stopper to the left until it clicks.

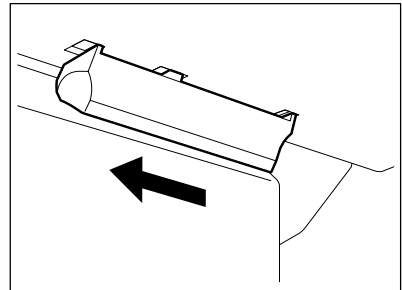

- The angle of the control panel is fixed at 7 degrees.

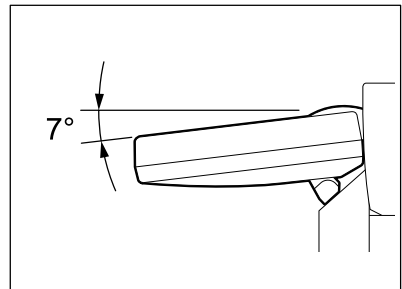

Touch Panel

When the power is turned on, and 'READY' is displayed, the basic screen of the copy function is shown on the touch panel.

On the screen, currently set functions, selected functions and the copier status are shown via messages and illustrations.

* The contents of the touch panel screens in this manual show the equipment with all options.

- | | |
|-----------------------------------|--------------------------------------|
| 1: Message | 6: Date and time |
| 2: Reproduction ratio | 7: Set functions confirmation button |
| 3: Total copy quantity | 8: Function setting area |
| 4: Currently selected drawer size | 9: Index buttons |
| 5: Remaining paper level | |

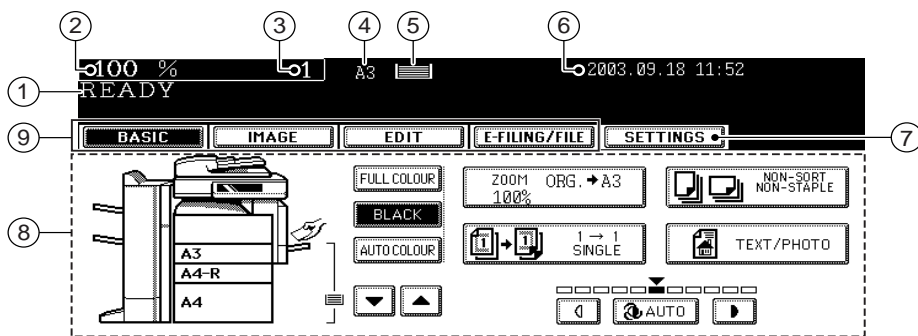

Message Display

The following information is shown on the touch panel:

Equipment status, operational instructions, cautionary messages, reproduction ratios, total copy quantity, paper size of a selected drawer, amount of paper in a selected drawer and the date and time.

Touch-buttons

The various function items are touch-button selectable. Press any buttons lightly with your finger.

- Index buttons

This button is used for switching the menu. The type and the number of the index buttons varies depending on each function of Copy, Scan and Fax.

- Function setting area

This is an area for selecting and setting each function.

- [SETTINGS] (set functions confirmation) button

This button allows you to confirm the functions that have been set.
(An example is shown below.)

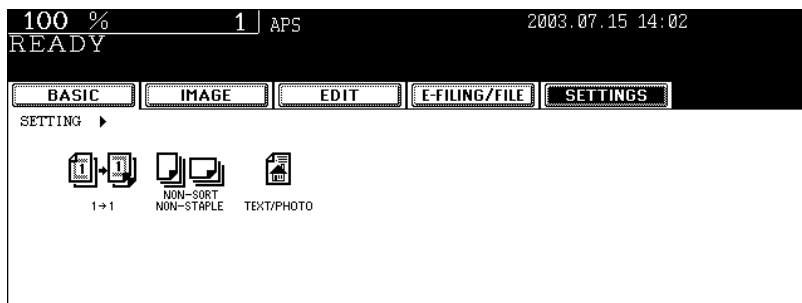

- The icons displayed on the screen are as follows (some icons may not appear on the screen):

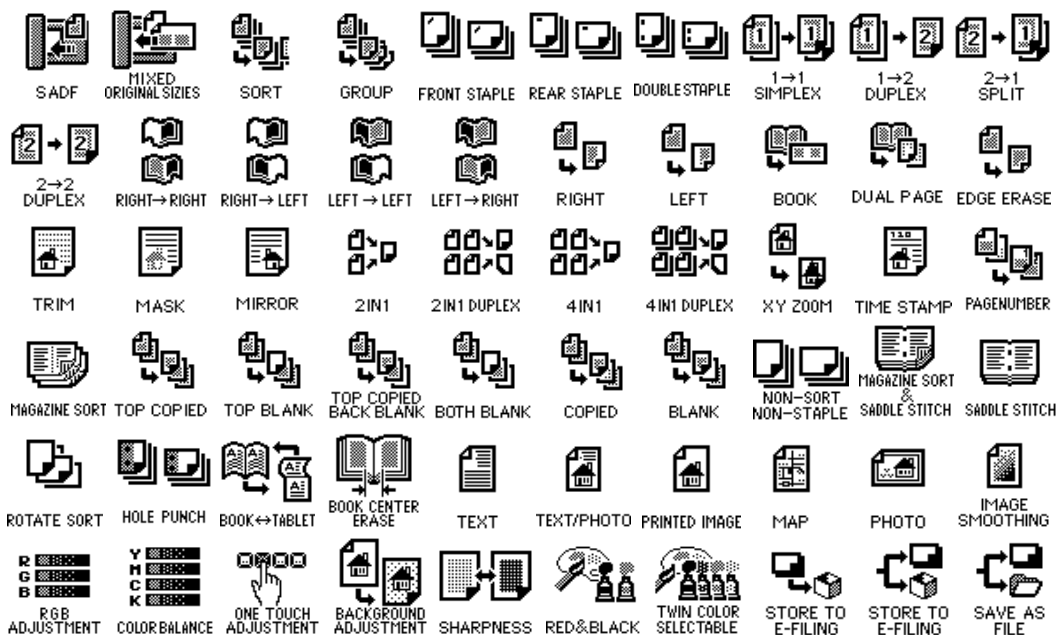

Clearing the Functions Selected

If you press any button that is half-tone shaded, the function selected is cleared. Also, if the copier is left inactive for a while, the automatic function clear works and the setting will be cleared.

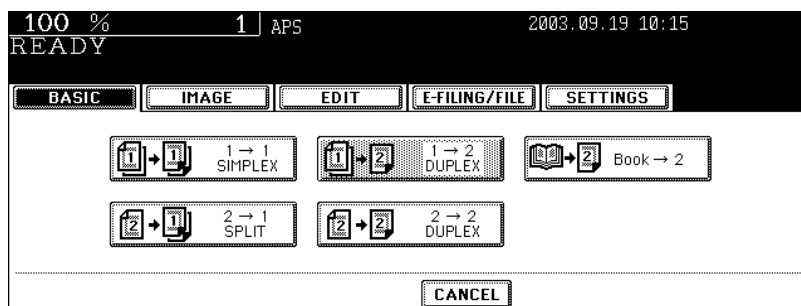

- Automatic Function Clear

Even if you do not press the [FUNCTION CLEAR] button, within the specified period of time (default setting: 45 seconds) after outputting is finished or after the last button is pressed in a procedure, the automatic function clear mode will work to clear all settings, and the basic screen of the copy function will be displayed. While the department management function is being operated, the display returns to the department code input screen.

The period for the automatic function clear is selectable. (See the [User Function Guide].)

2. TURNING ON THE POWER SWITCH

Turning on/off the Power

1

Turning on the Power Switch

1 Open the switch cover, and then turn ON the power switch.

- "Wait Warming Up" appears on the Basic screen on the touch panel.

2 About 40 seconds later, the equipment will be ready.

- "READY" appears on the Basic screen.

Tips

- While the copier is warming up, you can use the Auto Job Start function. "4.AUTO JOB START (JOB PRESET)"  Page 55
- "POWER FAILURE" message:
When restarting the equipment due to the power failure, etc., "POWER FAILURE" appears at the upper right of the screen. To clear it, press the [FUNCTION CLEAR] button twice.
The job in progress at the time of the power failure is deleted.

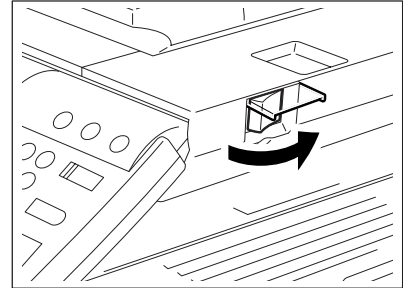

Turning off the Power (Shutting down)

When turning off the power of the equipment, perform the following shutdown procedure.

DO NOT turn off the power by switching off the power switch of the equipment as it can cause the failure of the hard disc.

Before turning off the power, be sure that the following 3 conditions are satisfied.

- No jobs are left in the printing job list. See "1.JOB STATUS"  Page 184.
- The ERROR lamp is not blinking.
- No PCs access the equipment via network.

1 Press the [USER FUNCTION] button on the control panel.

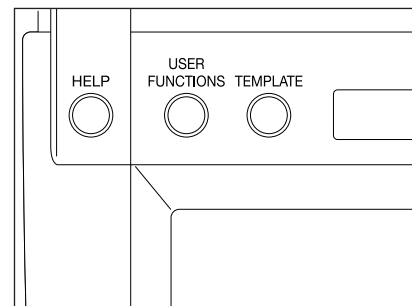

- 2** Press the [USER] button to enter the user setting menu, and then press the [SHUTDOWN] button.

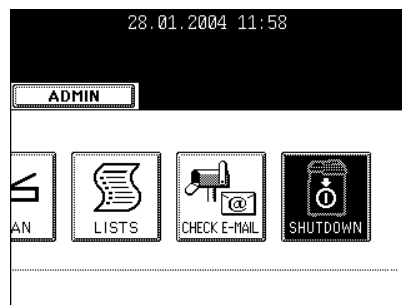

- 3** "Processing job will be deleted. Are you sure you want to shutdown?" appears on the screen. Press the [YES] button.

- To cancel the shutdown operation, press the [NO] button.

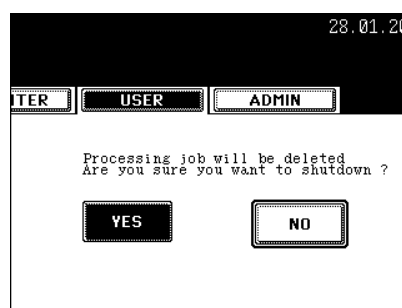

- 4** "Shutdown in progress" appears on the screen, and then the equipment is shut down.

- The power switch automatically returns to the OFF position.



Controlling the Use of the Copier with Department Codes

1

With the use of the department codes, you can restrict users as well as manage copy volumes made by individual groups or departments of your company. See the [User Function Guide].

* The department codes and the key copy counters ("Controlling the Use of the Copier Using the Optional Key Copy Counter"  Page 33) cannot be used together.

1 When the department management function has been set, the screen shown on the right appears after the power switch is turned on.

- The same screen is displayed when the [ACCESS] button is pressed or the automatic function clear mode is activated.

2 Key in a registered department code (5-digit).

- The copier will be ready for copying.

Tip

If "Enter Department Code" remains, the department code you have entered may be incorrect. Press the [RESET] button, and then key in the correct code.

- After Copying is finished.

If the department control function is in use, be sure to press the [ACCESS] button on the control panel after finishing the use of the equipment. The display returns to the department code input screen and the department management function will remain active.

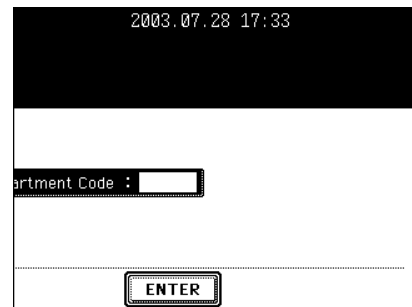
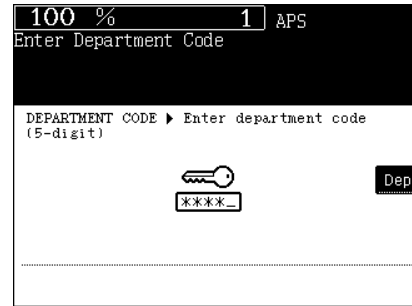

Controlling the Use of the Copier Using the Optional Key Copy Counter

When the optional key copy counter is available, you can only make copies by inserting your key copy counter. When you make copies with your key copy counter inserted, the number of copies made is recorded (or added up) in the counter. Any number of key copy counters can be used.

* For instructions on how to use the key copy counter, consult your service technician.

* Key copy counters and access codes ("Controlling the Use of the Copier with Department Codes" Page 32) cannot be used together.

1

1 "Insert key copy counter" appears on the Basic screen.

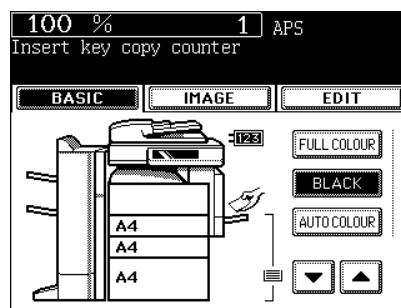

2 Insert your key copy counter slowly in the direction as shown on the right until it comes to a stop.

Note

Do not pull out the key copy counter during copying.

Tip

After Copying is Finished

After you have finished making copies, remove your key copy counter.

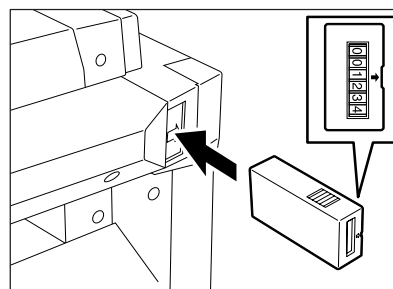

3. SWITCHING TO THE ENERGY-SAVING MODE

1

If you are not going to use the equipment for a while, press the [ENERGY SAVER] button on the control panel for a few seconds to enter the energy saving mode.

In this mode, the display and lighted button on the control panel are turned off and the [ENERGY SAVER] button lights in green. To start the equipment again, press the [ENERGY SAVER] button (or [COPY], [SCAN], [FAX], [e-FILING], [START] button on the control panel).

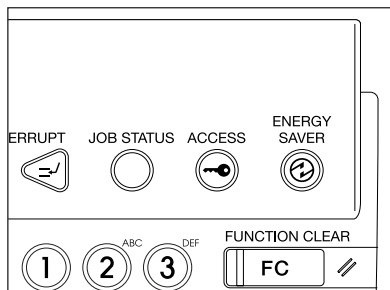

Even if the [ENERGY SAVER] button is pressed, the power supply to the printer board (and optional Fax board when being installed) is not cut off.

When a job for printing (or Fax) is received, the equipment becomes automatically ready status.

2. HOW TO MAKE COPIES

1. SETTING COPY PAPER	36
Acceptable Copy Paper Types and Sizes	36
Toshiba-Recommended Paper/Handling and Storing Paper	37
Changing the Paper Size of the Drawer/Setting the Drawer for Special Uses.....	38
2. SETTING ORIGINALS	45
Acceptable Original Types and Sizes/Maximum Number of Sheets that can be Stored.....	45
When Placing an Original on the Glass	47
When Using the Reversing Automatic Document Feeder (optional).....	49
3. GENERAL COPYING PROCEDURES	52
4. AUTO JOB START (JOB PRESET)	55
5. INTERRUPT COPYING	57
6. STOPPING THE COPY OPERATION	58
7. BYPASS COPYING	59

1. SETTING COPY PAPER

Acceptable Copy Paper Types and Sizes

Feeder	Paper Type	Paper Size	Maximum sheet capacity
Drawers (The optional drawers included)	Plain Paper (64-80 g/m ²)	(Standard Size) A/B format: A3, A4, A4-R, A5-R, B4, B5, B5-R, FOLIO (210 x 330 mm) LT format:	600 sheets (64 g/m ²) 550 sheets (80 g/m ²) 450 sheets (81-105 g/m ²) * Height: approx. 60.5 mm
	Thick 1 (81-105 g/m ²)	LD (11" x 17"), LG (8 1/2" x 14"), LT (11" x 8 1/2"), LT-R (8 1/2" x 11"), ST-R (5 1/2" x 8 1/2"), COMP (10 1/8" x 14"), 13" LG (8 1/2" x 13"), 8.5" SQ (8 1/2" x 8 1/2"),	
Large capacity feeder (Option)	Plain Paper (64-80 g/m ²)	(Standard Size) A4 only	3,000 sheets (64 g/m ²) 2,500 sheets (80 g/m ²)
	Thick 1 (81-105 g/m ²)		2,000 sheets (81-105 g/m ²) * Height: approx. 137.5 mm
Bypass Guide	Plain paper (64-80 g/m ²)	(Standard Size) A/B format: A3, A4, A4-R, A5-R, A6-R, B4, B5, B5-R, FOLIO (210 x 330 mm) LT format:	100 sheets (64-80 g/m ²) * Height: approx. 11 mm
	Thick1 (81-105 g/m ²)	LD, LG, LT, LT-R, ST-R, COMP, 13" LG, 8.5" SQ, A3 wide (305 x 457 mm)	80 sheets (81-105 g/m ²) * Height: approx. 11 mm
	Thick2 (106-163 g/m ²)	(Non-Standard size) Length: 100-297 mm Width: 148-432 mm	40 sheets (106-163 g/m ²) * Height: approx. 11 mm
	Thick3 (164-209 g/m ²)		30 sheets (164-209 g/m ²) * Height: approx. 11 mm
	Sticker labels		* Height: approx. 11 mm * ¹
	OHP * ²	(Standard Size) A4 only	30 sheets * Height: approx. 11 mm

*1. Sticker labels can be copied with fine image if Thick 2 mode is selected.

*2. Automatic duplex copying is not available.

* "Maximum capacity" refers to the number of sheets when the paper recommended by Toshiba is set.

* LT format is the standard size for only use in North America.

* The values shown in the parenthesis are rounded off below a decimal point.

- Paper between 90-209 g/m² can be copied if the thick mode is used.

Toshiba-Recommended Paper/Handling and Storing Paper

The recommended paper

To make copies with a fine image, the following sheets are recommended.

If you use copy paper other than the recommended types, ask your service technician.

Paper Type	Toshiba Recommendation	Manufacturer
Plain Paper	TGIS Paper/Neusiedler	80 g/m ²
Thick 1	Colour Copy/Neusiedler	90 g/m ²
	Colour Copy/Neusiedler	100 g/m ²
Thick 2	Colour Copy/Neusiedler	120 g/m ²
	Colour Copy/Neusiedler	160 g/m ²
Thick 3	Colour Copy/Neusiedler	200 g/m ²
Sticker Labels	3478/ZWECK-AVERY	-
OHP Film	BG78/FOLEX (Colour)	-

* An OHP film should surely be used in the Toshiba-recommended film. Using other film may cause a malfunction.

Handling and Storing Paper

Pay attention to the following points:

- Avoid using paper that is specially treated or previously printed on another machine, and also avoid performing double copying on the same side of paper; this may cause a malfunction
- Do not use paper with creases, wrinkles, curled paper, paper prone to curling, smooth paper, or tough paper; this may cause paper misfeeds.
- Paper should be wrapped in its wrapping paper and stored in a damp-free place.
- To prevent paper from being folded or bent, store it evenly on a flat surface.

Changing the Paper Size of the Drawer/Setting the Drawer for Special Uses

The paper size of the drawer can be changed. The drawers can also be set for cover sheet, insertion, thick paper 1, Fax and special sheets.

2

Changing the Paper Size of the Drawer

- 1** Pull out the drawer carefully until it comes to a stop.

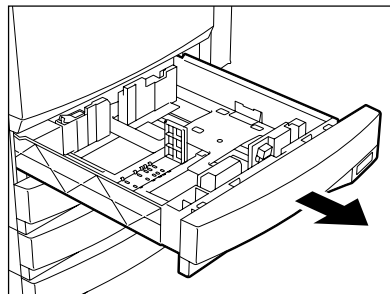

- 2** Push the lower part of the width guide in the direction of the arrow to remove it; then reinstall the width guide at the desired paper size (indicated on the bottom inner surface of the drawer).

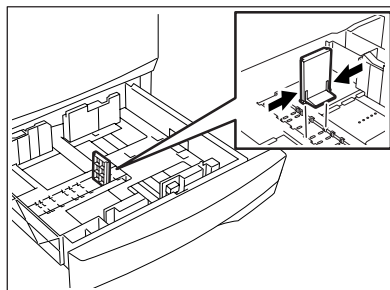

- 3** Push the arrow part (right side) of the size selection lever to unlock it.

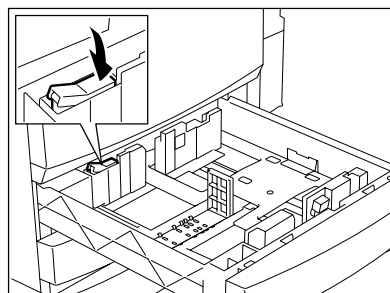

4 While pushing the size selection lever in the direction of the arrow, set the side guide to the desired paper size (indicated on the bottom inner surface of the drawer).

- Adjust the side guides with both hands.

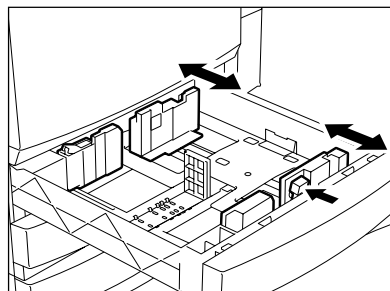

5 Push the arrow part (left side) to lock the size selection lever.

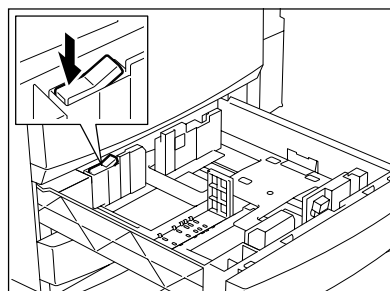

6 Place paper in the drawer(s).

- Place paper face up.
- Maximum number of sheets that can be set. "Acceptable Copy Paper Types and Sizes" Page 36
- Fan the paper well before placing it in the drawer.
- Do not add paper above the line indicated on the guide.
- Do not use creased, folded, wrinkled or damp sheets of paper.

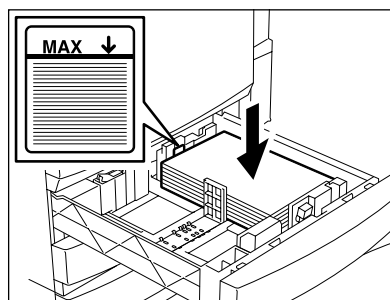

Note

Make sure that a gap of approx. 0.5 mm (less than 1 mm in total) is left between the paper and the side guide. If there is no gap, this could cause paper misfeeding.

7 Push the drawer straight into the copier until it comes to a stop.

- Be sure to push the drawer fully in.

Tip

Be careful not to let your fingers be caught when closing the drawer. This could injure you.

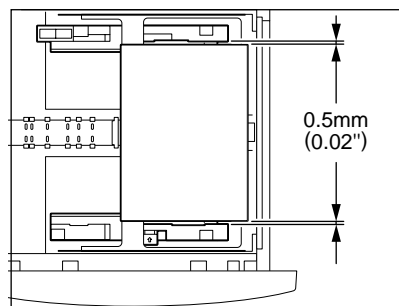

- 8** Change the size mark plate to match with the size of paper that has been set.

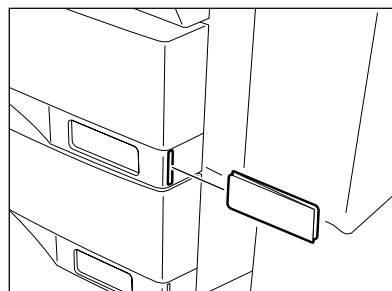

- 9** Press the [USER FUNCTIONS] button on the control panel.

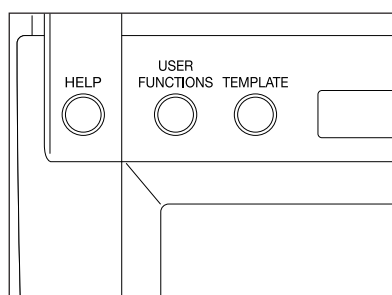

- 10** Press the [USER] button, then press the [GENERAL] button on the touch panel.

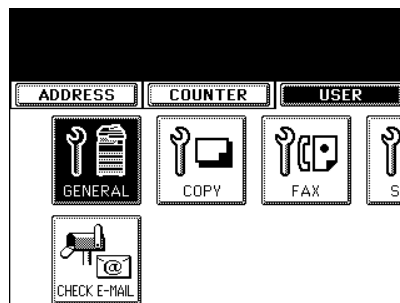

- 11** Press the [DRAWER] button.

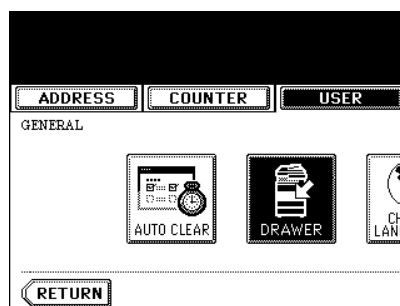

- 12** Press the drawer icon corresponding to the one which the paper size has been changed, and then press the button indicating the new paper size.

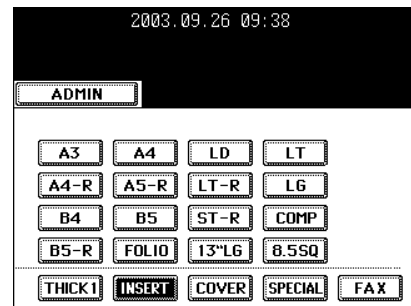
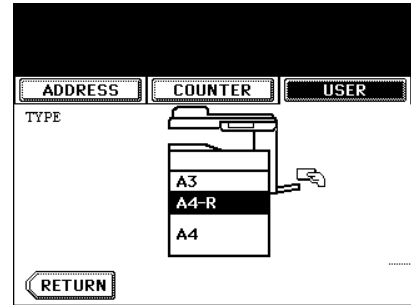

Setting the Drawer for Special Uses

You can set the drawer for various uses (cover sheet, sheet insertion, thick paper, Fax paper, special sheets).

- Acceptable copy paper "1.SETTING COPY PAPER" Page 36
- Drawer for cover sheet "9.COVER COPYING" Page 122
- Drawer for sheet insertion "10.SHEET INSERTION MODE" Page 125
- Drawer for special sheets. Coloured paper, paper with a watermark, etc.

- 1** Place paper face up in the drawer(s).
- 2** Press the [USER FUNCTIONS] button on the control panel.

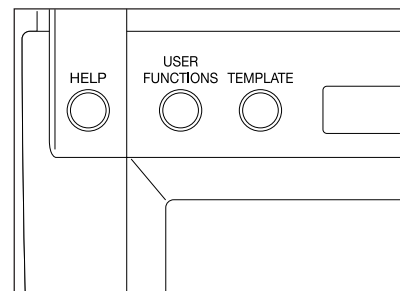

3 Press the [USER] button to enter the user menu and then press the [GENERAL] button.

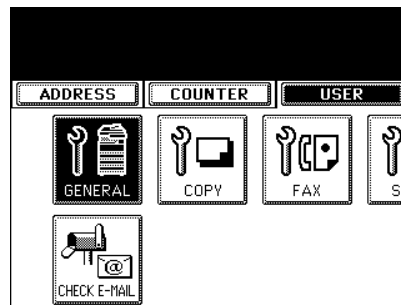

4 Press the [DRAWER] button.

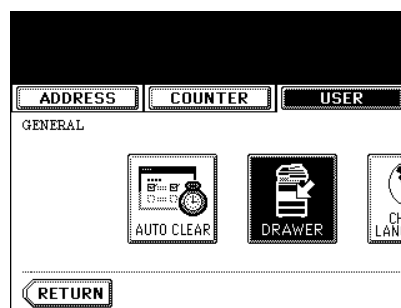

5 Press the drawer button corresponding to the one in which the paper size has been changed, and then press the button indicating the new paper type.

- If you want to select the [COVER] or [INSERT] button, make sure that paper with the same size as that for the COVER or INSERT is set in the other drawer including the optional large capacity feeder.

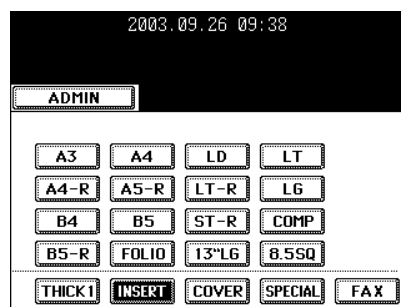
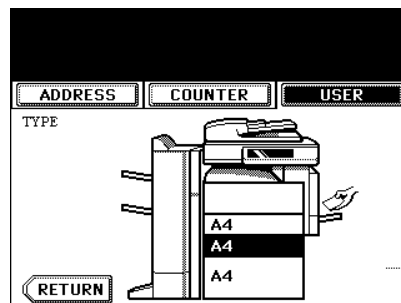

Tips

- Press [THICK 1] depending on the paper weight of the cover sheet, sheet insertion, and special sheet.

In the case of cover sheet or sheet insertion, \times_1 is displayed in the drawer button corresponding to the one in which the paper has been set.

- * For example, when inserting 90 g/m² paper, press the [INSERT] button, and press the [THICK 1] button.
- The setting is completed as shown on the right.

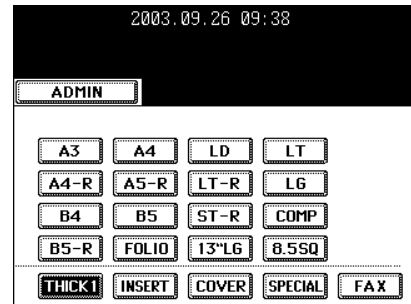
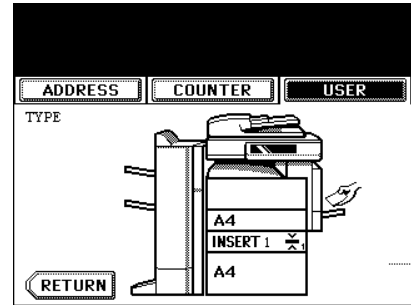

Tips

- 2 drawers can be set for the sheet insertion.
- After having set INSERT 1, press the drawer button corresponding to the one in which the paper for INSERT 2 has been set, and press the [INSERT] button.

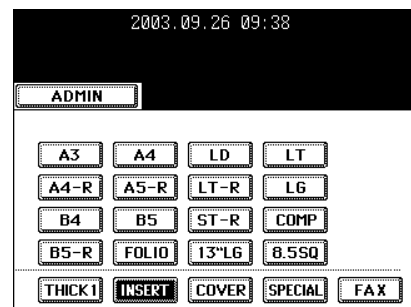
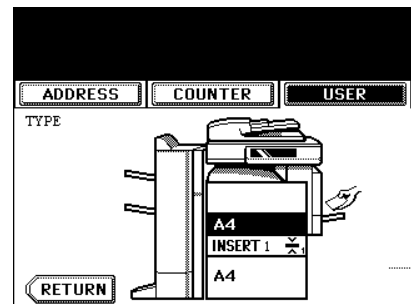

Clearing the Drawer for Special Uses

2

1 Press the drawer button corresponding to the one which is set for the special use, then press the corresponding button (thick, insert, cover, etc.) on the bottom line of the display.

- If you clear INSERT 1 when both INSERT 1 and INSERT 2 are set, the drawer for INSERT 2 changes to INSERT 1.
- Each of the buttons toggles the associated drawer on/off.
- Replace the paper set in the drawer as required.

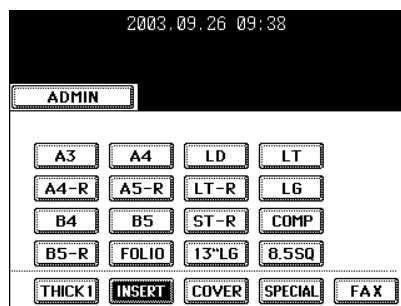
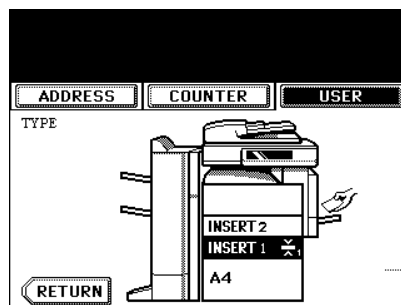

2. SETTING ORIGINALS

Acceptable Original Types and Sizes/Maximum Number of Sheets that can be Stored

Acceptable Original Types and Sizes

Setting place	Types of originals	Maximum size	Sizes capable of automatic detection
Glass *1	Sheets 3-dimensional objects Books	Width: 297 mm Length: 432 mm	(Standard size) A/B format: A3, A4, A4-R, A5-R, B4, B5, B5-R LT format: LD(11" x 17"), LG(8 1/2" x 14") LT(11" x 8 1/2"), LT-R(8 1/2" x 11") ST-R(5 1/2" x 8 1/2")
Reversing automatic document feeder (optional) *2	Plain paper Recycled paper: 1-sided Original: 50-127 g/m ² 2-sided Original: 50-105 g/m ²	Width: 297 mm Length: 432 mm	(Standard size) A/B format: A3, A4, A4-R, A5-R, B4, B5, B5-R, FOLIO (210 x 330 mm) LT format: LD, LG, LT, LT-R, ST-R, COMP (10 1/8" x 14") *3

*1. Do not place any heavy object (4 kg or over) on the glass.

*2. Even if listed under "Types of originals", some of the originals may not be used depending on paper quality.

*3. Automatic detection cannot be worked when the different paper formats are mixed.

* LT format is the standard size used in the North America.

* When the original of LT format is placed, the automatic detection may not work correctly.

Tip

Maximum number of sheets (all sizes) that can be set in the reversing automatic document feeder (optional): 100 sheets (50-80 g/m²) or less than 16 mm in height.

Maximum Number of Sheets that can be Stored

Up to 1,000 sheets of A4 size can be stored per 1 job, or until the memory becomes full.

When exceeding the above limit during the scanning, the following screen is displayed. The scanned data is printed by pressing the [YES] button and it is deleted by pressing the [NO] button.

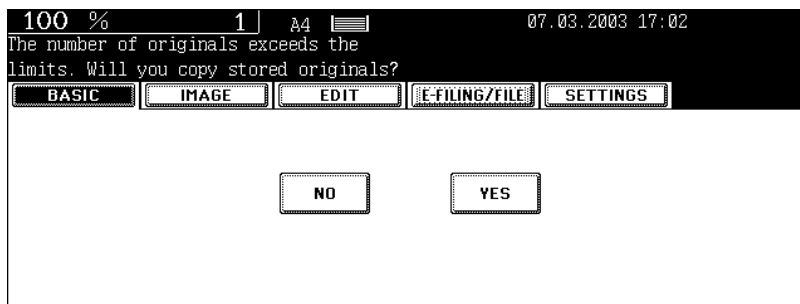

When Placing an Original on the Glass

Sheet Originals

1 Raise the original cover or the reversing automatic document feeder (optional), and place the original face down on the glass.

- Raise it 60 degrees or more for detecting the original.
- A: Original

2 Align the original against the left rear corner of the glass.

3 Lower the original cover or the reversing automatic document feeder (optional) slowly.

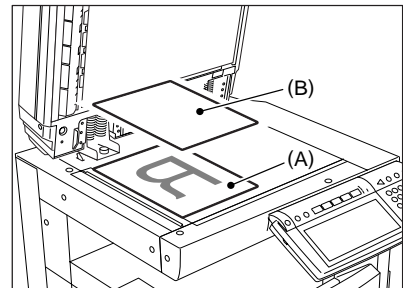
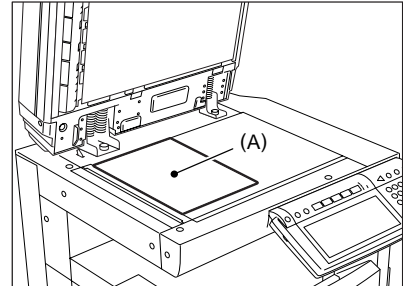

- When copying originals with high transparency, such as OHP films and tracing paper, place a blank sheet of paper, the size of the original or larger, over the original.
- A: Original
- B: Blank sheet



Book-type Originals

2

1 Raise the original cover or the reversing automatic document feeder (optional), and place the original in the direction shown in the illustration.

- When using the Book-type Originals->2-sided Copies ("5. Book-type Originals -> 2-Sided Copies"  Page 91) or the Dual-Page ("4.DUAL-PAGE"  Page 111) function, centre the book original on the yellow indicator line.

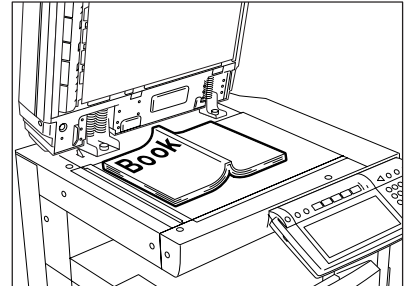

2 Lower the original cover or the reversing automatic document feeder (optional) slowly.

- Do not try to force the original cover or the reversing automatic document feeder to fully close over a very thick original, such as a big book. Copies can be made even if the cover or feeder does not close fully.
- During copying, an intense light may leak out. Do not look at the original glass surface.

When Using the Reversing Automatic Document Feeder (optional)

Precautions for Using the Reversing Automatic Document Feeder

Do not use the following type 1 to 8 of originals as they may misfeed or become damaged:

- 1 : Only originals with the same width can be set at a time. (Do not mix originals with different widths.)
- 2 : Badly wrinkled or folded originals; in particular, originals whose leading edge is curled may fail to be correctly fed.
- 3 : Originals with carbon paper
- 4 : Taped, pasted or clipped (cut out) originals
- 5 : Clipped or stapled originals
- 6 : Originals with holes or tears ones
- 7 : Damp originals
- 8 : OHP film originals

* Do not use tracing paper, permeable paper and coating paper (coating with wax, etc.).

Also, the following type 9 and 10 of originals should be handled carefully:

- 9 : Originals, 2 of which, when pinched between 2 fingers, cannot be moved, or originals that are surface-treated may fail to separate properly.
- 10: Folded or curled originals should be smoothed before being used.

* The different sized originals are limited for setting. "Mixed-sized Originals"  Page 70

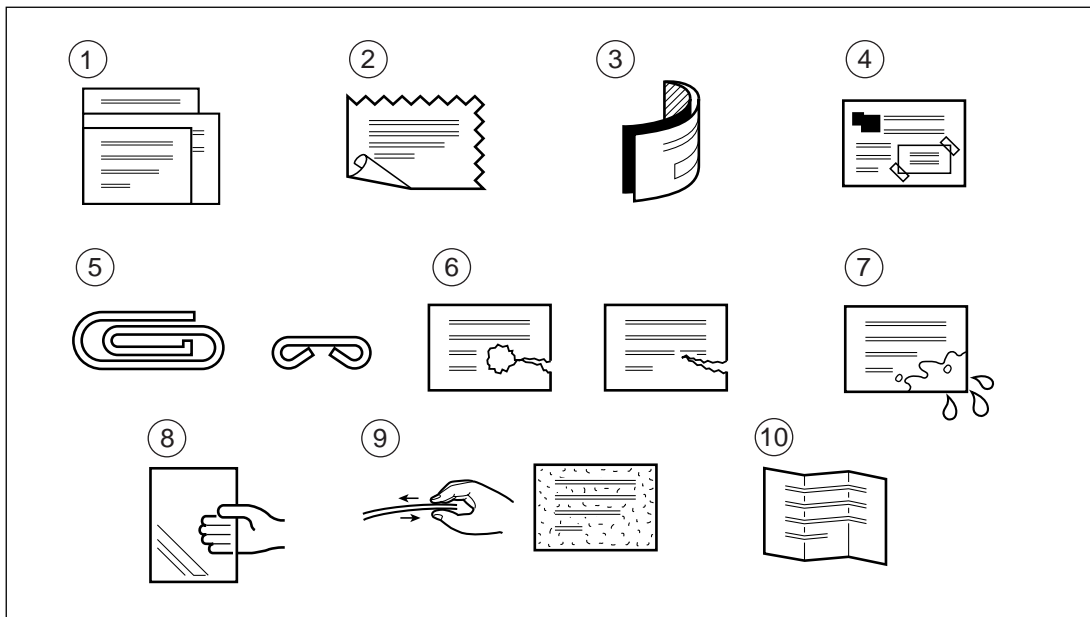



Tip

If the scanning area and guide area are dirty, it may cause black streaks, etc. on the printed paper. Cleaning them preferably once a week is recommended. See "Weekly Maintenance"  Page 284

2

In the Continuous Feed Mode

* See "Continuous Feed Mode"  Page 133

* To set originals with the different size, see "Mixed-sized Originals"  Page 70

1 After aligning the edges of originals, place the originals face up and align the slides to their width.

- Align the originals in order from the top because they will be fed from the top.
- One original sheet is also acceptable.
- Maximum number of sheets (all sizes) that can be set in the reversing automatic document feeder: 100 sheets (50-80 g/m²) or less than 16 mm in height.
- To set the mixed-sized originals, see "Mixed-sized Originals"  Page 70.
- Use the original stopper as required.

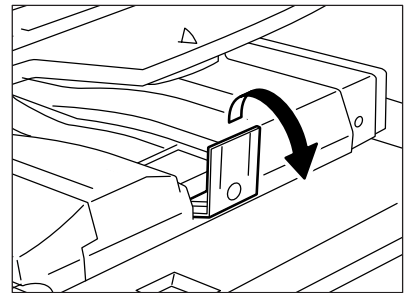
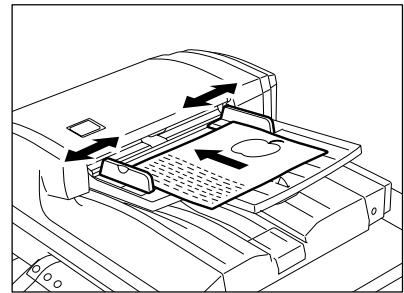
**Tip**

When the number of originals is too large to be set at one time, you can divide the originals into several sets and set them one after another. To do so, place the first set of originals first and press the [CONTINUE] button while the scanning is in progress. After they have been scanned, place the next set of originals.

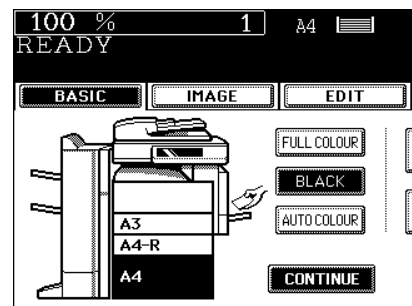

Inside the Single-feed Mode

See "Single-feed Mode"  Page 134

- 1** Align the slides to the desired original size.

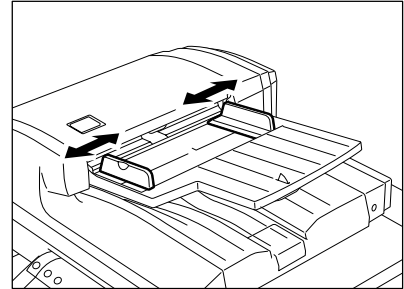

- 2** Insert the original with its face up and straight along the slides, it will be pulled in automatically.

- When the original starts being pulled in, let go of it.

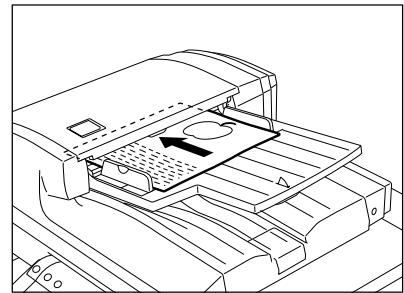

3. GENERAL COPYING PROCEDURES

After placing or confirming paper in the drawers, place the originals. When the [START] button is pressed with any settings unchanged, copies are made in the initial (default) settings. You can make copies as desired by setting different copy modes.

2

Initial (default) Settings



The copy modes that are automatically set when the power is turned on, when the energy-saving mode is cleared or when the [FUNCTION CLEAR] button is pressed on the control panel are called the initial (default) settings. The initial setting when installing the equipment is as follows:

* The initial setting can be changed. See the [User Function Guide] for details.

Item	Initial (default) setting
Black-and-white/colour mode	Black mode
Reproduction ratio	100%
Copy quantity	1
Paper selection	Automatic paper selection
Original -> Copy	1-sided -> 1 sided
Exposure	Auto Exposure
Image quality	TEXT/PHOTO mode
Finishing mode	Placing original on the original glass: Non-sort/non-staple mode Placing the reversing automatic document feeder (optional): Sort mode
Installing the reversing automatic document feeder (optional):	Continuous original feed mode



Copying Procedure

1 Place paper in the drawer(s).

- "Changing the Paper Size of the Drawer"  Page 38
- "Acceptable Copy Paper Types and Sizes"  Page 36

Tip

When the desired paper is not placed in any of the drawers or the large capacity feeder:

- Setting the drawer "Changing the Paper Size of the Drawer/ Setting the Drawer for Special Uses"  Page 38
- "Bypass Copying"  Page 59

2 Place the original(s).

- "Acceptable Original Types and Sizes/Maximum Number of Sheets that can be Stored" Page 45
- "When Placing an Original on the Glass" Page 47
- "When Using the Reversing Automatic Document Feeder (optional)" Page 49

Tip

When the reversing automatic document feeder (optional) is installed and the single feed mode is selected, place the original(s) after the copy mode is set.

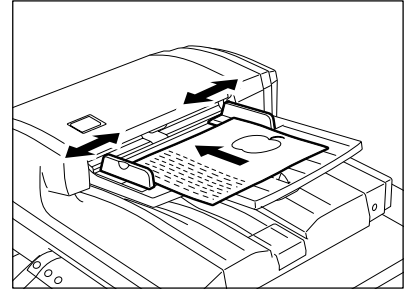

3 Select the copy modes as required.

- Copy modes cannot be changed after the [START] button is pressed (including the case when originals are divided into multiple sets when fed).
- Selecting multiple copy modes may be restricted depending on their combination.

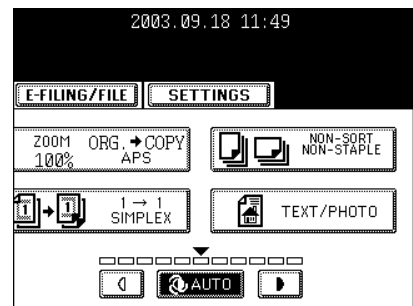
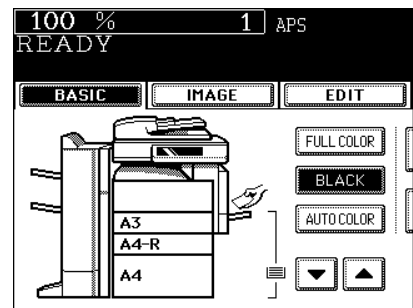

4 Press the [START] button.

- Copying starts.

Tip

To copy the original, which is placed on the original glass, after scanning and storing it in the memory (sort mode, 1-side original to 2-sided copies, etc.), follow step 5 and 6.

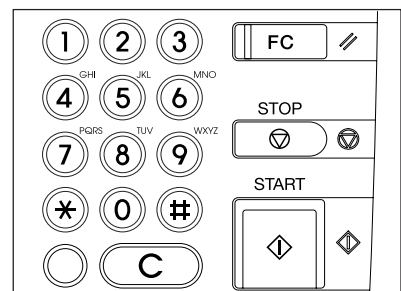

5 Place the next original, and press the [START] button.

- Set the first page of your originals first.
- You can also press the [YES] button to perform the same operation.
- Repeat this step for the subsequent originals.

6 Once the final original has been scanned, press the [FINISHED] button.

- Copying starts. The paper exits with its copied side down.

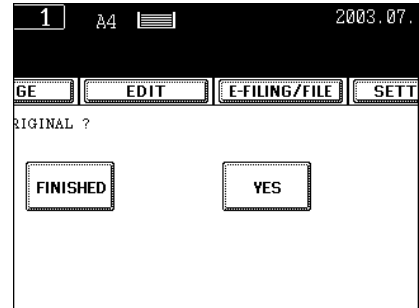

When Coming Across the Situations below

To make multiple sets of copies:

- Key in the copy quantity.
- To correct the input copy quantity, press the [CLEAR] button.
- Raise the stopper as required.

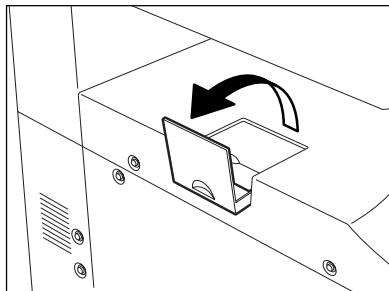

If the paper runs out in the middle of copying:

- The [JOB STATUS] button blinks. Press this button to check which drawer is flashing and add paper.

To stop a copy operation:

"6.STOPPING THE COPY OPERATION"  Page 58

When "Wait" appears:

The copier may automatically go into the adjustment mode. It will soon start working. Do not turn OFF the power. Just wait for a while.

4. AUTO JOB START (JOB PRESET)

While warming up or multi-copying, you can reserve the copy.

Setting Auto Job Start

- 1 Place the original(s).
- 2 Select the copy mode.

Tip

Be sure that the job starts in the previous copy mode if you do not select the copy mode.

- 3 Press the [START] button.

- Up to 6 jobs can be stored in the memory. Place the originals of the 6th job on the original glass or the reversing automatic document feeder (optional) and press the [START] button. Then "Auto Start" appears:
- Up to 1,000 sheets of A4 size can be stored per 1 job, or until the memory becomes full.

Tip

When exceeding the above limit (1,000 sheets of A4 size or full memory) during the scanning, the following menu is displayed. Press the [YES] button to print the scanned data and press the [NO] button to delete it.

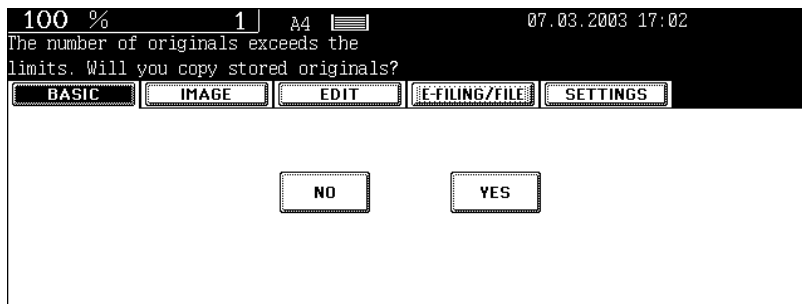
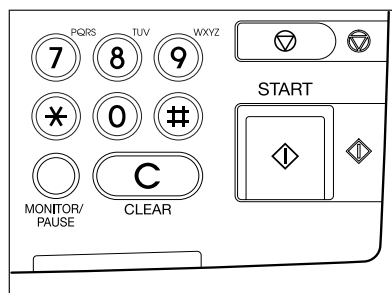

Confirming and Canceling Auto Job Start

- Confirming auto job start and canceling the job waiting to be copied.

Press the [JOB STATUS] button on the control panel to display the job list for confirming and canceling the data.

See "1.JOB STATUS"  Page 184 for canceling the job.

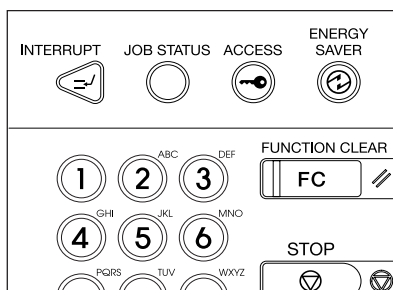

- Canceling auto job start.

Press the [STOP] button on the control panel to cancel the job during the scanning or in the status that the 6th job is being received to be stored.

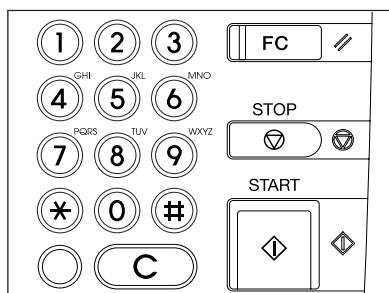

5. INTERRUPT COPYING

While multi-copying is in progress, you can interrupt and make copies from different originals.

* The following modes cannot be used with interrupt copying:

- Cover sheet copying
- Sheet insertion copying
- Scan to e-filing/Save as file

2

1 Press the [INTERRUPT] button.

- "Job interrupted job 1 saved" appears.
- Interrupt copying is available while copying is in progress.

Tip

When "Auto Start" is displayed, you cannot make interrupt copying.

2 Replace the original with a new one.

- "2.SETTING ORIGINALS"  Page 45

- Select other copy modes as required.

3 Press the [START] button.

4 After you have finished interrupt copying, press the [INTERRUPT] button again.

- "READY to resume job 1" appears.

Tip

Without performing step 4, the interrupt copying mode will automatically be cancelled by the automatic function clear and the previously interrupted copy job will resume in a certain period of time after the interrupt copying has finished.



6. STOPPING THE COPY OPERATION

If you want to stop the operation during scanning or multi-copying, the [STOP] button is used.

2

1 Press the [STOP] button on the operational panel during the scanning or multi-copying.

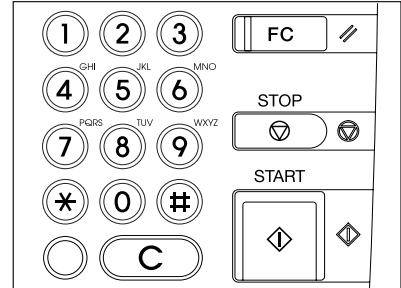

2 When the menu on the right is displayed, press the [MEMORY CLEAR] button.

- During scanning: the data is deleted.
- During multi-copying: the data is deleted and its operation stops.

Tip

If the waiting data remains, it starts to be outputted.

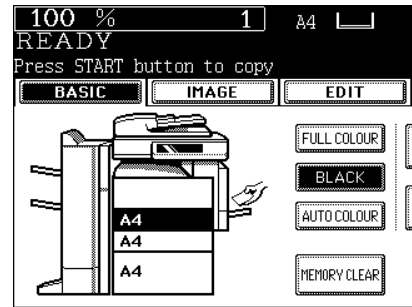

7. BYPASS COPYING

Bypass Copying

When you want to make copies on thick paper, OHP film, tracing paper, sticker labels or other special sheet, use the sheet bypass. (Only Thick 1 paper can be set in the drawer "Setting the Drawer for Special Uses"  Page 41).

If the desired size of paper (standard size) is not set in the drawers, or if you want to make copies on non-standard size paper, make bypass copies.

The modes below are available even in bypass copying if the paper size is specified:

- Dual-page
- Duplex copying
- Image shift
- Edge erase

In these cases, the setting procedures of the following 2 sizes of paper are different.

- Bypass copying on standard size paper
- Bypass copying on non-standard size paper "Bypass Copying on Non-Standard-Size Paper"  Page 62

* When copying is finished, the lamp of the [FUNCTION CLEAR] button lights. The bypass copying mode automatically returns to the default mode by pressing the [FUNCTION CLEAR] button or after a while the automatic function clear mode works and the settings will be cleared.

* The copier stops its operation when the paper set on the bypass guide has run out even if there is the same size of copy paper in the drawer. The copier starts again when adding the paper on the bypass guide.

Bypass Copying on Standard Size of Paper

1 Place paper on the bypass guide, and then holding the knob (A), align the guides with the size of the paper.

- "Ready for bypass feeding" appears.
- Acceptable paper type for bypass copy "Acceptable Copy Paper Types and Sizes"  Page 36
- Place the paper with the side to be copied facing down.
- If you put several sheets on the bypass guide at a time, fan the paper well before placing it.
- Place the paper so as not to exceed the line indicated on the guides.
- Do not push the paper forcibly into the entrance of bypass feeding. It may cause a paper jam.

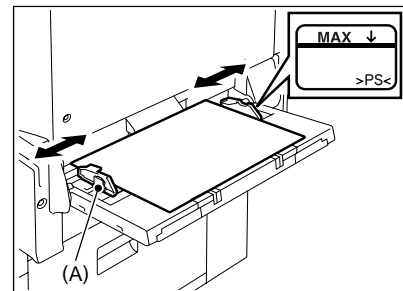

Tips

- Draw the triple paper holder depending on the paper size.
- Raise (B) before placing A3/LD size or larger.

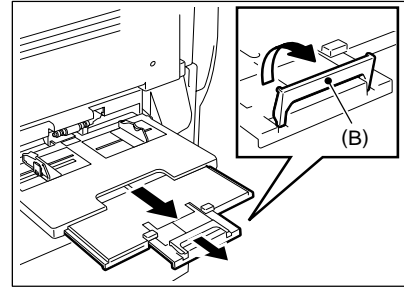
2 Place the original(s).**3 Press the button that represents the size of the paper that has been set for A3, A4, B4 and B5.****Tip**

When the paper size is not specified, the copying speed may be lower due to the cleaning operation inside the copier.

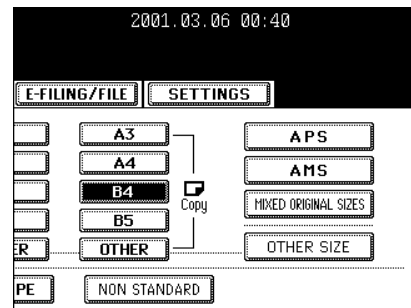
**4 When the standard size paper other than A3, A4, B4 and B5 is set, press the [OTHER SIZE] button.**

- See "Setting the [OTHER SIZE] button" Page 69.

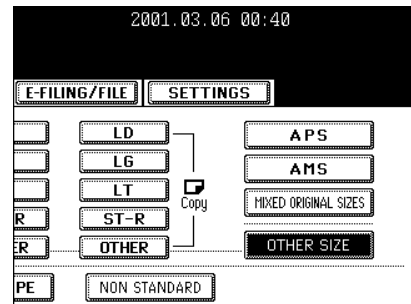
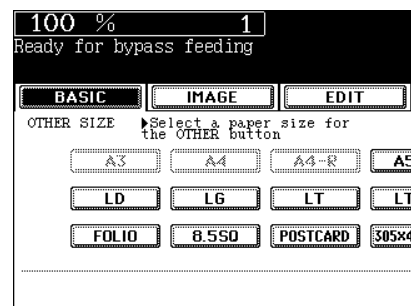
**5 Press the paper size key corresponding to the paper that has been set.**

6 Press the [OTHER] button.

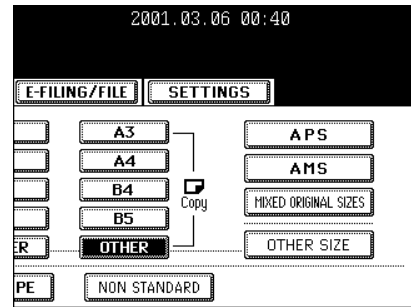

7 Press the [MEDIA TYPE] button when the paper other than plain paper is set.

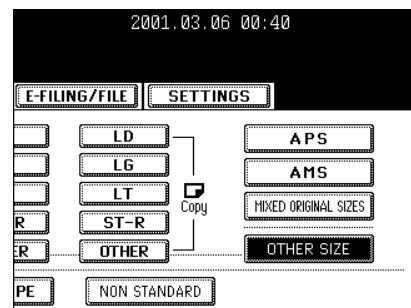

8 Select the media type corresponding to the paper that has been set, and then press the [ENTER] button.

Tip

If you select the media type not corresponding to the paper that has been set, it may cause a problem such as a paper jam, significant image deterioration, etc.

- Select other copy modes as required.

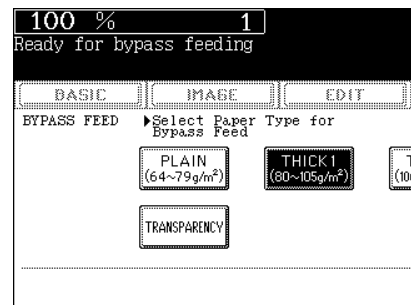

9 Press the [START] button.

Tip

When copying on OHP film, pick up copies one by one from the inner tray.

When the exited copies are piled up, they will have more curl and it may cause this OHP film cannot be projected property.

Bypass Copying on Non-Standard-Size Paper

Non-standard paper falls within the following ranges:

A (Length): 100-297 mm, B (Width): 148-432 mm

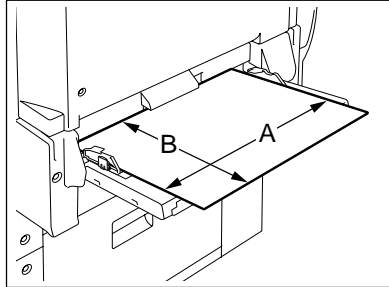

1 Follow steps 1 to 2 on "Bypass Copying"
 Page 59.

2 Press the [NON STANDARD] button.

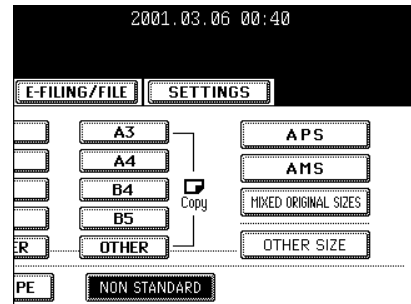

3 Key in each dimension (length and width),
 or recall the data stored in MEMORY, and
 then press the [ENTER] button.

- When using the digital keys to key in the size:
 Key in the length and press the [SET] button. Similarly, set the value for the width.

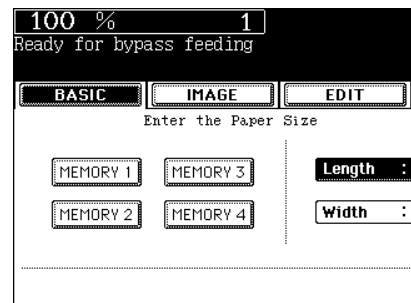

- Press the [MEMORY 1] (or [MEMORY 2], [MEMORY 3], [MEMORY 4]) button, the paper size memorized in the MEMORY 1 appears.

- Select other copy modes as required.

4 Press the [START] button.

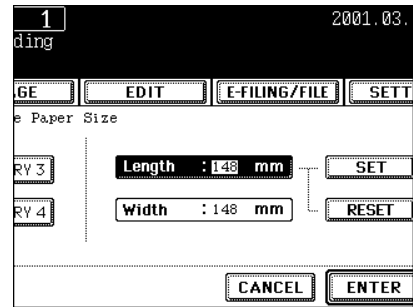

2

Storing a Non-Standard Size in MEMORY

It is convenient to store a frequently used non-standard-size paper in memory.

1 Follow steps 1 to 2 on "Bypass Copying" Page 59.

2 Press the [NON STANDARD] button.

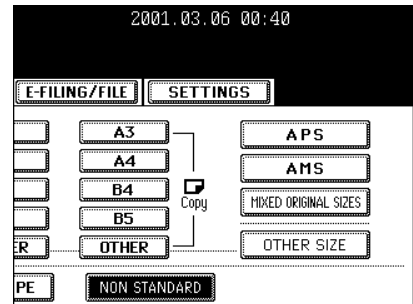

3 Press the desired memory number button.

- When the paper size is '0 mm', the selected memory number button is vacant.
- When the paper size is displayed, a non-standard size is already stored in the selected memory number. To delete the settings, follow step 4. New settings will be rewritten and stored on that memory number.

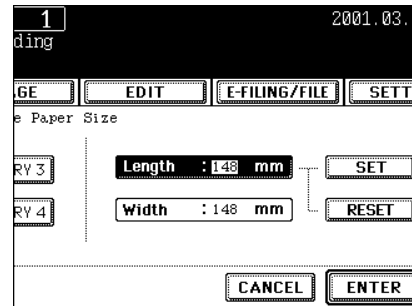
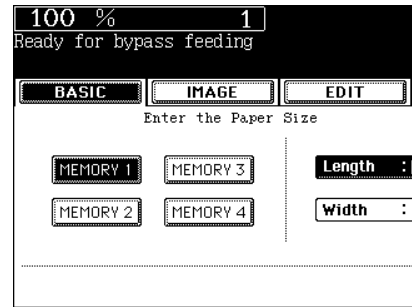

4 Key in each dimension using the digital keys, and then press the [MEMORY] button.

- Key in the length and press the [SET] button. Similarly, set the value for the width.
- The paper size is stored in the highlighted Memory Number.

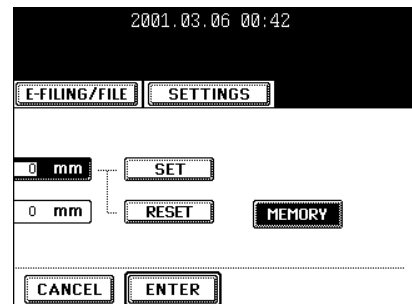

3. SETTING OF BASIC COPY MODES

1. PAPER SELECTION.....	66
Automatic Paper Selection (APS)	66
Manual Paper Selection	68
Setting the [OTHER SIZE] button	69
Mixed-sized Originals.....	70
2. BLACK-AND-WHITE/COLOUR COPY MODE SELECTION	71
3. REDUCTION AND ENLARGEMENT COPYING	72
4. SELECTING FINISHING MODES	76
Finishing Modes and Finishers (Optional)	76
Sort/Group Copying	78
Rotate Sort Mode.....	79
Staple Sorting.....	80
Magazine Sort & Saddle Stitch Mode (Booklet Mode)	82
Hole Punch Mode (Optional).....	85
5. DUPLEX COPYING	87
For Making 1-sided, 2-sided and Book-type Copies	87
6. ORIGINAL MODE	93
7. COPY DENSITY ADJUSTMENT	94

1. PAPER SELECTION

Automatic Paper Selection (APS)

When you place regular-sized originals on the glass or in the reversing automatic document feeder (optional), the size of the originals is automatically detected, which helps the copier select paper that is the same size as the originals.

- * Depending on the condition of the original, Automatic Paper Selection may not work correctly. In that case, select the paper size manually. "Manual Paper Selection" Page 68
- * This mode can only be used for actual-size (100%) copying.
- * Original sizes available for automatic detection "Acceptable Original Types and Sizes/Maximum Number of Sheets that can be Stored" Page 45

3

1 Place paper in the drawer(s).

- "1.SETTING COPY PAPER" Page 36

2 Place the original(s).

- "2.SETTING ORIGINALS" Page 45

3 Confirm that the automatic paper selection mode (default setting) is selected on the basic menu.

- If the automatic paper selection mode is not selected, press the [ZOOM...] button, and then press the [APS] button on the next screen.
- If "Change direction of original" and "CHANGE DRAWER TO CORRECT PAPER SIZE" appear, proceed as directed:

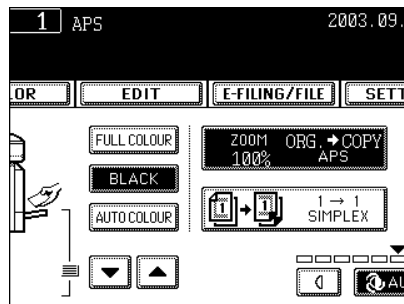
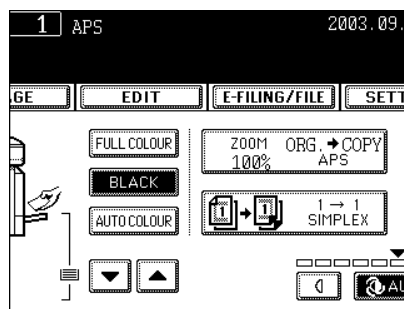

Tip

When the selected drawer size and the original size are the same, the copier rotates the original data by 90° and makes a copy which is the same size as the original --- even if those directions differ (e.g. an A4-size original is set while the same size paper is set in R direction).

- Select other copy modes as required.

4 Press the [START] button.

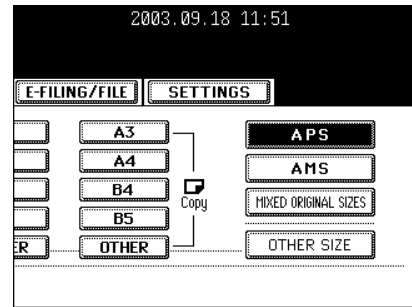

Manual Paper Selection

Automatic Paper Selection cannot be used for highly transparent originals such as OHP films and tracing paper, wholly dark originals or originals with dark borders, or irregular sized originals such as newspapers and magazines. For these types of originals, use manual paper selection.

* When the desired size of paper is not set in any of the drawers, you can change the paper size of the drawer ("Acceptable Copy Paper Types and Sizes" Page 36) or use the bypass copying ("Bypass Copying" Page 59)

3

1 Place paper in the drawer(s).

- "1.SETTING COPY PAPER" Page 36
- When using this mode in bypass copying "Bypass Copying" Page 59, be sure to specify the paper size.

2 Place the original(s).

- "2.SETTING ORIGINALS" Page 45

3 Press the drawer icon representing the desired paper size or select the paper size with button.

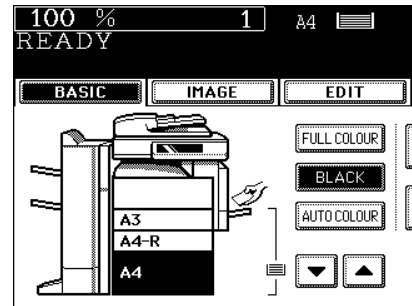

- Or press the [ZOOM...] button to enter the next screen, and press the button of the desired paper size.

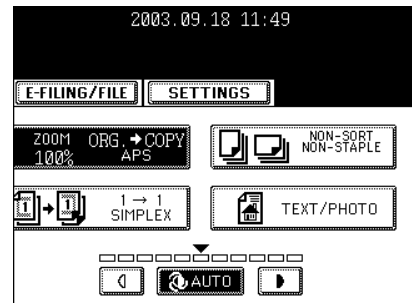

- "Setting the [OTHER SIZE] button" Page 69

- Select other copy modes as required.

4 Press the [START] button.

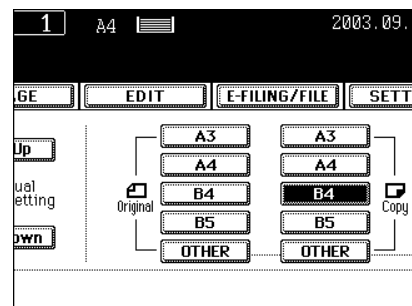

Setting the [OTHER SIZE] button

When the original or the paper size is specified and you want to use the paper size not displayed on the menu (except for non-standard size), press the [OTHER SIZE] button to select the size. This function allows the [OTHER] button to recognize the size you use.

- The initial setting for this button is COMP.

1 Press the [ZOOM...] button to enter the setting menu of the original or paper size, and then press the [OTHER SIZE] button.

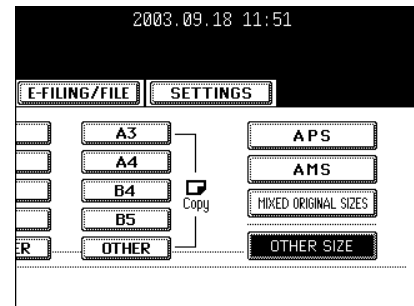

2 Press the [PAPER SIZE] button of the paper corresponding to the size that will be used.

- If you select 'LT', the [OTHER] button (for both the original and the paper size) is recognized as LT size.

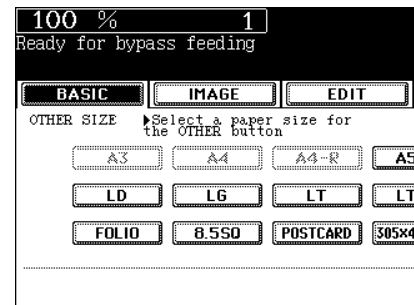

Mixed-sized Originals

When the optional reversing automatic document feeder is used, different size originals can be copied at a time in this mode if the widths of the originals are the same.

* Do not set originals whose widths are different.

1 Place paper in the drawer(s).

- "1.SETTING COPY PAPER"  Page 36
- Bypass copying is not available.

2 Place the original(s).

- "2.SETTING ORIGINALS"  Page 45
- A3 and A4, B4 and B5, FOLIO and A4-R, LD and LT or LG and LT-R sized originals can be mixed.

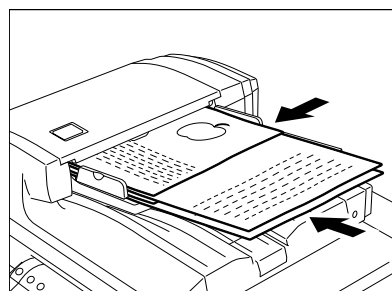

3 Press the [ZOOM...] button to enter the setting menu of the original or paper size.

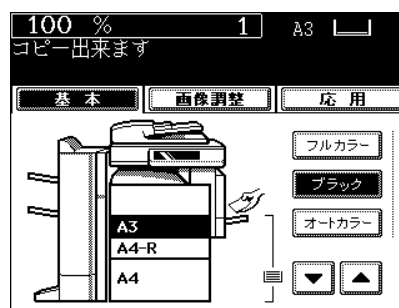

4 Press the [MIXED ORIGINAL SIZES] button.

5 Select either the Automatic Paper Selection ("Automatic Paper Selection (APS)" Page 66) or Automatic Magnification Selection mode ("Automatic Magnification Selection (AMS)" Page 72)

- To make duplex copying, select the automatic magnification mode.

- Select other copy modes as required.

6 Press the [START] button.

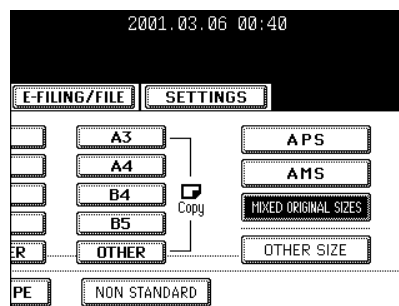

2. BLACK-AND-WHITE/COLOUR COPY MODE SELECTION

This function allows you to select the Full colour mode, the Black mode and the Auto colour mode.

1 Press the [FULL COLOUR], [BLACK] or [AUTO COLOUR] button.

- [FULL COLOUR]: Regardless of colour, all originals are colour-copied.
- [BLACK]: Regardless of colour, all originals are copied in black-and-white (default setting).
- [AUTO COLOUR]: The type of original is automatically distinguished. Coloured originals are colour-copied and black-and-white originals are copied in black-and-white.

Tip

When using the "AUTO COLOUR" mode, pay attention to the following points.

- In the "AUTO COLOUR" mode, if the colour area is too small or the colours are close to black or they are too light, colour originals may be copied in black-and-white. In this case, select the "FULL COLOUR" mode. Yellowish originals or originals with a coloured background may be automatically copied in colour even though they are black-and-white. To be sure to make the copies in the desired mode, select "FULL COLOUR" or "BLACK".

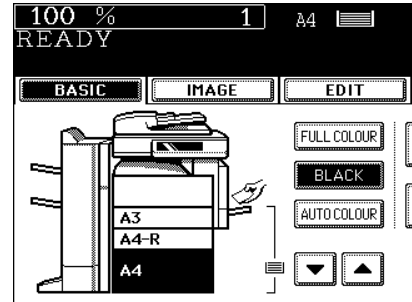

3

3. REDUCTION AND ENLARGEMENT COPYING

3

When placing originals on the original glass, you can copy them at the reducing and enlarging rate of 25 to 400%. For the reversing automatic document feeder (optional), you can make copy at the reducing and enlarging rate of 25 to 200%.

There are 3 ways of making copies in the Reduction and Enlargement mode:

- Using Automatic Magnification Selection (AMS)
- Specifying both original size and copy size separately
- Using the reduction/enlargement zoom buttons or the one-touch zoom buttons

* Automatic Magnification Selection cannot be used for highly transparent originals such as OHP films and tracing paper, wholly dark originals or originals with dark borders, or irregular sized originals such as newspapers and magazines. For these types of originals, use the other reduction/enlargement modes. Original sizes available for Automatic Magnification Selection (automatic detection) "Acceptable Original Types and Sizes/Maximum Number of Sheets that can be Stored" Page 45

* Set the paper size for the "OTHER" button as required ("Setting the [OTHER SIZE] button" Page 69). When the set originals or paper are a non-standard size other than A3, A4, B4 or B5, you will select the [OTHER] button on the screen of step 3 below. Before pressing it, you need to make the [OTHER] button recognize the same size as the originals or paper that have been set.

Automatic Magnification Selection (AMS)

1 Place paper in the drawer(s).

- "1.SETTING COPY PAPER" Page 36

2 Press the desired drawer (or , button), and then press the [ZOOM] button.

- The copy paper size is selectable on the menu in step 3 as well.

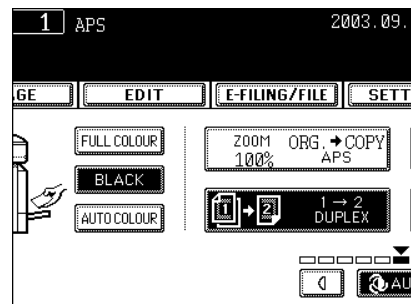
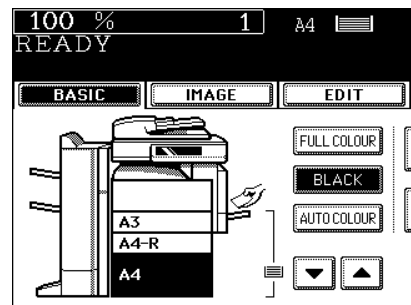

3 Press the [AMS] button.

- "Setting the [OTHER SIZE] button" Page 69

4 Place the original(s).

- "2.SETTING ORIGINALS" Page 45
- The built-in sensors automatically detect the size of the original(s) and compute the reproduction ratio with the specified paper size respectively.
- If "Change direction of original" appear, proceed as directed:

- Select other copy modes as required.

5 Press the [START] button.

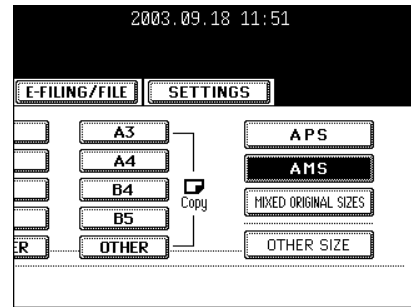

Specifying Both Original Size and Copy Size

1 Place paper in the drawer(s).

- "1.SETTING COPY PAPER" Page 36

2 Place the original(s).

- "2.SETTING ORIGINALS" Page 45

3 Press the desired drawer (or , button), and then the [ZOOM] button.

- The copy paper size is selectable on the menu in step 4 as well.

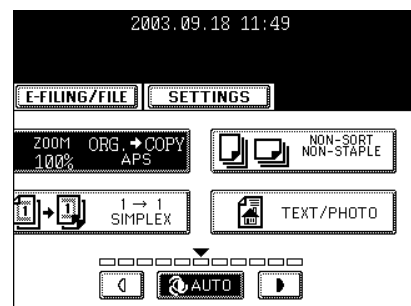
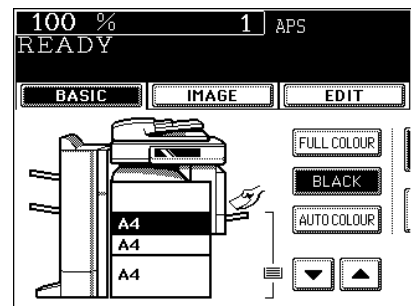

4 Press the [ORIGINAL SIZE] button that represents the size of the original.

- Using the original size and copy size, the correct reproduction ratio is computed and displayed on the screen.
- "Setting the [OTHER SIZE] button" Page 69
- Select other copy modes as required.

5 Press the [START] button.

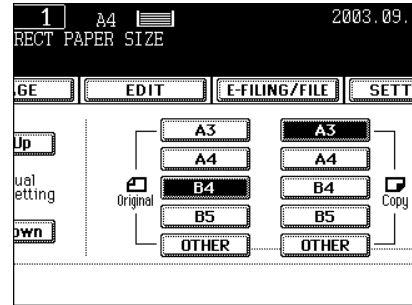

Using the Reduction/Enlargement Zoom Buttons or One-touch Zoom Buttons

1 Place paper in the drawer(s).

- "1.SETTING COPY PAPER" Page 36

2 Place the original(s).

- "2.SETTING ORIGINALS" Page 45

3 Press the drawer icon (or , button) representing the desired copy paper size, and then press the [ZOOM] button.

- The copy paper size is selectable on the screen in step 4 as well.

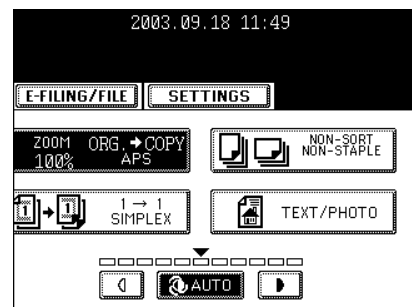
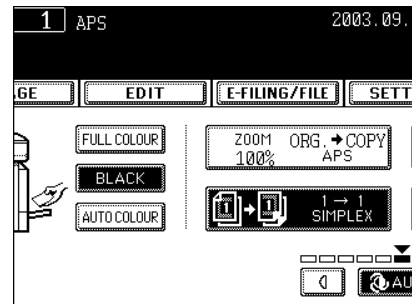

4 Press the [UP] (or [DOWN]) button to set the desired reproduction ratio.

- Each time you press either button, the reproduction ratio changes by 1%. Holding down the button changes it continuously.
- You can select the reproduction ratio by pressing the [400%], [200%], [100%], [50%] or [25%] button directly. (When placing the originals on the reversing automatic document feeder (optional), you cannot select [400%] button.)
- "Setting the [OTHER SIZE] button"  Page 69

- Select other copy modes as required.

5 Press the [START] button.

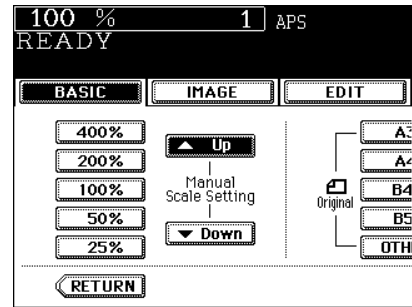

4. SELECTING FINISHING MODES

Finishing Modes and Finishers (Optional)

The functions available differ depending on whether a finisher is installed and which type of finisher (MJ-1022, MJ-1023 and MJ-1024) it is.

* The touch panel used in this chapter appears when the optional saddle-stitch finisher (MJ-1024) with hole punch unit (MJ-6004) is installed in your copier.

3

Type of Finishing Mode

- MJ-1024: Saddle-stitch finisher
- MJ-1023: Multi-staple finisher
- MJ-1022: Single-staple finisher
- MJ-6004: Hole punch unit

Confirm the finishing mode type of your equipment with the following table.

Y: Available

N: Not available

Finishing	Type of finishing mode						
	Sort/ Group	Rotate sort	Staple sort	Magazine sort	Magazine sort + Saddle stitch	Saddle stitch	Hole punch
MJ-1024 + MJ-6004	Y	Y	Y	Y	Y	Y	Y
MJ-1024	Y	Y	Y	Y	Y	Y	N
MJ-1023 + MJ-6004	Y	Y	Y	Y	N	N	Y
MJ-1023	Y	Y	Y	Y	N	N	N
MJ-1022	Y	Y	Y	Y	N	N	N
No finisher	Y	Y	N	Y	N	N	N

Names of each Finisher (Optional)

- 1: Trays
- 2: Upper cover
- 3: Hole punch unit (MJ-6004)
- 4: Front cover
- 5: Saddle stitch tray

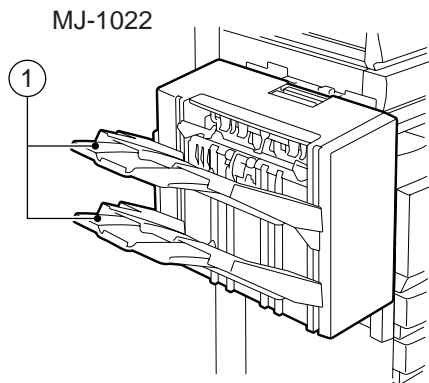
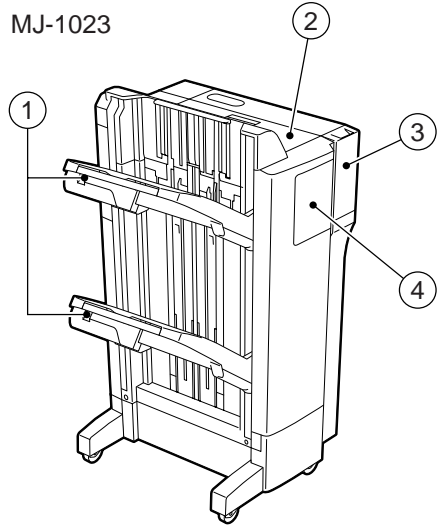
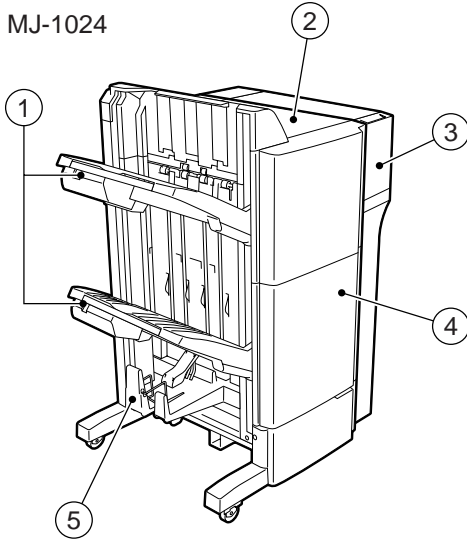

Tip

When the finisher trays reach their maximum loading capacity ("2.SPECIFICATIONS OF OPTIONS"  Page 293), "Remove paper from the finisher" appears. Remove the copied paper from the trays and the copier automatically resumes making copies.

Sort/Group Copying

To make multiple copies, you can select the sort mode or group mode as necessary.

- Example of making 5 sets of copies from 5-page originals

- 1: Sort copying
- 2: Group copying

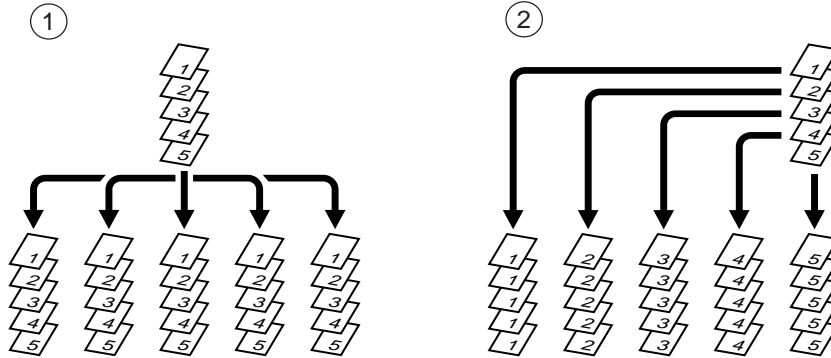

3

1 Place paper in the drawer(s).

- "1.SETTING COPY PAPER" Page 36

2 Place the original(s).

- "2.SETTING ORIGINALS" Page 45

3 Press the Finisher button on the basic menu as shown in the illustration on the right (highlighted).

Tip

When originals are placed in the reversing automatic document feeder (optional), the sort mode is automatically selected.

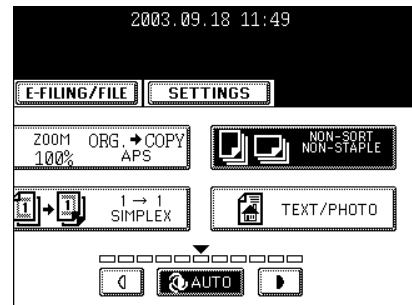

4 Press the [SORT] (or [GROUP]) button.

- Select other copy modes as required.

5 Press the [START] button.

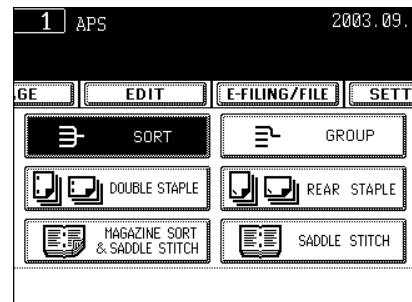

Rotate Sort Mode

In this copying mode, as sets of copies are output to the internal tray, the sets are alternated -lengthwise and crosswise- on top of each other. (Optional drawer or Stack Feeder Bypass is required.) A4/A4-R, B5/B5-R, LT/LT-R paper is available in this mode.

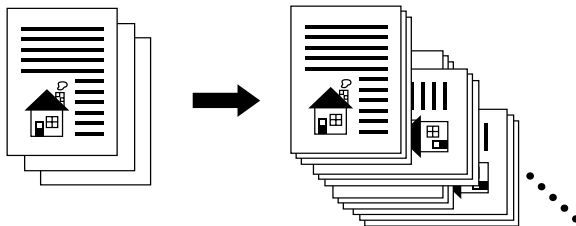

* This mode cannot be used in the Automatic Paper Selection mode.

3

1 Place paper in the drawer(s).

- "1.SETTING COPY PAPER" Page 36

2 Place the original(s).

- "2.SETTING ORIGINALS" Page 45

3 Press the Finisher button on the basic menu as shown in the illustration on the right (highlighted).

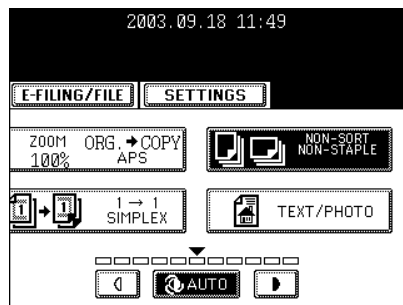

4 Press the [ROTATE SORT] button.

• Select other copy modes as required.

5 Press the [START] button.

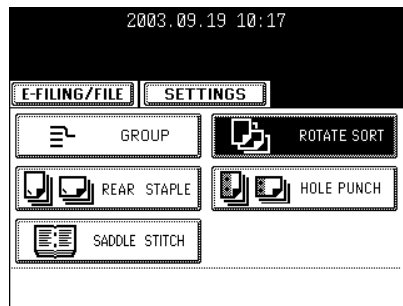

Staple Sorting

When the finisher (optional) is installed, you can perform automatic stapling for every set. 3 staple positions can be selected when installing saddle-stitch finisher (MJ-1024) or multi-staple finisher (MJ-1023).

- * The paper weight should be in the range of 64-105 g/m² for the saddle-stitch finisher (MJ-1024) or multi-staple finisher (MJ-1023), and 64-80 g/m² for the single-staple finisher (MJ-1022). Special paper such as OHP films or labels is excluded.
- * Stapling will not work when copied paper of different widths are mixed.

3

- Example of selecting the [FRONT STAPLE-1] button

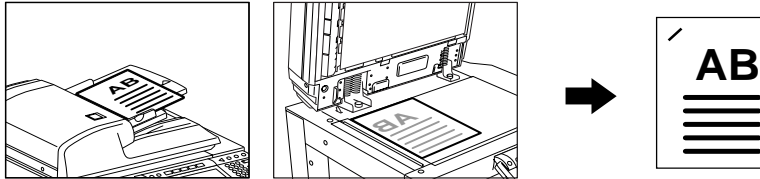

Setting Staple Sort Mode

1 Place paper in the drawer(s).

- "1.SETTING COPY PAPER" Page 36
- When using this mode in bypass copying ("Bypass Copying" Page 59), be sure to specify the paper size.

2 Place the original(s).

- "2.SETTING ORIGINALS" Page 45

3 Press the Finisher button on the basic menu as shown in the illustration on the right (highlighted).

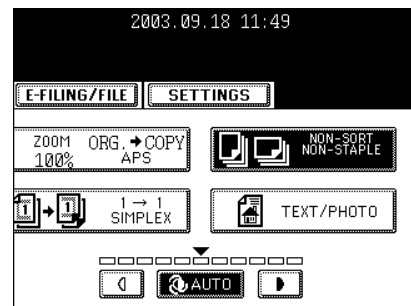

4 Press the [FRONT STAPLE-1] (or [DOUBLE STAPLE], [REAR STAPLE]) button.

- Only the [FRONT STAPLE-1] button is available when installing the single-staple finisher (MJ-1022).

- Select other copy modes as required.

5 Press the [START] button.

Tip

If the paper quantity exceeds the maximum number of sheets that can be stapled, the finisher automatically enters the sort mode.

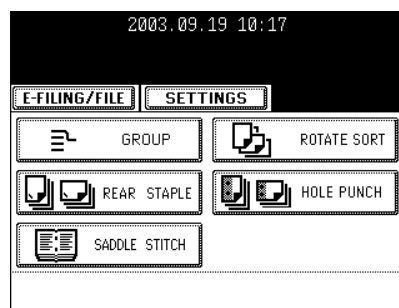
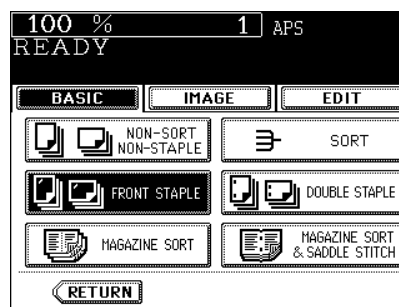

Maximum Number of Sheets that can be Stapled

- Saddle-stitch finisher (MJ-1024) and multi-staple finisher (MJ-1023)

When Plain paper and Thick 1 paper are loaded, the maximum number of sheets that can be stapled is the same as that of Thick 1 paper.

Paper size	Paper type (weight)	
	Plain paper (64-80 g/m ²)	Thick 1 (81-105 g/m ²)
A4, B5, LT	50 sheets	30 sheets
A3, A4-R, B4, FOLIO, LD, LG, LT-R	30 sheets	15 sheets

- Single-staple finisher (MJ-1022)

Paper size	Paper type (weight)
	Plain paper (64-80 g/m ²)
A4, A4-R, B5, LT, LT-R	30 sheets
B4, LG	20 sheets
A3, FOLIO, LD, COMP	15 sheets

* Tray load capacity "2.SPECIFICATIONS OF OPTIONS" Page 293

Magazine Sort & Saddle Stitch Mode (Booklet Mode)

When the Magazine Sort mode is selected, 1-sided originals can be copied and bound like magazines or booklets. When the saddle-stitch finisher (optional, MJ-1024) is installed, you can select the saddle stitch mode that will automatically fold and staple the centre of the document. A3, A4-R, B4, LD, LG and LT-R are available.

- * Special paper such as OHP films or labels is excluded.
- * The paper weight should be in the range of 64-105 g/m².
- When [MAGAZINE SORT] is selected

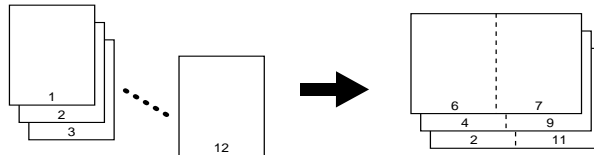

- When [MAGAZINE SORT & SADDLE STITCH] is selected

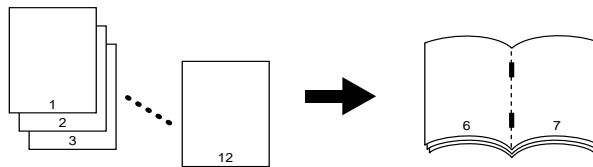

- When [SADDLE STITCH] is selected

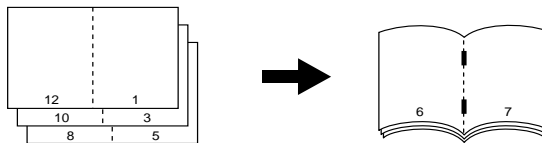

- * You can also select the Magazine Sort mode from the edit menu. "6.MAGAZINE SORT (FROM THE EDITING MENU)" 📖 Page 116
- * When placing the portrait original in short edge feed direction in the reversing automatic document feeder, copies can be made correctly with Image Direction setting. See "13.DIRECTION OF COPY IMAGES IN "1 TO 2" AND "2 TO 1"" 📖 Page 130.

Setting Magazine Sort & Saddle Stitch Mode

1 Place paper in the drawer(s).

- "1.SETTING COPY PAPER" 📖 Page 36

2 Set the paper size.

- For drawer feeding "Manual Paper Selection" Page 68, step 3
- For bypass feeding "Bypass Copying on Standard Size of Paper" Page 59, step 4

3 Place the original(s).

- "2.SETTING ORIGINALS" Page 45
- When placing originals in the reversing automatic document feeder (optional), set them by referring to the order of previous pages in the illustrations.
- When placing them on the glass, place the first page of the originals first if the [MAGAZINE SORT] or the [MAGAZINE SORT & SADDLE STITCH] is selected. If the [SADDLE STITCH] is selected, set them in the order of pages 12-1, (2-11), 10-3 (4-9), then 8-5, (6-7) by referring to the illustration above as an example.

4 Press the Finisher button on the basic menu as shown in the illustration on the right (highlighted).

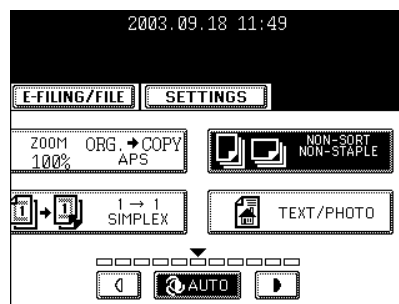

5 Press the [MAGAZINE SORT] (or [MAGAZINE SORT & SADDLE STITCH] or [SADDLE STITCH]) button.

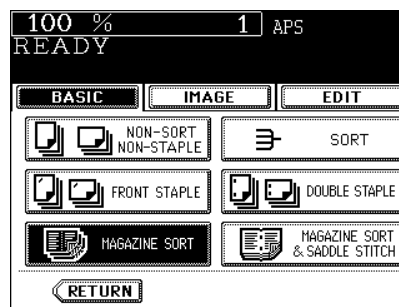

Tip

When the saddle stitch mode is used for A3, B4 and LD size, that is, when the [MAGAZINE SORT & SADDLE STITCH] button or the [SADDLE STITCH] button is selected, raise the stopper of the saddle stitch tray.

- Select other copy modes as required.

6 Press the [START] button.

- When placing original(s) on the glass, follow steps 5 to 6 on page "When Coming Across the Situations below" Page 54.

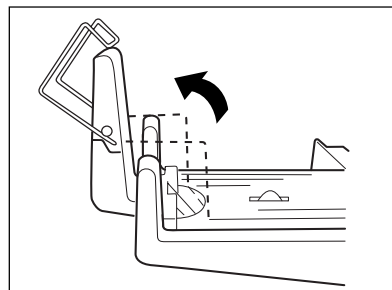

Available Conditions for Saddle Stitch

- A cover of 64-209 g/m² can be added. In this case, the cover is included in the maximum capacity for saddle stitch.
- When paper of different weights is loaded, the maximum number of sheets that can be stapled is that of the paper with the highest weight.

3

Paper size	Paper weight	Maximum capacity for saddle stitch	Tray load capacity
A3, A4-R, B4, LD, LG, LT-R	Plain paper 64 g/m ²	15 sheets	Copying of 11-15 sheets: 10 sets Copying of 6-11 sheets: 20 sets Copying of 5 sheets or less: 25 sets
	Plain paper 80 g/m ²	15 sheets	Copying of 11-15 sheets: 10 sets Copying of 6-11 sheets: 20 sets Copying of 5 sheets or less: 25 sets
	Thick 1 90 g/m ²	10 sheets	Copying of 6-11 sheets: 15 sets (Adding a cover: 5 sets) Copying of 5 sheets or less: 25 sets (adding a cover: 5 sets)
	Thick 1 105 g/m ²	10 sheets	Copying of 6-10 sheets: 15 sets (Adding a cover: 5 sets) Copying of 5 sheets or less: 25 sets (Adding a cover: 5 sets)

* The tray load capacity for the weight of 64 g/m² and 80 g/m² is not changed when a cover is added.

Hole Punch Mode (Optional)

When the optional hole punch unit is attached to the finisher (Optional: MJ-1024, MJ-1023), you can hole punch your copies.

* The paper weight should be in the range of 64-209 g/m². Special paper such as OHP files or labels is excluded.

1 Place paper in the drawer(s).

- "1.SETTING COPY PAPER" Page 36
- When using this mode in bypass copying ("Bypass Copying" Page 59), be sure to specify the paper size.

2 Place the original(s).

- "2.SETTING ORIGINALS" Page 45

3 Press the Finisher button on the basic menu as shown in the illustration on the right (highlighted).

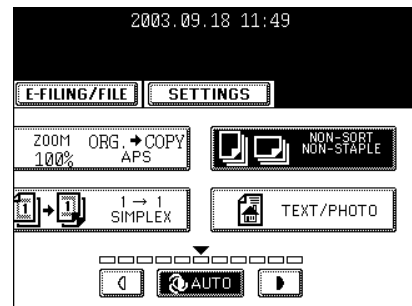

4 Press the [HOLE PUNCH] button.

- Select other copy modes as required.

5 Press the [START] button.

Tip

Available paper sizes for the hole punch:
Since the number of punch holes and the distance between the holes vary depending on the country, purchase a hole punch unit that meets your requirements. (For details, consult your service technician.)

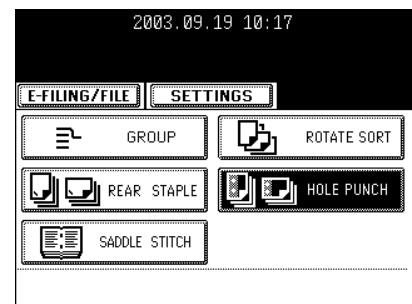

	Number of punch holes and hole diameter	Available paper sizes
Japan and most of Europe (MJ-6004E)	2 holes (6.5 mm dia.)	A3, A4, A4-R, B4, B5, B5-R, FOLIO, LD, LG, LT, LT-R, COMP
North America (MJ-6004N)	2/3 holes switchable (8.0 mm dia.)	2 holes: A4-R, LG, LT-R 3 holes: A3, A4, LD, LT
France (MJ-6004F)	4 holes (6.5 mm dia.: 80 mm pitch)	A3, A4, LD, LT
Sweden (MJ-6004S)	4 holes (6.5 mm dia.: 70.21 mm pitch)	A3, A4, A4-R, B4, B5, B5-R, FOLIO, LD, LG, LT, LT-R, COMP

* The paper mentioned above is Toshiba-recommended paper. Specifications and appearance are subject to change without notice in the interest of product improvement

5. DUPLEX COPYING

For Making 1-sided, 2-sided and Book-type Copies

This function allows you to set the type of originals (1-sided, 2-sided or book-type) and the desired type of copying (1-sided or 2-sided). Duplex copying is available for the plain paper (64-80 g/m²) and thick 1 paper (81-105 g/m²).

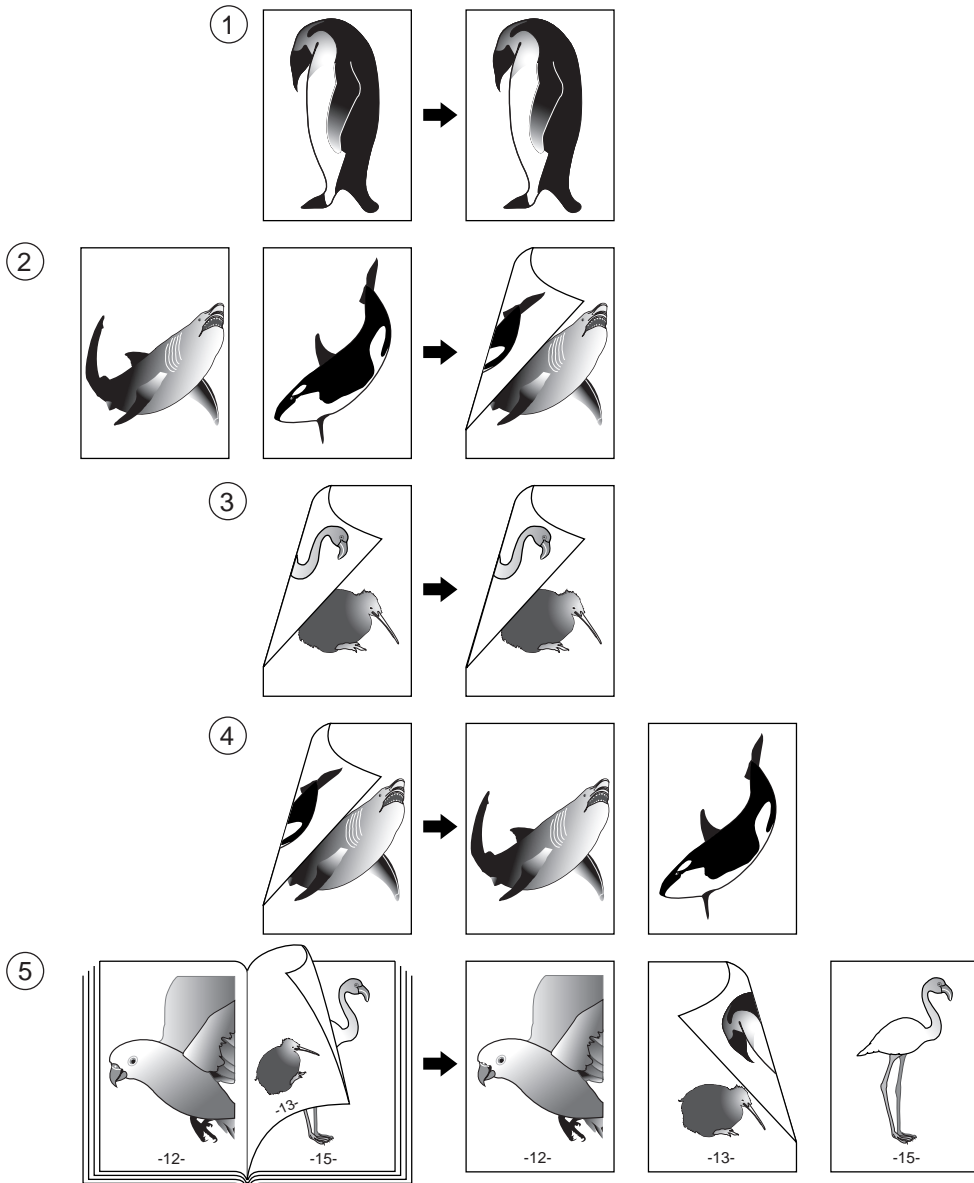

1. 1-Sided Originals -> 1-Sided Copies (default setting)

1 Place paper in the drawer(s).

- "1.SETTING COPY PAPER" Page 36

2 Place the original(s).

- "2.SETTING ORIGINALS" Page 45

3 Confirm that the [1 → 1 SIMPLEX] mode is selected in the basic menu.

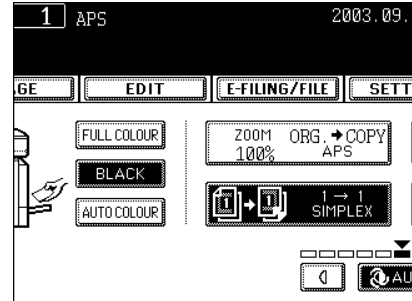

- If the "1-SIDED → 1-SIDED" mode is not selected, press the button (highlighted) in the menu on the right, and then press the [1 → 1 SIMPLEX] button on the next screen.

- Select other copy modes as required.

4 Press the [START] button.

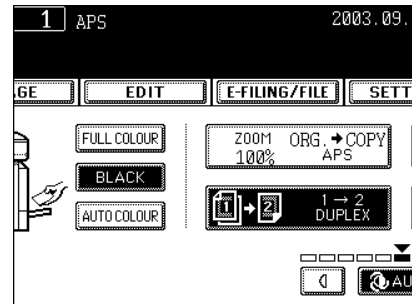

2. 1-Sided Originals -> 2-Sided Copies

The use of Image Direction will create the booklet output when copying landscape oriented originals. See "13.DIRECTION OF COPY IMAGES IN "1 TO 2" AND "2 TO 1"" Page 130 for details.

1 Place paper in the drawer(s).

- "1.SETTING COPY PAPER" Page 36
- When using this mode in bypass copying ("Bypass Copying" Page 59), be sure to specify the paper size.

2 Place the original(s).

- "2.SETTING ORIGINALS" Page 45

3 On the basic menu, press the highlighted button on the right.

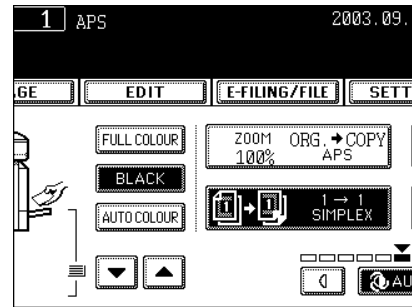

4 Press the [1 → 2 DUPLEX] button.

- Select other copy modes as required.

5 Press the [START] button.

- When placing an original on the glass, follow step 5 to 6 on page "Copying Procedure" Page 52 continuously.

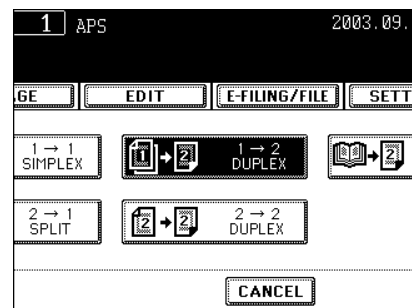

3. 2-Sided Originals -> 2-Sided Copies

1 Place paper in the drawer(s).

- "1.SETTING COPY PAPER" Page 36
- When using this mode in bypass copying ("Bypass Copying" Page 59), be sure to specify the paper size.

2 Place the original(s).

- "2.SETTING ORIGINALS" Page 45

3 On the basic menu, press the highlighted button on the right.

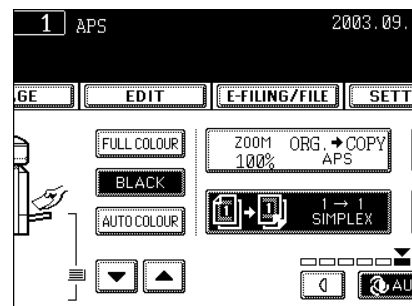

4 Press the [2 → 2 DUPLEX] button.

- Select other copy modes as required.

5 Press the [START] button.

- When placing an original on the glass, follow step 5 to 6 on page "Copying Procedure" Page 52 continuously.

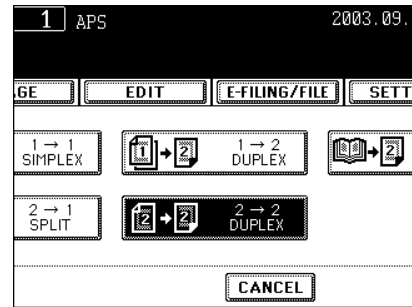

4. 2-Sided Originals -> 1-Sided Copies

Starting Image Direction can be used if the orientation of the output is alternating between pages when using landscape originals. See "13.DIRECTION OF COPY IMAGES IN "1 TO 2" AND "2 TO 1"" Page 130 for details.

1 Place paper in the drawer(s).

- "1.SETTING COPY PAPER" Page 36

2 Place the original(s).

- "2.SETTING ORIGINALS" Page 45

3 On the basic menu, press the highlighted button on the right.

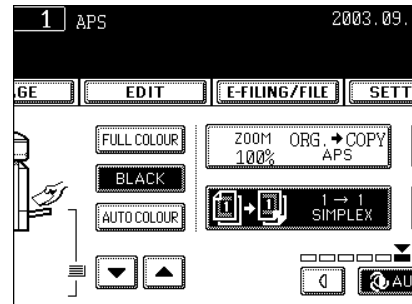

4 Press the [2 → 1 SPLIT] button.

- Select other copy modes as required.

5 Press the [START] button.

- When placing the original on the glass, copy the one side of the original and turn it over to copy the other side.

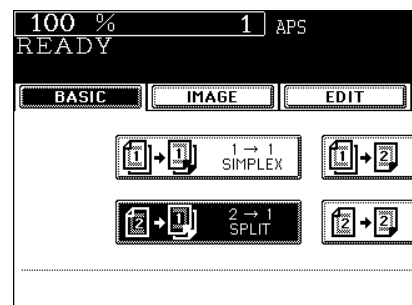

5. Book-type Originals -> 2-Sided Copies

* Acceptable paper size for this function are A4 or B5 only.

1 Place paper in the drawer(s).

- "1.SETTING COPY PAPER" Page 36
- When using this mode in bypass copying ("Bypass Copying" Page 59), be sure to specify the paper size.

2 On the basic menu, press the highlighted button on the right.

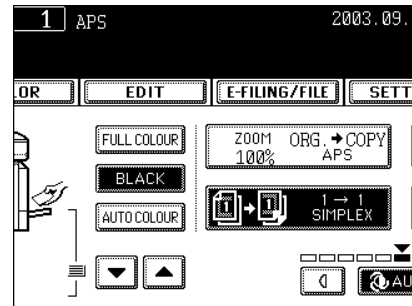

3 Press the [BOOK → 2] button.

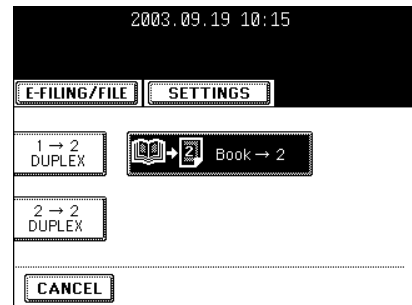

4 Select the book copying type.

- Press the [RIGHT → RIGHT] button if copying should start at a right-hand page and end at a right-hand page and also choose from among the [RIGHT → LEFT], [LEFT → LEFT] and [LEFT → RIGHT] buttons as well.

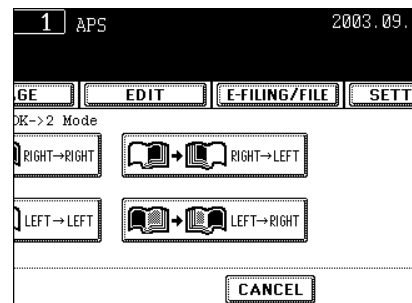

5 Select A4 or B5 copy size.

6 If you need a binding space, select the book margin mode from the Image Shift function ("Creating a Bookbinding Margin"  Page 107).

- Select other copy modes as required.

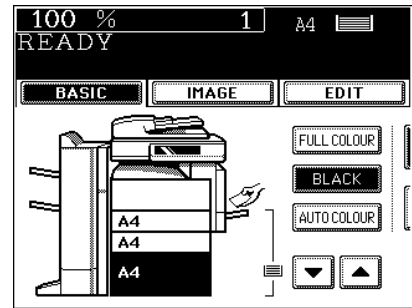

7 Place the first page(s) on the glass, and then press the [START] button.

- If you do not copy your originals from the first page, the copies will not be arranged in the same order as the original.
- Centre the book on the yellow indicator line with its bottom toward you. "Book-type Originals"  Page 48

8 Turn to the next page, set the book again and press the [START] button.

- Pressing the [YES] button and then the [START] button also continues copying.
- Repeat the procedure above until all the originals have been scanned.

9 After all the originals are scanned, press the [FINISHED] button.

- Press the [COPY FINAL PAGE] button if the last original has only one page.

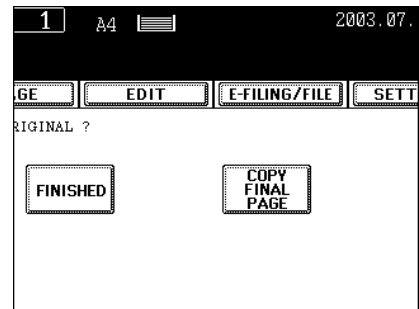
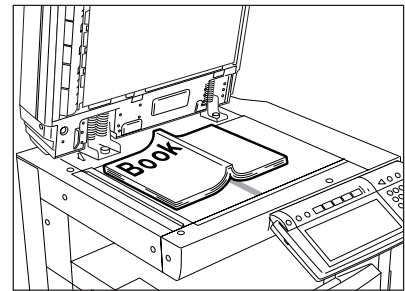

6. ORIGINAL MODE

By selecting an original mode according to the type of your originals, you can make copies with the suitable image.

* Be sure to select the original mode after having selected the black-and-white or colour mode.

1 Place paper in the drawer(s).

- "1.SETTING COPY PAPER" Page 36

2 Place the original(s).

- "2.SETTING ORIGINALS" Page 45

3 On the basic menu, press the highlighted button on the right.

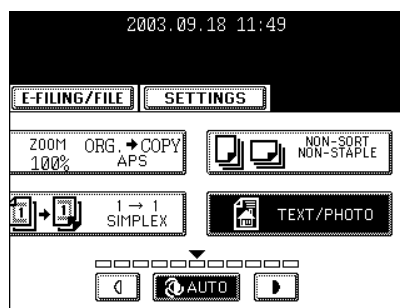

4 According to the type of your original, choose the most suitable image type mode by pressing one of the following buttons:

- [TEXT/PHOTO]: Original with text and printed image mixed (default setting)
- [TEXT]: Original with text only (or text and line artwork)
- [PRINTED IMAGE]: Original with printed photos using half tone dot patterns
- [PHOTO]: Original with photos printed on photographic paper It is used when the black mode is selected.
- [MAP]: Original with fine illustrations and text
- [IMAGE SMOOTHING]: Original with text and printed image mixed, which is available for the black mode It is used especially when you want to improve the photo reproducibility.



Selecting the image quality mode is limited depending on the setting of the black or colour mode on the basic screen.

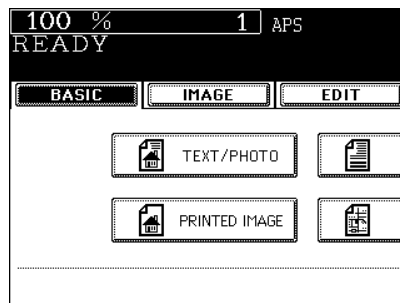

7. COPY DENSITY ADJUSTMENT

There are 2 types of image density adjustments: automatic mode and manual mode.

In the automatic mode, the density of each original is detected automatically and the optimum image density is selected. In the manual mode, you can select the desired level of image density. Adjust the density with this mode depending on the original condition.

* Default setting: Manual density for colour mode, Automatic density for black mode.

3

Automatic Copy Density Modes

1 Place paper in the drawer(s).

- "1.SETTING COPY PAPER" Page 36

2 Place the original(s).

- "2.SETTING ORIGINALS" Page 45

3 Press the [AUTO] button.

• Select other copy modes as required.

4 Press the [START] button.



Manual Copy Density Mode

1 Place paper in the drawer(s).

- "1.SETTING COPY PAPER" Page 36

2 Place the original(s).

- "2.SETTING ORIGINALS" Page 45

3 Press either the or button to adjust the copy density to the desired level.

- Each time you press either the or button, your copies will become lighter or darker respectively.

• Select other copy modes as required.

4 Press the [START] button.



4. IMAGE EDITING AND IMAGE ADJUSTMENT

1. COLOUR BALANCE (YMCK ADJUSTMENT)	96
2. RGB ADJUSTMENT	97
3. ONE-TOUCH ADJUSTMENT	98
4. BACKGROUND ADJUSTMENT	99
5. SHARPNESS ADJUSTMENT	100
6. TWIN (2-COLOUR) COPYING	101

1. COLOUR BALANCE (YMCK ADJUSTMENT)

This function allows you to adjust the colour balance by changing the toner amount of Yellow (Y), Magenta (M), Cyan (C) and Black (K).

* It is available only for the full colour mode.

1 Place paper in the drawer(s).

- "1.SETTING COPY PAPER" Page 36

2 Place the original(s).

- "2.SETTING ORIGINALS" Page 45

3 Press the [IMAGE] button to enter the image menu, and then press the [COLOUR BALANCE] button.

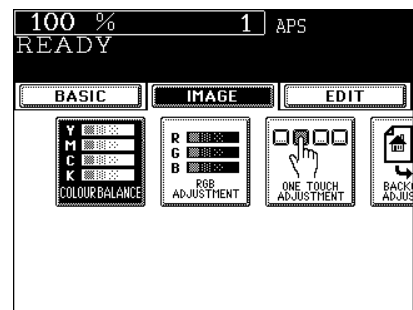

4 Press the or button to adjust the colour balance.

- Pressing the button enhances the tint of the colour, while pressing the button decreases the tint of the colour.

5 Press the [ENTER] button.

• Select other copy modes as required.

6 Press the [START] button.

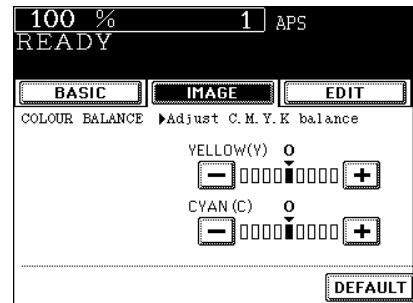

Tip

Canceling the colour Balance Adjustment
There are 2 ways for clearing the setting.

- Press the or button on the column you want to cancel to move the indicator to 0, then press the [ENTER] button.
- If you want to cancel all the 4 adjustments, press the [DEFAULT] button, and then press the [ENTER] button.

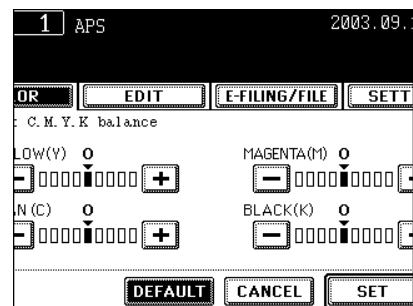

2. RGB ADJUSTMENT

This function allows you to adjust the colour balance by changing the strength of Red (R), Green (G) and Blue (B) at the time of scanning original.

It is available only in the full colour mode.

1 Place paper in the drawer(s).

- "1.SETTING COPY PAPER"  Page 36



2 Place the original(s).

- "2.SETTING ORIGINALS"  Page 45

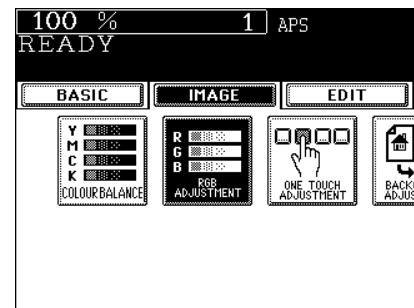
3 Press the [IMAGE] button to enter the image menu, and then press the [RGB ADJUSTMENT] button.



4 Press the or button to adjust the colour balance.

- Pressing the  button enhances the tint of the colour, while pressing the  button decreases the tint of the colour.

5 Press the [ENTER] button.

• Select other copy modes as required.

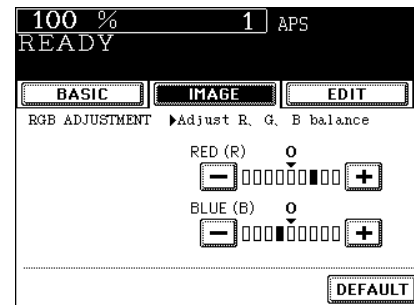

6 Press the [START] button.



Tip

Canceling the RGB Adjustment

There are 2 ways for clearing the setting.

- Press the  or  button on the column you want to cancel to move the indicator to 0, then press the [ENTER] button.
- If you want to cancel all the 3 adjustments, press the [DEFAULT] button, and then press the [ENTER] button.

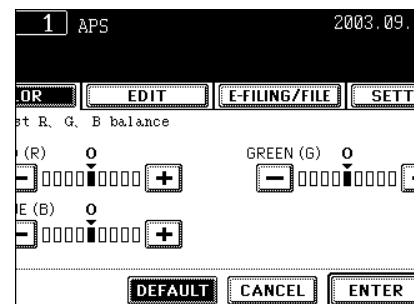

3. ONE-TOUCH ADJUSTMENT

You can make the image quality “warm”, “cool”, “vivid” or “clear” with just one touch. It is available only in the full colour mode.

1 Place paper in the drawer(s).

- "1.SETTING COPY PAPER"  Page 36

2 Place the original(s).

- "2.SETTING ORIGINALS"  Page 45

3 Press the [IMAGE] button to enter the image menu, and then press the [ONE TOUCH ADJUSTMENT] button.

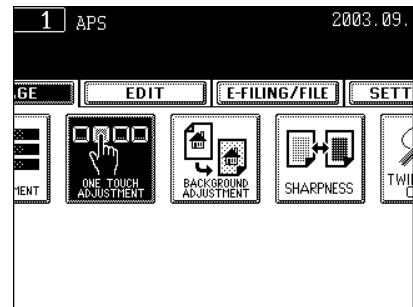

4 Press the [COOL] ([WARM], [VIVID], or [CLEAR]) button.

- Select other copy modes as required.

5 Press the [START] button.

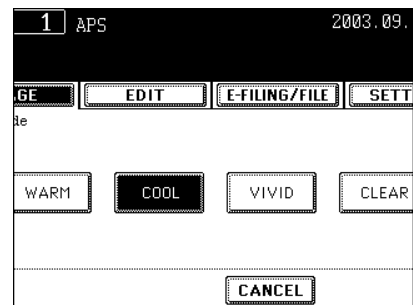

4. BACKGROUND ADJUSTMENT

This function allows you to adjust the density of the original's background or to avoid copying the back side of originals.

* It is available only in the full colour mode.

* Background Adjustment and Automatic Copy Density mode cannot be used together.

1 Place paper in the drawer(s).

- "1.SETTING COPY PAPER" Page 36

2 Place the original(s).

- "2.SETTING ORIGINALS" Page 45

3 Press the [IMAGE] button to enter the image menu, and then press the [BACKGROUND ADJUSTMENT] button.

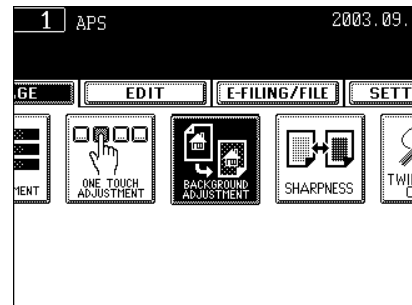

4 Press the [LIGHT] (or [DARK]) button to adjust the density.

5 Press the [ENTER] button.

- Select other copy modes as required.

6 Press the [START] button.

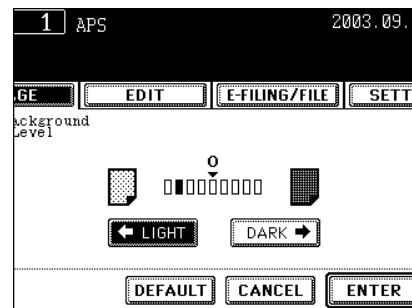

Tip

Canceling the Background Adjustment

There are 2 ways for clearing the setting.

- Press the [LIGHT] or [DARK] button on the Background column to move the indicator to 0, and then press the [ENTER] button.
- Press the [DEFAULT] button, and then press the [ENTER] button.

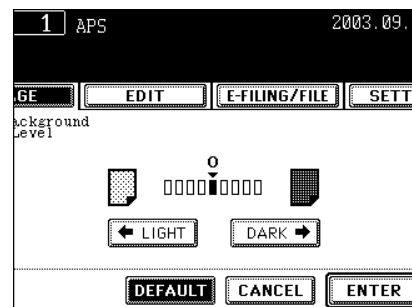

5. SHARPNESS ADJUSTMENT

This function allows you to emphasize the letters and edges of images. This function is available in the black-and-white mode as well.

1 Place paper in the drawer(s).

- "1.SETTING COPY PAPER" Page 36

2 Place the original(s).

- "2.SETTING ORIGINALS" Page 45

3 Press the [IMAGE] button to enter the image menu, and then press the [SHARPNESS] button.

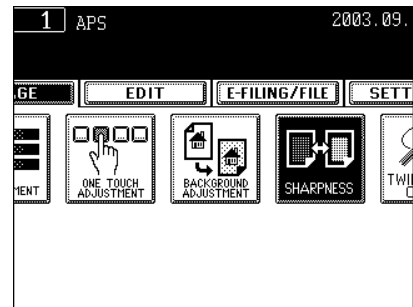

4 Press the [SOFT] (or [SHARP]) button.

- Pressing the [SOFT] button suppresses the moire fringe, while pressing the [SHARP] button emphasizes the letters and sharpens the fine lines.

5 Press the [ENTER] button.

• Select other copy modes as required.

6 Press the [START] button.

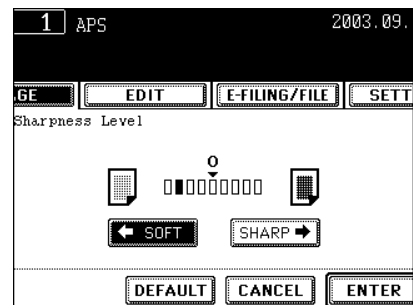

Tip

Canceling the Sharpness Adjustment

There are 2 ways for clearing the setting.

- Press the [SOFT] or [SHARP] button on the Sharpness column to move the indicator to 0, and then press the [ENTER] button.
- Press the [DEFAULT] button, and then press the [ENTER] button.

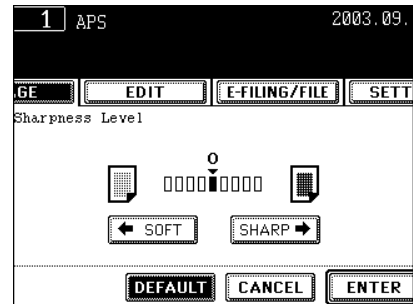

6. TWIN (2-COLOUR) COPYING

You can make a copy with 2 colours from a coloured original. There are 2 ways of doing this:

- Making 2-colour copies with 2 manually-selected colours:
The coloured original can be copied in selected colour for the black part and in another selected colour for the other part.
- Making 2-colour copies using red and black:
The coloured original can be copied in red for the red part and in black for the other part.

Twin (2-colour) Copy with Selected Colours

1 Place paper in the drawer(s).

- "1.SETTING COPY PAPER"  Page 36

2 Place the original(s).

- "2.SETTING ORIGINALS"  Page 45

3 Press the [IMAGE] button to enter the image menu, and then press the [TWIN COLOUR COPY] button.

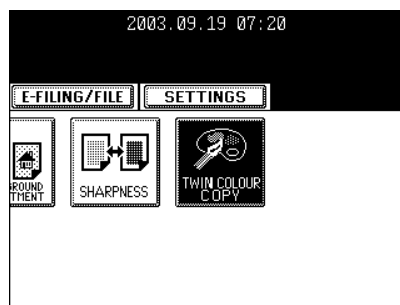

4 Press the [TWIN COLOUR SELECTABLE] button.

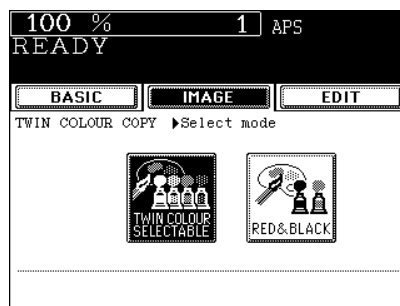

5 Select a colour for the black areas on the original.

- After pressing the [CHANGE BLACK TO] button, select the desired colour.

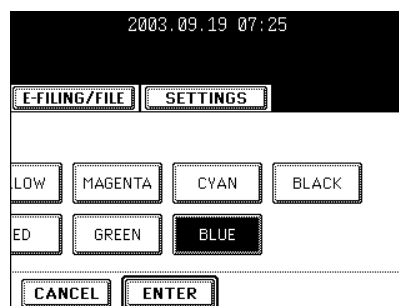
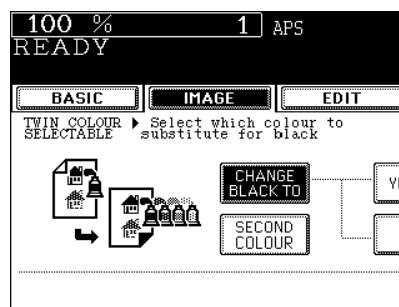

6 Select a colour for the parts other than black on the original.

- After pressing the [SECOND COLOUR] button, select the desired colour.

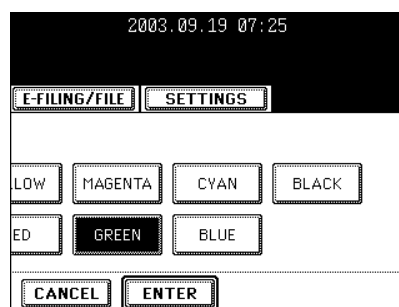
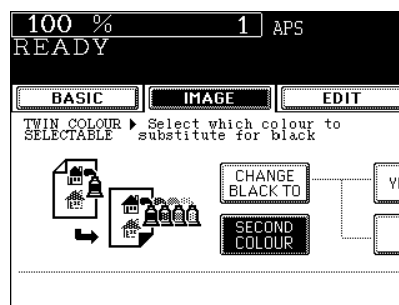

7 After selecting [CHANGE BLACK TO] and [SECOND COLOUR], press the [ENTER] button.

- Select other copy mode as required.

8 Press the [START] button.

Twin (2-Colour) Copying with Red and Black

1 Place paper in the drawer(s).

- "1.SETTING COPY PAPER"  Page 36

2 Place the original(s).

- "2.SETTING ORIGINALS"  Page 45

3 Press the [IMAGE] button to enter the image menu, and then press the [TWIN COLOUR COPY] button.

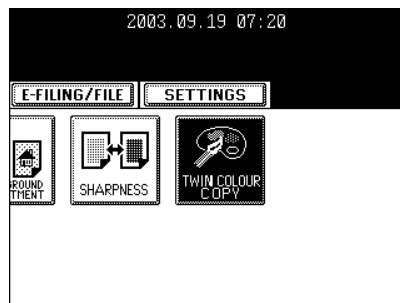

4 Press the [RED & BLACK] button.

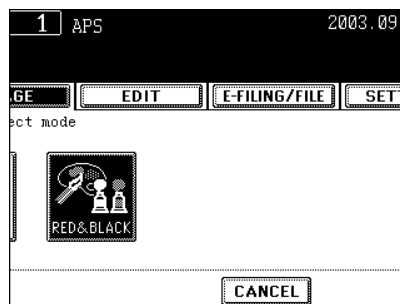

5 Press the [ENTER] button.

- Select other copy modes as required.

6 Press the [START] button.

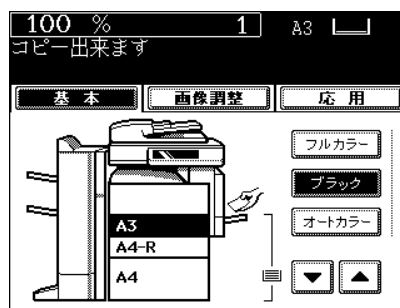



5. USING THE EDITING FUNCTIONS

1. IMAGE SHIFT	106
2. EDGE ERASE.....	109
3. BOOK CENTRE ERASE.....	110
4. DUAL-PAGE.....	111
5. 2 IN 1/4 IN 1	113
6. MAGAZINE SORT (FROM THE EDITING MENU)	116
7. IMAGE EDITING	118
Trimming/Masking.....	118
Mirror Image.....	120
8. X-Y ZOOM	121
9. COVER COPYING.....	122
10.SHEET INSERTION MODE.....	125
11.TIME & DATE STAMP	127
12.PAGE NUMBERING	128
13.DIRECTION OF COPY IMAGES IN “1 TO 2” AND “2 TO 1”	130
14.DIRECTION OF DUPLEX COPY IMAGES IN “2 TO 2”	132
15.CONTINUOUS/SINGLE ORIGINAL FEEDING.....	133

1. IMAGE SHIFT

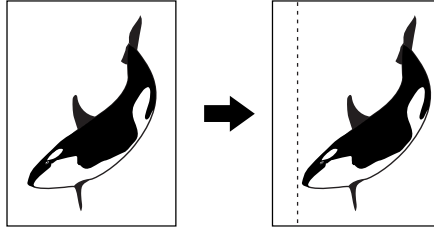

A margin for binding is created by shifting the original image to either the right or left side. You can also create binding margins in the centre (inner margin) when using Book-Type Originals to 2-sided copies (see "5. Book-type Originals -> 2-Sided Copies"  Page 91).



5

Creating a Right or Left Margin

1 Place paper in the drawer(s).

- "1.SETTING COPY PAPER"  Page 36
- When using this mode in bypass copying ("Bypass Copying"  Page 59), be sure to specify the paper size.

2 Place the original(s).

- "2.SETTING ORIGINALS"  Page 45

3 Press the [EDIT] button to enter the edit menu, and then press the [IMAGE SHIFT] button.

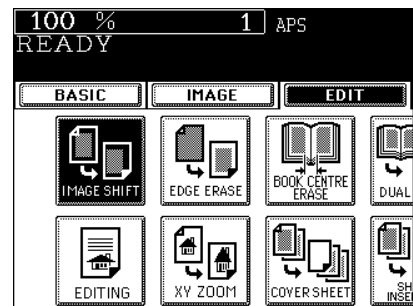

4 Press the [LEFT] (or [RIGHT]) button according to your desired binding side.

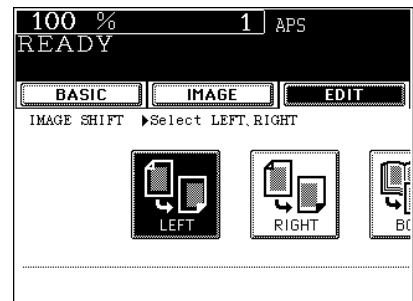

5 Adjust the width of binding margin, and then press the [ENTER] button.

- The default width of the margin is 7 mm.
- To adjust the width, press the [0mm] or [30mm] button to select the desired number, and then press the [ENTER] button.
- In duplex copying, margins on the back are created on the other side of those in the front.

"5.DUPLEX COPYING" Page 87

- Select other copy modes as required.

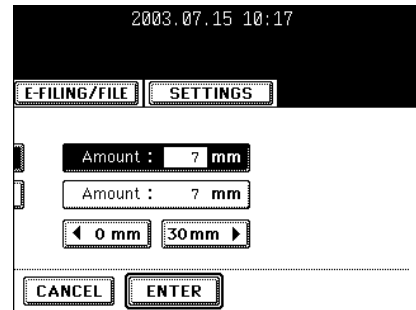

6 Press the [START] button.

Creating a Bookbinding Margin

When Book Margin is selected, use it in conjunction with the Duplex Copying mode from book-type originals ("5. Book-type Originals -> 2-Sided Copies" Page 91) or the Dual-Page mode (2-sided) ("4.DUAL-PAGE" Page 111).

Acceptable paper sizes for this function are A4, B5 and LT only.

1 Press the [EDIT] button to enter the edit menu, and then press the [IMAGE SHIFT] button.

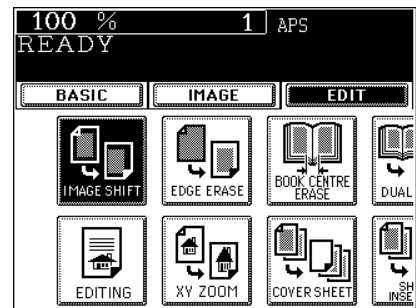

2 Press the [BOOK] button.

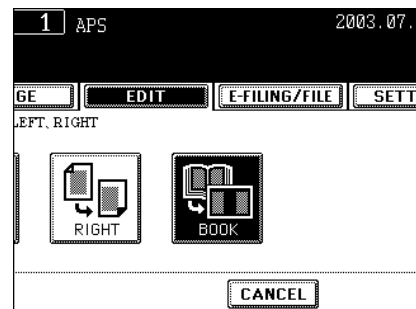

3 Adjust the width of the margin, and then press the [ENTER] button.

- The default width of the margin is 7 mm (Book binding margin is 14 mm.).
- To adjust the width, press the [2 mm] or [30 mm] button to select the desired number, and then press the [ENTER] button.

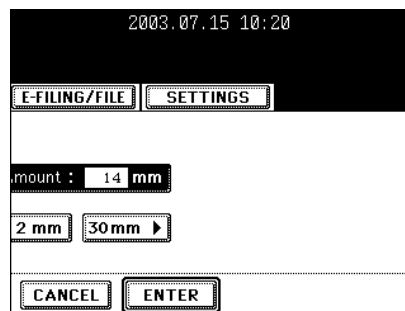

2. EDGE ERASE

If your original has a dirty or torn edge, it may be reproduced as a black stain on the copy. In that case, use Edge Erase Copying. A white border is created along the edges of the copy, eliminating those black stains.

* This function is available in only case of the standard-size original.

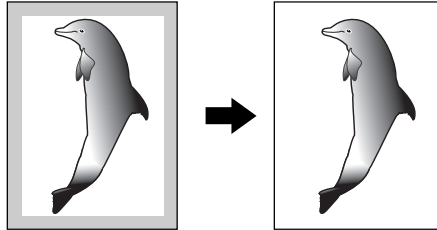

5

1 Place paper in the drawer(s).

- "1.SETTING COPY PAPER" Page 36
- When using this mode in bypass copying ("Bypass Copying" Page 59), be sure to specify the paper size.

2 Place the original(s).

- "2.SETTING ORIGINALS" Page 45

3 Press the [EDIT] button to enter the edit menu, and then press the [EDGE ERASE] button.

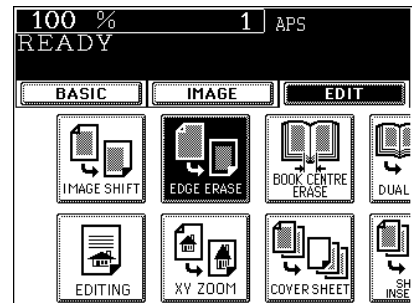

4 Adjust the width of the white border, and then press the [ENTER] button.

- The default width of the white border is 5 mm.
- To adjust the width, press the [5 mm] or [20 mm] button to select the desired number, and then press the [ENTER] button.

- Select other copy modes as required.

5 Press the [START] button.

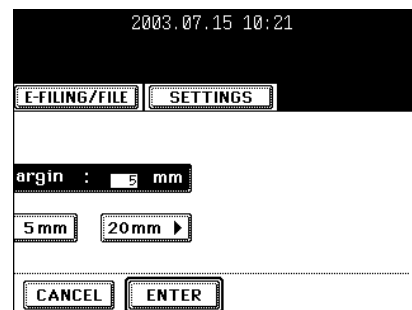

3. BOOK CENTRE ERASE

This feature allows you to erase the shadow in the centre of a book original.

- 1: Before
- 2: After the book centre has been erased

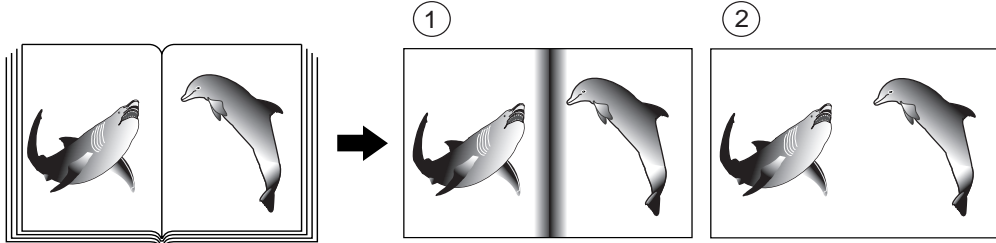

5

1 Place paper in the drawer(s).

- "1.SETTING COPY PAPER" Page 36
- When using this mode in bypass copying ("Bypass Copying" Page 59), be sure to specify the paper size.

2 Place the original(s).

- "2.SETTING ORIGINALS" Page 45

3 Press the [EDIT] button to enter the edit menu, and then press the [BOOK CENTRE ERASE] button.

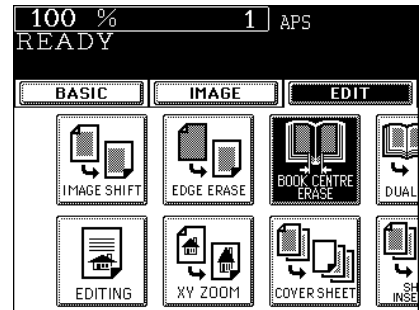

4 Adjust the width of the book centre erase margin, and then press the [ENTER] button.

- The default width of the book centre erase margin is 10 mm.
- To adjust the width, press the [2 mm] or [50 mm] button to select the desired number, and then press the [ENTER] button.
- Select other copy modes as required.

5 Press the [START] button.

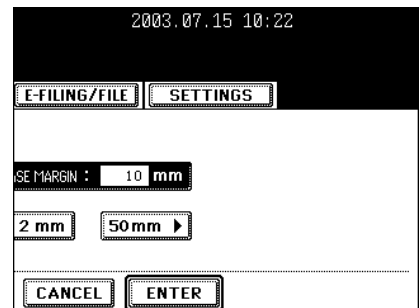

4. DUAL-PAGE

Utilizing this feature allows the facing pages of a book or magazine to be copied page by page onto 2 separate sheets of paper or duplex-copied on one sheet. There is no need to move the original on the glass. You can also place a pair of A4 (or B5, LT) sized originals side by side and copy them on separate sheets of paper.

* Acceptable paper sizes for this function are A4, B5 and LT only.

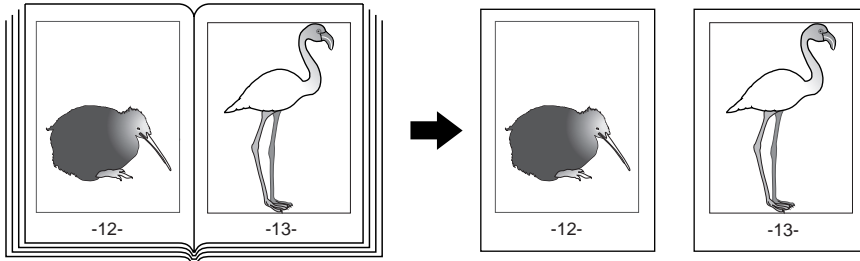

5

1 Place paper in the drawer(s).

- "1.SETTING COPY PAPER" Page 36
- When using this mode in bypass copying ("Bypass Copying" Page 59), be sure to specify the paper size.

2 Press the [EDIT] button to enter the edit menu, and then press the [DUAL PAGE] button.

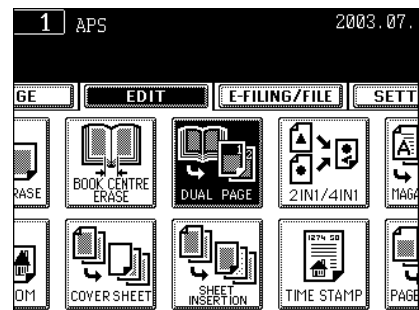

3 Press the [1 SIDE] (or [2 SIDE]) button.

- Select the [1 SIDE] button to make copies of the facing pages on 2 separate sheets of paper page by page. Select the [2 SIDE] button to make duplex copies of them on one sheet.

4 If you need a binding margin, set the bookbinding margin.

- "Creating a Bookbinding Margin" Page 107

5 Press the [BASIC] button to enter the basic menu, and then select A4 (or B5, LT) copy size.

- Select other copy modes as required.

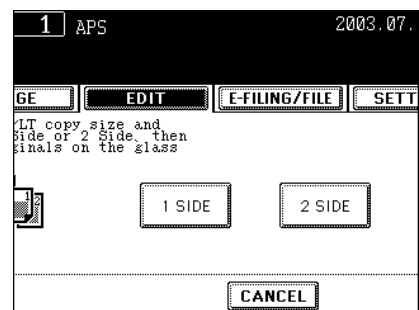

6 Place the first page(s) to be copied on the glass, and then press the [START] button.

- If you do not copy your originals from the first page, the copies will not be arranged in the same order as the original.
- Centre the book on the yellow indicator line with the bottom toward you. "Book-type Originals"  Page 48

7 Turn to the next page, set the book again, and then press the [START] button.

- Repeat the above procedure until all the originals have been scanned.

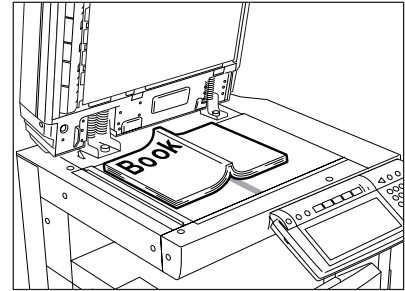

8 After all the originals have been scanned, press the [FINISHED] button.

- Press the [COPY FINAL PAGE] button if the last original is 1-sided page.

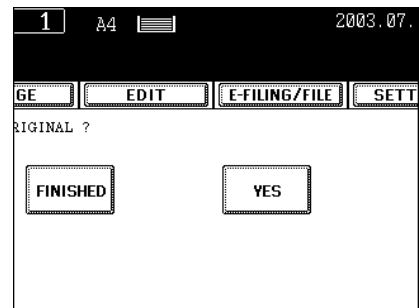

5. 2 IN 1/4 IN 1

This feature allows multiple originals to be reduced and copied onto a single sheet of paper. There are 2 modes: 2 IN 1 copying, where 2 originals are copied onto a single sheet, and 4 IN 1 copying, where 4 originals are copied onto a single sheet. In addition, duplex 2 IN 1/4 IN 1 modes are available, where four/eight originals can be copied to 2 sides of a single sheet of paper.

* This mode cannot be used in combination with reduction/enlargement copying.

- 2 IN 1

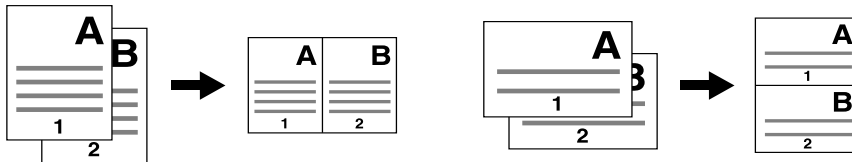

- 4 IN 1

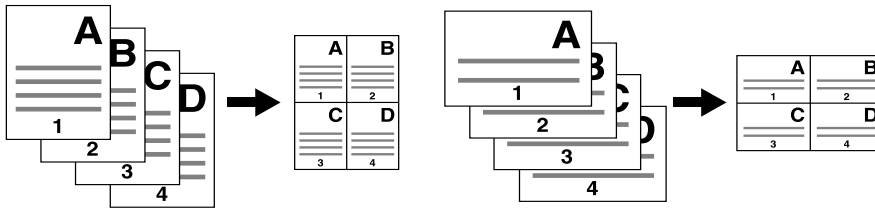

- 2 IN 1 DUPLEX (a: Side 1, b: Side 2)

* When a copy is turned with the line as a pivot, originals are printed on Side 2 (back face) as shown.

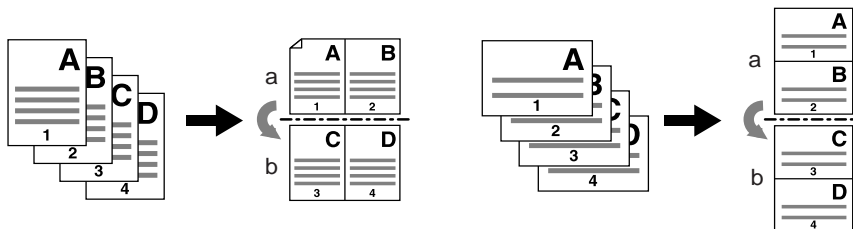

- 4 IN 1 DUPLEX (a: Side 1, b: Side 2)

* When a copy is turned with the line as a pivot, originals are printed on Side 2 (back face) as shown.

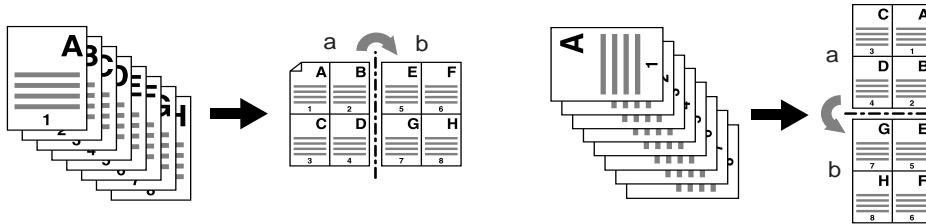

5

1 Place paper in the drawer(s).

- "1.SETTING COPY PAPER" Page 36
- When using this mode in bypass copying ("Bypass Copying" Page 59), be sure to specify the paper size.

Tip

To make copies onto paper which is not the same size as originals, press the [ZOOM...] button to display the screen on the right, and then press the desired paper size and the [AMS] button.

2 Place the original(s).

- "2.SETTING ORIGINALS" Page 45

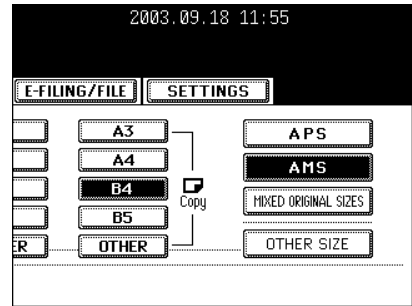

3 Press the [EDIT] button to enter the edit menu, and then press the [2 IN 1/4 IN 1] button.

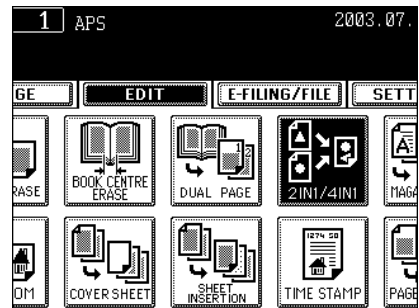

4 Select the type of image combination.

- Press the [2 IN 1] (or [4 IN 1], [2 IN 1 DUPLEX] or [4 IN 1 DUPLEX]) button.

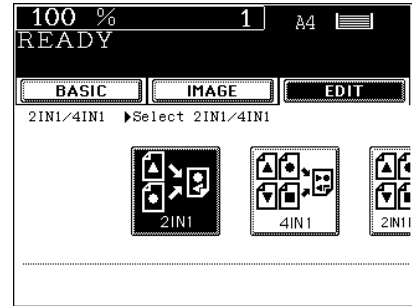

5 Select the type of the original.

- Press the [1 SIDE] (or [2 SIDE]) button.
- Select other copy modes as required.

6 Press the [START] button.

- When placing an original on the glass, follow the steps 5 to 6 on "Copying Procedure"  Page 52 continuously.

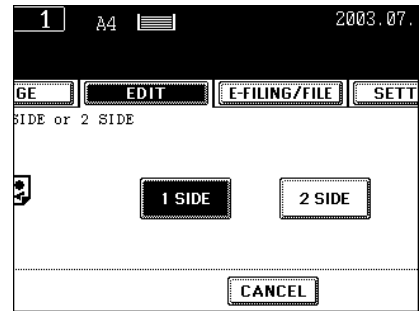

6. MAGAZINE SORT (FROM THE EDITING MENU)

The magazine sort mode allows 1-sided originals to be copied and sorted so that they can be folded and bound along a centre line like typical magazines or booklets.

Example of copying a 12-page document

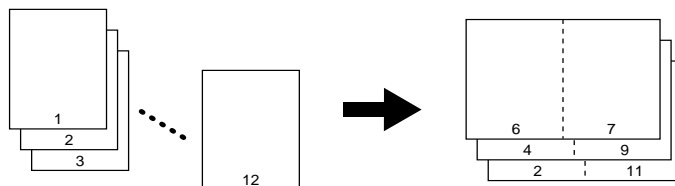

- If used in combination with the optional finisher (MJ-1024) equipped with saddle stitch, copies can be automatically folded in half and stapled along their centre line. (A3, A4-R, B4, LD and LT-R are available.)

5

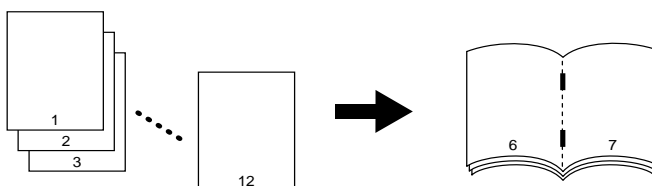

- * 2 Magazine Sort procedures are available. For this function operated from the BASIC menu when the finisher (optional) is installed. See "Magazine Sort & Saddle Stitch Mode (Booklet Mode)" Page 82
- * When placing the portrait original in short edge feed direction in the reversing automatic document feeder, copies can be made correctly with Image Direction setting. See "13.DIRECTION OF COPY IMAGES IN "1 TO 2" AND "2 TO 1"" Page 130.

1 Place paper in the drawer(s).

- "1.SETTING COPY PAPER" Page 36

2 Select the paper type.

- For drawer feeding "Manual Paper Selection" Page 68, step 3
- For bypass feeding "Bypass Copying on Standard Size of Paper" Page 59, step 4

3 Place the original(s).

- "2.SETTING ORIGINALS" Page 45
- When placing them in the reversing automatic document feeder (optional), set them by referring to the order of pages in the illustrations above.
- When placing them on the glass, place the first page of the originals first.

4 Press the [EDIT] button to enter the edit menu, and then press the [MAGAZINE SORT] button.

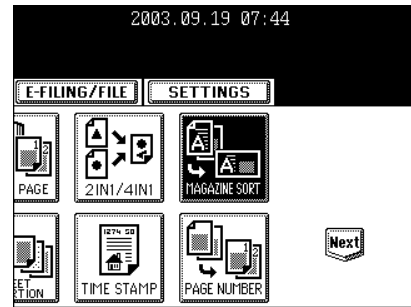

5 Adjust the binding margin, and then press the [ENTER] button.

- The default width of the margin is 2 mm.
- To adjust the width, press the [2 mm] or [30 mm] button to select the desired number, and then press the [ENTER] button.
- If the optional finisher (MJ-1024) equipped with the saddle stitch is installed, copied paper can be automatically stapled along their centre line. Press the [STAPLE ON] button to staple it.
- Maximum number of sheets that can be stapled. "Available Conditions for Saddle Stitch" Page 84

- Select other copy modes as required.

6 Press the [START] button.

- When placing an original on the glass, follow steps 5 to 6 on "Copying Procedure" Page 52 continuously.

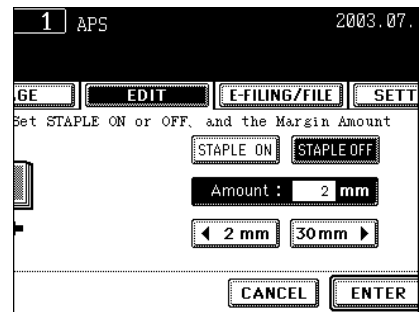

7. IMAGE EDITING

Trimming/Masking

You can select an area on an original and copy it with the area trimmed (only the inside of the area copied) or masked (only the outside of the area copied). 4 rectangular areas can be specified on an original.

- * Image editing is only available with standard sized originals.
- * If the settings of the original and copy sizes are not made appropriately, the image may not be copied completely.
 - 1: Trimming
 - 2: Masking

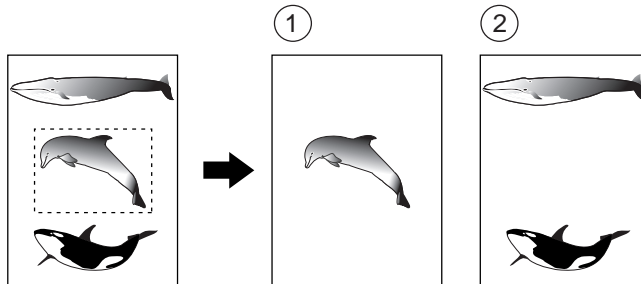

1 Place paper in the drawer(s).

- "1.SETTING COPY PAPER" Page 36
- When using this mode in bypass copying ("Bypass Copying" Page 59), be sure to specify the paper size.

2 Press the [EDIT] button to enter the edit menu, and then press the [EDITING] button.

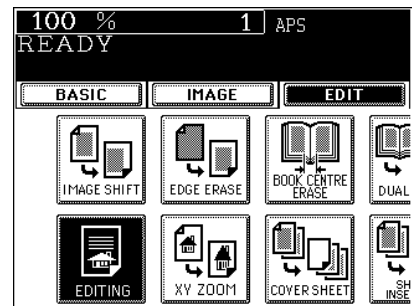

3 Press the [TRIM] (or [MASK]) button.

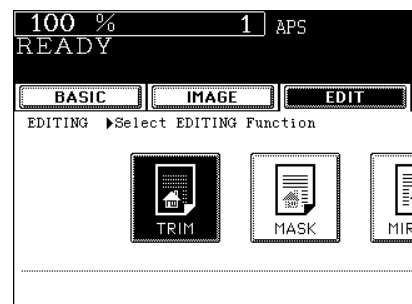

4 Place an original on the glass to specify the area.

- Set the original face up with the bottom toward you, fit its top left corner against the top left corner of the glass, and align it with the original scale.

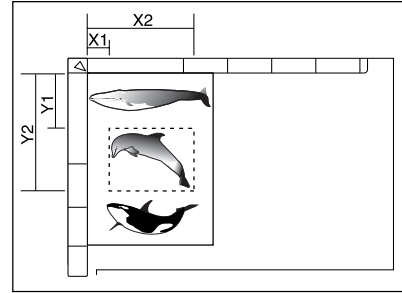

5 Using the original scale on the left and the inner (top) scale, read the position of the desired area as follows:

- X1 Distance from the top left to the left edge of the specified area.
- X2 Distance from the top left to the right edge of the specified area.
- Y1 Distance from the top left to the upper edge of the specified area.
- Y2 Distance from the top left to the lower edge of the specified area.

Tip

4 rectangular areas can be specified on an original.

6 Enter the distance values read in step 5 for the specified area.

- Key in the value for X1 with the digital keys and press the [SET] button.
- Similarly, set the values for X2, Y1 and Y2.
- When setting X1, X2, Y1 and Y2, the original scale automatically changes to the next original scale. Set the next original scale similarly.

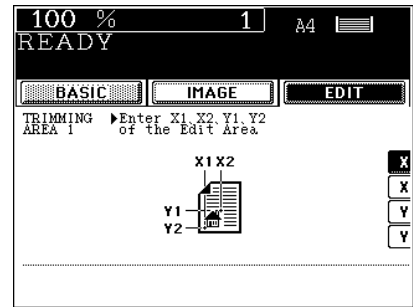

7 Press the [ENTER] button.

8 Place the original(s).

- "2.SETTING ORIGINALS" Page 45
- Place the original(s) on the glass with its face down, with its bottom toward you, with its top left aligned against the original scale on the left side.

- Select other copy modes as required.

9 Press the [START] button.

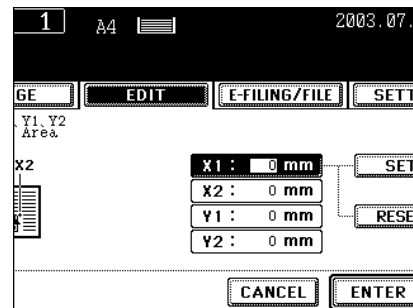

Mirror Image

Copies are made with images completely reversed (right and left).

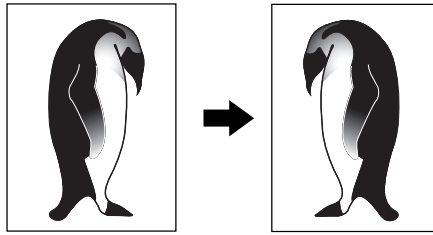

5

1 Place paper in the drawer(s).

- "1.SETTING COPY PAPER" Page 36
- When using this mode in bypass copying ("Bypass Copying" Page 59), be sure to specify the paper size.

2 Place the original(s).

- "2.SETTING ORIGINALS" Page 45

3 Press the [EDIT] button to enter the edit menu, and then press the [EDITING] button.

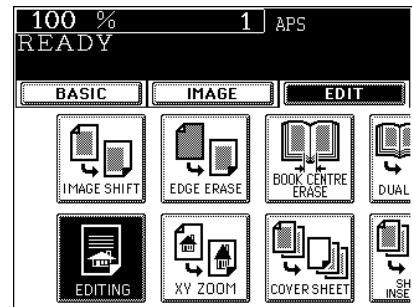

4 Press the [MIRROR] button.

- Select other copy modes as required.

5 Press the [START] button.

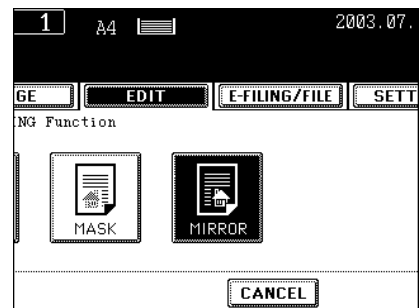

8. X-Y ZOOM

You can make copies with different reproduction ratios set for the X (horizontal) and Y (Vertical) directions in the range of 25 to 400% respectively.

In the following cases, set the reproduction ratio in the range of 25 to 200%.

- When setting the “full colour”, “auto colour”, “twin colour” or “image smoothing” mode.
- When placing the original(s) on the reversing automatic document feeder (optional).

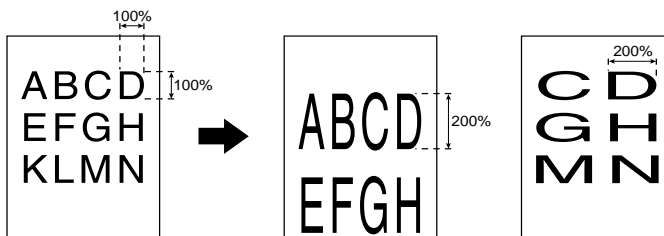

5

1 Place paper in the drawer(s).

- "1.SETTING COPY PAPER" Page 36

2 Place the original(s).

- "2.SETTING ORIGINALS" Page 45

3 Press the [EDIT] button to enter the edit menu, and then press the [XY ZOOM] button.

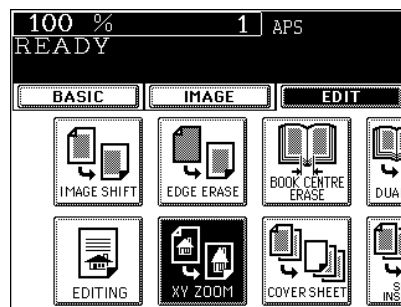

4 Set the reproduction ratios for the X (horizontal) and Y (Vertical) directions respectively.

- Using the [25%] and [400%] buttons on the screen, set the reproduction ratio for X and press the [SET] button. Similarly, set the reproduction ratio for Y.

5 Press the [ENTER] button.

- Select other copy modes as required.

6 Press the [START] button.

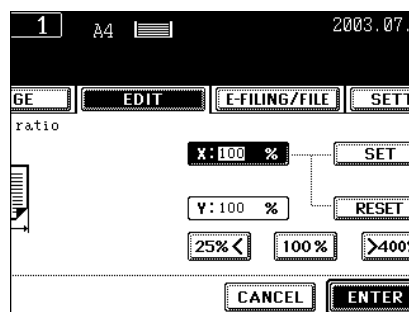

9. COVER COPYING

A top cover and /or back cover (special sheets, e.g. coloured paper) can be added to each set of copies. It is available only when the reversing automatic document feeder (optional) is in use.

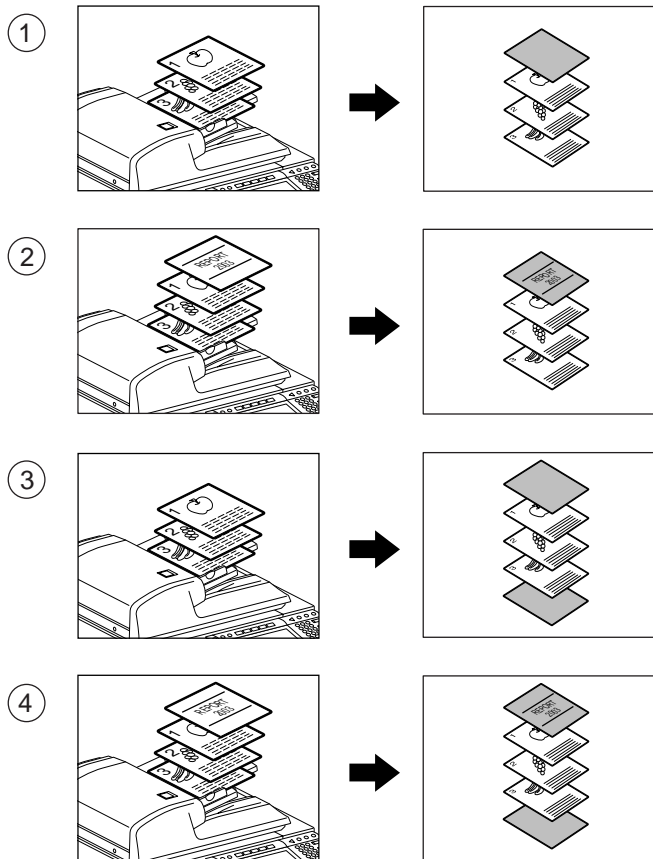

- 1: Adding a blank cover
- 2: Adding a copied cover
- 3: Adding a blank cover and a blank back cover
- 4: Adding a copied cover and blank back cover



Tip

When using the cover feature, make sure all paper sources have the same orientation and size. The cover sheets are placed in the drawer for cover sheet or on the bypass tray.

1 Place the cover sheet in the drawer for cover sheet or on the bypass tray.

- When placing it in the drawer for the cover sheet, it is necessary to set the paper type (cover sheet), size and weight. Setting the drawer for special use. "Setting the Drawer for Special Uses"  Page 41
- When placing it on the bypass tray, it is necessary to set the paper size and weight. "Bypass Copying on Standard Size of Paper"  Page 59

2 Place paper (other than cover paper) in the drawer(s).

- "Setting the Drawer for Special Uses"  Page 41
- Place the paper of the same size and the same direction as that of cover.

3 Place the original(s).

- "2.SETTING ORIGINALS"  Page 45
- When placing an original on the glass, place the first page of your originals first.

4 Press the [EDIT] button to enter the edit menu, and then press the [COVER SHEET] button.

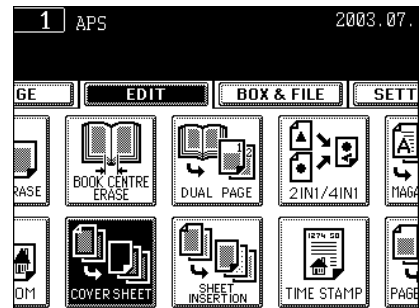

5 Select the desired cover sheet button:

- To add a blank top cover: [TOP BLANK]
- To add a copied top cover: [TOP COPIED]
- To add blank top and back covers: [BOTH BLANK]
- To add copied top and blank back covers: [TOP COPIED BACK BLANK]

6 Press the [BASIC] button to enter the basic menu, and then select the paper source of the same size and direction as the cover sheet paper.

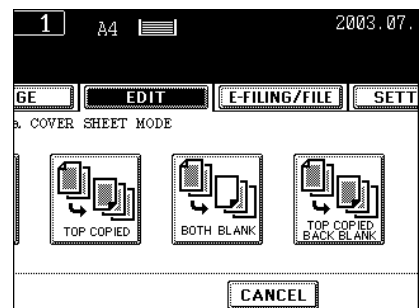

- Setting the drawer for cover sheet. "Changing the Paper Size of the Drawer/Setting the Drawer for Special Uses"  Page 38

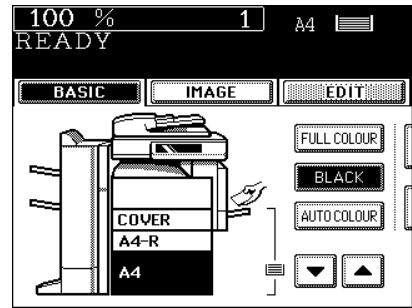

- Setting the bypass tray. "Bypass Copying"  Page 59
- Select other copy modes as required.

7 Press the [START] button.

Tip

When [TOP COPIED] button or [TOP COPIED BACK BLANK] button is selected, the cover sheet can be copied only on the top face (single-side) though 1-Sided Original to 2-Sided Copy is used.

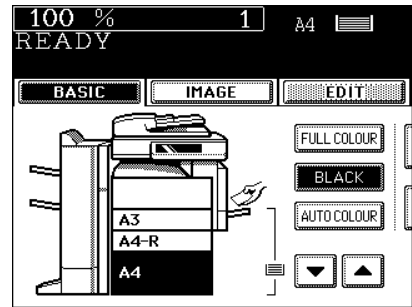

10. SHEET INSERTION MODE

Special sheets of paper (such as coloured paper) are inserted into a set of copies at the specified pages. There are 2 types of sheet insertion modes:

- 1 : Inserting blank sheets before the specified pages
- 2 : Inserting copied sheets at the specified pages

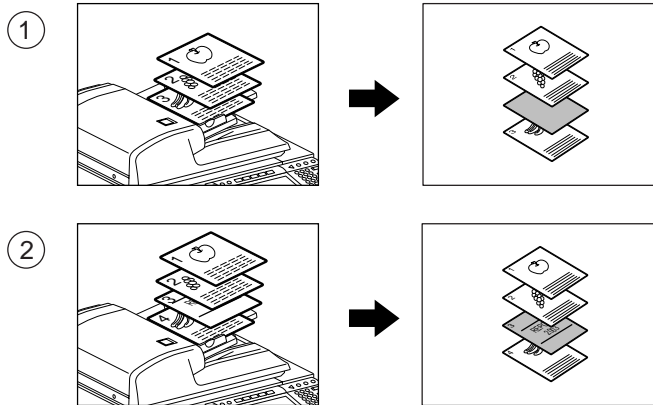

Tip

To make sheet copies, you have to set 2 drawers (or use the large capacity feeder and set one drawer in the same paper size and orientation (one for special insertion sheets and the other for normal sheets of copy paper)).

1 Place sheets of paper in the drawer for the sheet insertion.

- "Changing the Paper Size of the Drawer/Setting the Drawer for Special Uses" Page 38

2 Place plain paper in the drawer(s). (The same size and direction in step 1)

3 Place the original(s).

- "2.SETTING ORIGINALS" Page 45

4 Press the [EDIT] button to enter the edit menu, and then press the [SHEET INSERTION] button.

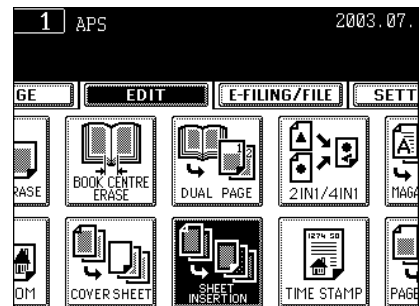

5 Press [COPIED] or [BLANK] button.

- To insert copied sheet at the specified page: [COPIED]
- To insert blank sheet before the specified paper: [BLANK]

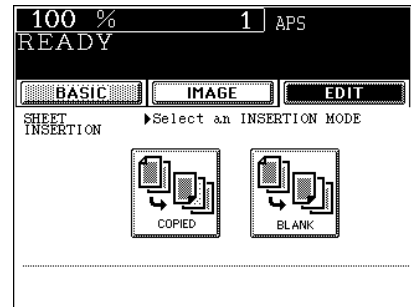

6 Key in the desired page number (no more than 3 digits) for insertion and press the [SET] button.

- On the screen, the page where the first sheet will be inserted is shown. The example on the right shows the first sheet inserted at (or before) page 10.
- To specify the next and subsequent pages, repeat step 6. Up to 15 pages can be specified.
- To have different sheets inserted than Insert source 1, select [INSERT SOURCE 2] and similarly key in the pages where you want the sheets inserted, then press the [SET] button. In this case, up to 15 pages in all can be specified for the source 1 and 2.

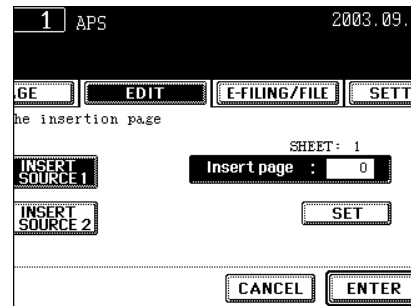

7 After you have finished specifying the insertion pages, press the lower [ENTER] button.

8 Key in the number of sets (or copies).

- Select other copy modes as required.

9 Press the [START] button.

11. TIME & DATE STAMP

The time and date of the scanning can be added to the copies.

- 1: Printed at the bottom of the portrait copy
- 2: Printed at the top of the landscape copy

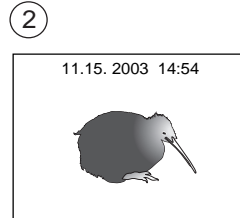
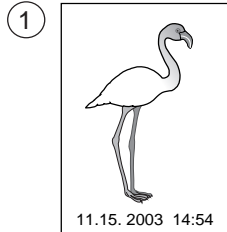

5

1 Place paper in the drawer(s).

- "1.SETTING COPY PAPER"  Page 36

2 Place the original(s).

- "2.SETTING ORIGINALS"  Page 45

3 Press the [EDIT] button to enter the edit menu, and then press the [TIME STAMP] button.

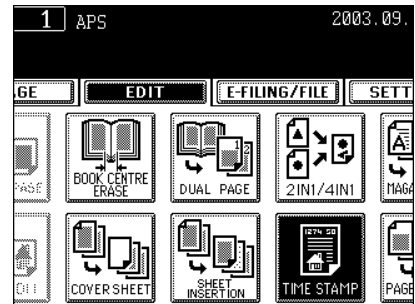

4 Select the orientation ([Short edge] or [Long edge]) and position (UPPER or LOWER) of the date and time to be printed, and then press the [ENTER] button.

- Select other copy modes as required.

5 Press the [START] button.

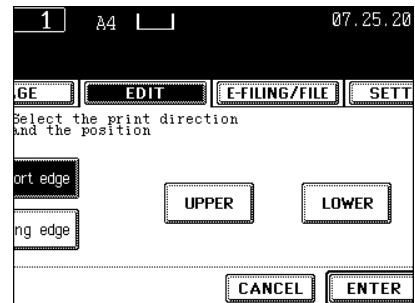

12. PAGE NUMBERING

This feature allows numbers to be added at specified positions on copies.

- 1: Page number printed at the bottom centre on the portrait copy.
- 2: Page number printed at the top right on the landscape copy.

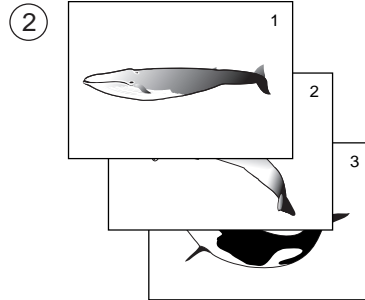
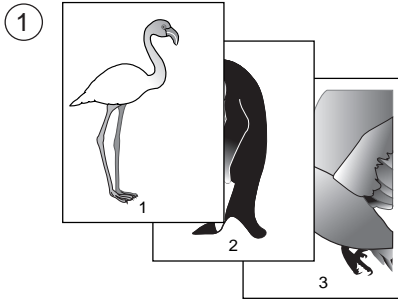

5

1 Place paper in the drawer(s).

- "1.SETTING COPY PAPER" Page 36

2 Place the original(s).

- "2.SETTING ORIGINALS" Page 45

3 Press the [EDIT] button to enter the edit menu, and then press the [PAGE NUMBER] button.

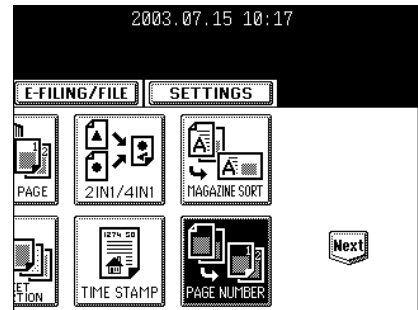

4 Select the orientation ([Short edge] or [Long edge]) and position of the page number to be printed, and then press the [ENTER] button.

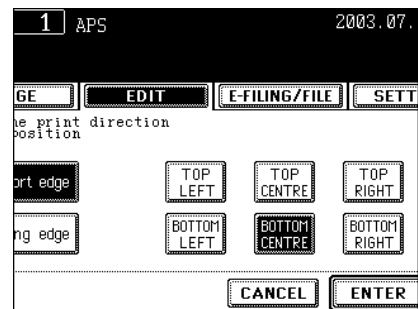

5 Key in the starting page number.

- If the start page number is "1", just press the [ENTER] button.

- Select other copy modes as required.

6 Press the [START] button.

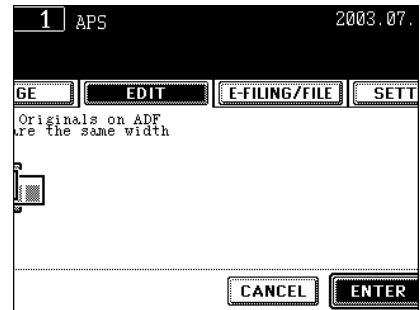

13. DIRECTION OF COPY IMAGES IN "1 TO 2" AND "2 TO 1"

When a lengthwise A3, A5 or B4 original is copied under the mode of 1-Sided Originals to 2-Sided Copies, 2-Sided Originals to 1-Sided Copies, this function allows you to adjust the direction for 'open to left' opening.

* This function is not necessary for copying in the direction of 'vertical' opening.

- 1: Set
- 2: Non set

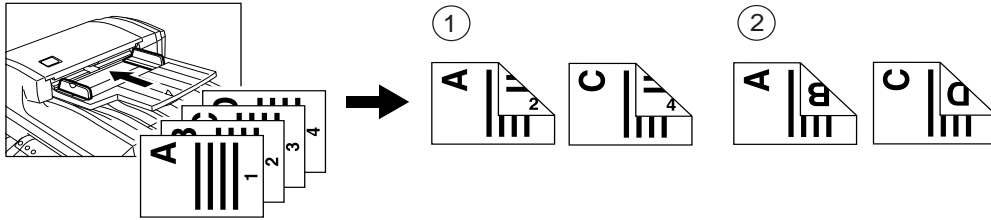

5

1 Place paper in the drawer(s).

- "1.SETTING COPY PAPER" Page 36

2 Place the original(s).

- "2.SETTING ORIGINALS" Page 45

3 Select 1-Sided Originals to 2-Sided Copies (or 2-Sided Originals to 1-Sided Copies).

- "5.DUPLEX COPYING" Page 87

4 Press the [EDIT] button to enter the edit menu, and then press the [IMAGE DIRECTION] button.

- If the desired function buttons are not displayed, press the [Next] button to change the menu.

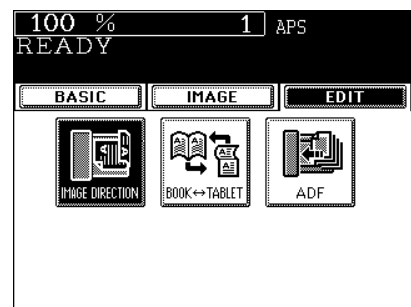

5 Press the [ENTER] button.

- Select other copy modes as required

6 Press the [START] button.

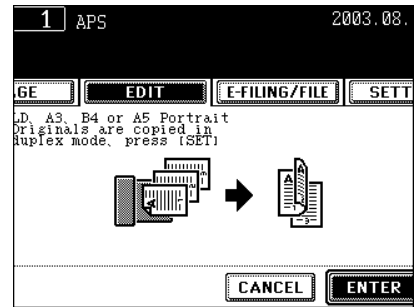

14. DIRECTION OF DUPLEX COPY IMAGES IN "2 TO 2"

When copying under the mode of 2-Sided Originals to 2-Sided-Copies, this function allows you to rotate the backside of the original to be copied by 180. It is useful when 'open to left' (Book) originals need to be copied in 'open to top' (Tablet), and the opposite condition is available.

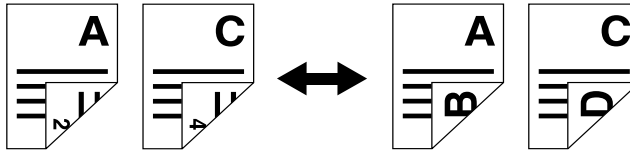

5

1 Place paper in the drawer(s).

- "1.SETTING COPY PAPER" Page 36

2 Place the original(s).

- "2.SETTING ORIGINALS" Page 45

3 Press the [2 → 2 DUPLEX] in the basic menu.

- "5.DUPLEX COPYING" Page 87

4 Press the [EDIT] button to enter the edit menu, and then press the [BOOK ↔ TABLET] button.

- If the desired function buttons are not displayed, press the [Next] button to change the menu.

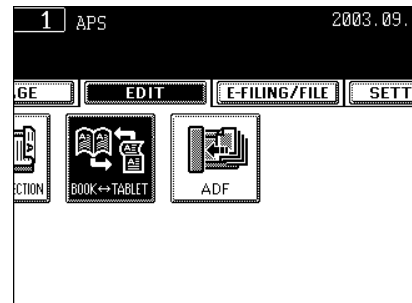

5 Press the [ENTER] button.

• Select other copy modes as required

6 Press the [START] button.

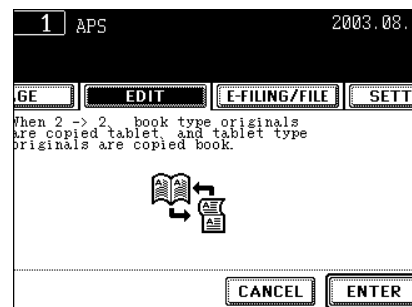

15. CONTINUOUS/SINGLE ORIGINAL FEEDING

When using the optional reversing automatic document feeder, you can select the continuous feed mode (default setting) so that multiple (or single) originals are continuously fed in one by one, or the single feed mode where an original is automatically pulled in when you insert it and starts being copied.

* When setting the different size of originals "Mixed-sized Originals"  Page 70

Continuous Feed Mode

1 Place paper in the drawer(s).

- "1.SETTING COPY PAPER"  Page 36

2 Place the original(s) on the reversing automatic document feeder (optional).

- "When Using the Reversing Automatic Document Feeder (optional)"  Page 49

3 Press the [EDIT] button to enter the edit menu, and then press the [ADF] button.

- If the desired function buttons are not displayed, press the [NEXT] button to change the menu screen.

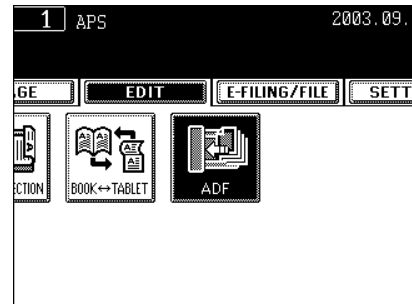

4 Press the [ADF] button.

• Select other copy modes as required.

5 Press the [START] button.

Tip

When the number of originals is too large to be set at one time, you can divide the originals into 2 to 10 sets and set them one after another. To do so, place the first set of originals first, and press the [CONTINUE] button while the scanning is in progress. After they have been scanned, place the next set of originals that should be scanned.

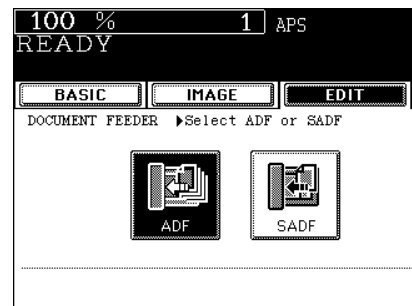

Single-feed Mode

1 Place paper in the drawer(s).

- "1.SETTING COPY PAPER" Page 36

2 Press the [EDIT] button to enter the edit menu, and then press the [ADF] button.

- If the desired function buttons are not displayed, press the [NEXT] button or [Prev] button to change the menu.

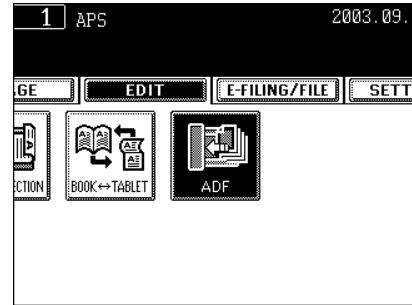

3 Press the [SADF] button.

- Select other copy modes as required.

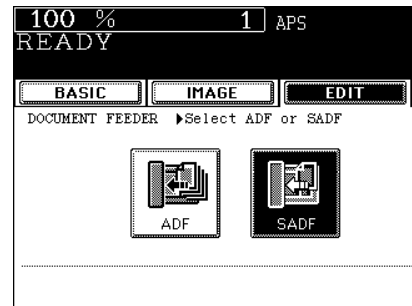

4 Place the original on the reversing automatic document feeder (optional).

- "Inside the Single-feed Mode" Page 51
- The original is automatically pulled in and the screen changes as shown on the right.
- If there are more originals, set them in the same way. (The same operation is performed whether or not you press the [YES] button.)

5 After all originals have been fed through the reversing automatic document feeder, press the [FINISHED] button.

- Copying begins.

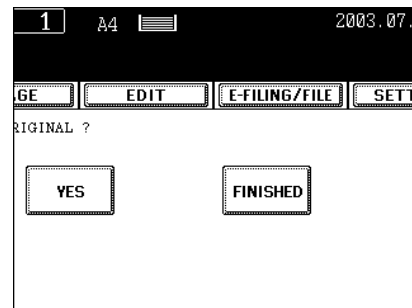



6. STORING ORIGINALS

1. STORE TO e-FILING	136
2. SAVE AS FILE	139
3. ENTERING LETTERS	141

1. STORE TO e-FILING

In this function, the copied original data can be stored in the e-Filing. During copying, you can print it at the same time, as required. After storing the original data, you can print it at any time.

To store the original data, you can specify the public box or one of user boxes. The public box is a pre-set box since the installation of the equipment, and it will be used to store documents that any user may need to work with. The user box is the one created by the user, and, if password is set, you need to enter the password correctly.

Before storing the original data in e-Filing, you need to set up the user boxes. For setting up the user boxes and printing the stored documents, see "2.SETTING UP BOX"  Page 214 and "5.PRINTING STORED DOCUMENT"  Page 219, "10.e-FILING"  Page 211.

* The hard disc could be at fault. Be sure to backup the stored documents by downloading them with a client PC using the File Downloader. See the [e-Filing Guide] for details.

Tip

You can also store the scanned original data in the e-Filing using the scanning operation. ("2.SCAN TO e-FILING"  Page 147) When you use the original data with the client PC via network, it is recommended to store the original data using the scanning operation rather than using the copy operation explained here.

6

1 Place the original(s).

- "2.SETTING ORIGINALS"  Page 45
- If there is not enough space in the hard disc, the number of originals that can be stored may be restricted.
- When you want to store and copy the original(s) simultaneously, select the copy modes as required.

2 Press the [E-FILING/FILE] button on the basic screen to enter the filing menu.

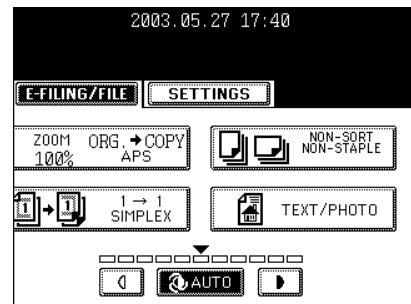

3 Press the [STORE TO E-FILING] button.

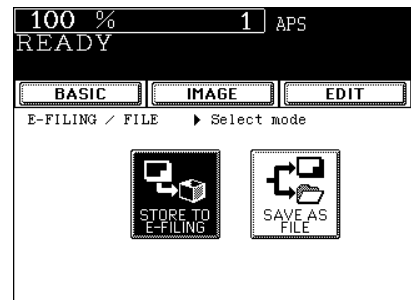

4 Press the [BOX/FOLDER] button.

- The box list is displayed.

100 % 1 APS
READY

BASIC IMAGE EDIT

STORE TO E-FILING ▶ Select box and folder

BOX/FOLDER BOX NUMBER :
BOX NAME :
FOLDER NAME :
DOCUMENT NAME DOC030527

5 Select the box in which you want to store the data, and then press the [ENTER] button.

- Select either the "Public box" or the "User box".
- See the procedure of "e-FILING" for setting a new user box. "2.SETTING UP BOX" Page 214

BOX LIST ▶ Select Box

BOX NUMBER :

Public Box

001 Sales 1

002 Sales 2

003 Sales 3

6 The document list in the selected box is displayed. When you want to store the original(s) in an existing folder, select the folder and press the [OPEN FOLDER] button. If you have no folder to be selected, press the [ENTER] button.

- If you want to store the data in the user box, password entry may be required to display the list.
- Setting the folder can be made only when this equipment is connected with the TopAccess. For details, see the [e-FILING Guide].

2003.05.27 17:44

	Date,Time	Paper	Pages
	26,15:11	A4	5
	26,15:14	A4	10
	26,15:15	A4	2
	26,16:25	A4	1
	26,18:11	A4	1

CANCEL ENTER 1 / 2 Next

7 Press the [DOCUMENT NAME] button to enter the name of the scanned data.

- The letter entry menu ("3.ENTERING LETTERS" Page 141) is displayed. A document name can contain up to 64 letters.

100 % 1 APS
READY

BASIC IMAGE EDIT

STORE TO E-FILING ▶ Select box and folder

BOX/FOLDER BOX NUMBER : 01
BOX NAME : S
FOLDER NAME :
DOCUMENT NAME DOC030527

8 Press the [ENTER] button.

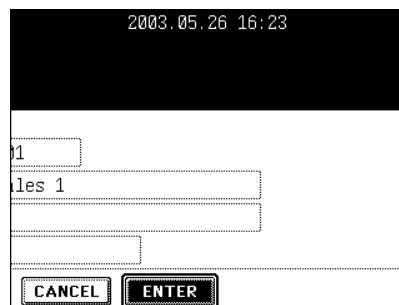

9 When “PRINT THIS DOCUMENT?” appears, press the [YES] button to store and print the document.

- If you want to store the document without printing, press the [NO] button.

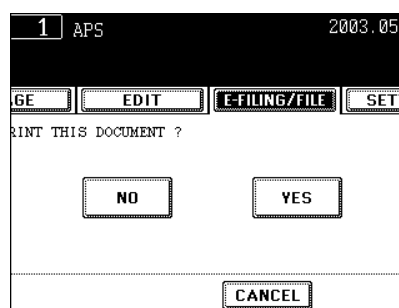

10 Press the [START] button.

- Storing the original starts.

11 “NEXT ORIGINAL?” appears. If you have the other originals to be stored, press the [YES] button. If not, press the [FINISHED] button.

- When the original is set on the reversing automatic document feeder (optional) to be scanned in the Continuous Feed mode, this screen is not displayed.

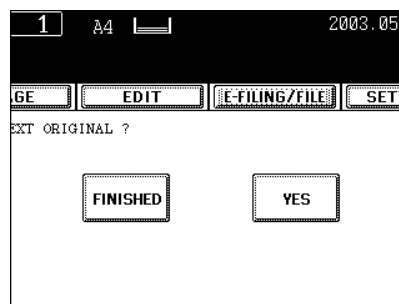

12 Press the [FUNCTION CLEAR] button to finish this job.

6

2. SAVE AS FILE

In this SAVE AS FILE function, the copied original data can be sent and stored to the hard disc in the equipment or the specified PC. You can administrate and edit the stored data in the e-Filing in the equipment directly from the user's PC via network.

- * The network administrator has to make settings for storing the original data to the PCs. For details, see the [Network Administrator's Guide].
- * The hard disc could be at fault. Be sure to backup the stored documents by downloading them with a client PC using the File Downloader. See the [e-Filing Guide] for details.

1 Place the original(s).

- "2.SETTING ORIGINALS"  Page 45
- If there is not enough space in the hard disc, the number of originals that can be stored may be restricted.
- Select the copy mode as required.

2 Press the [E-FILING/FILE] button on the basic screen to enter the filing menu.

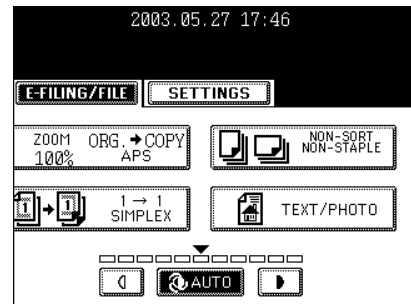

3 Press the [SAVE AS FILE] button.

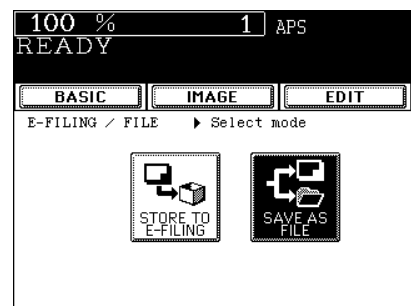

4 Press the [FILE NAME] button to enter the file name of the stored data.

- The letter entry menu is displayed.
A file name can contain up to 64 letters.

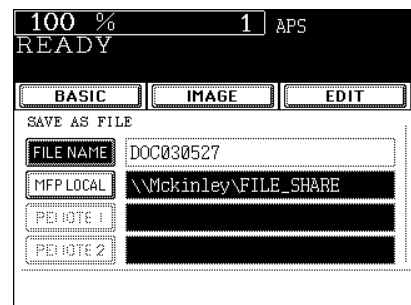

5 Select the desired location.

- [MFP LOCAL]: Select when the originals should be stored in the hard disc in the main equipment. The original data will be stored under the directory path shown on the screen.
- [REMOTE 1], [REMOTE 2]: Select when the originals should be stored in the hard disc of user's PC via server. The administrator has to make settings to select "REMOTE 1" or "REMOTE 2" using the TopAccess.
For details, see the [Network Administrator's Guide].

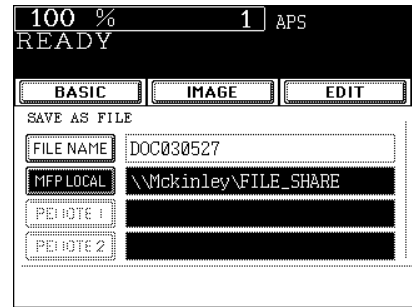

6 Select the desired file format.

- The SCAN folder is automatically created and the original data will be stored into this folder. If you select "TIFF (SINGLE)", an additional folder with the name you entered in step 4 is further created, and each page will be stored into this folder. You can access the original data with the client PC via network, by opening the FILE_SHARE folder in the equipment's hard disc.

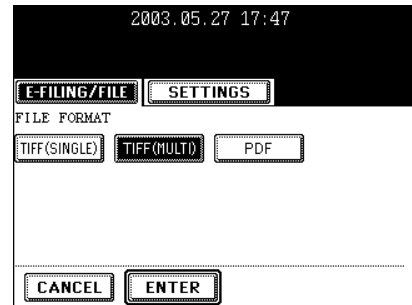

7 After all the settings have been made, press the [ENTER] button.

8 Press the [START] button.

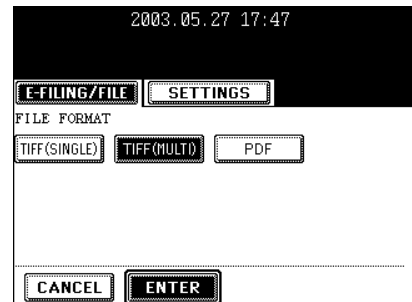

9 "NEXT ORIGINAL?" appears. If you have the other originals to be stored, press the [YES] button. If not, press the [FINISHED] button.

- This screen is displayed when the scanning is performed from the original glass. It is not displayed from the reversing automatic document feeder (optional).

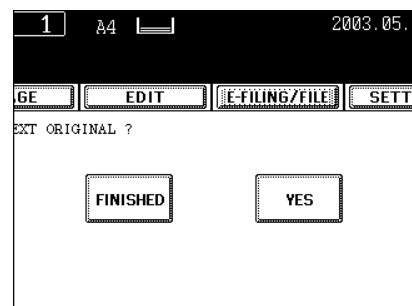

3. ENTERING LETTERS

The following screen is provided for entering letters.

* To enter numbers, use the digital keys on the control panel.

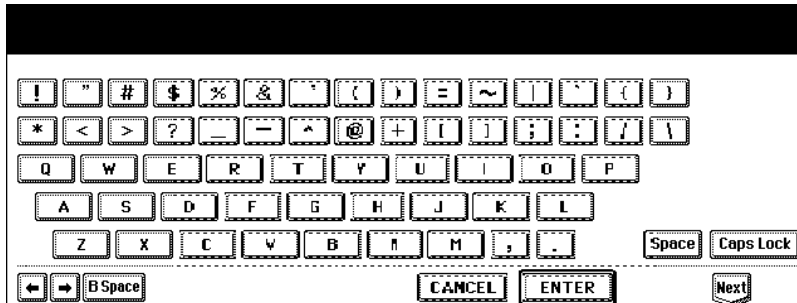

The following buttons are used to enter letters.

- [CapsLock] Press this button to switch capital letters and small letters.
- [B Space] Press this button to delete the letter before the cursor.
- [Space] Press this button to enter a space.
- [←][→] Press these buttons to move the cursor.
- [ENTER] Press this button to fix all entered letters.
- [Cancel] Press this button to cancel entry of letters.
- [Next] Press this button to display the special characters.



7. SCANNING THE IMAGES

1. SCAN SETTING IN THE TOUCH PANEL	144
2. SCAN TO e-FILING	147
3. SCAN TO FILE.....	151
4. SCAN TO E-MAIL	155

1. SCAN SETTING IN THE TOUCH PANEL

If the scanning function is used, originals set on the reversing automatic document feeder (optional) or on the original glass can easily be scanned as image data.

The scanned image data can be sent or stored to the destinations of "SCAN TO e-FILING", "SCAN TO FILE" or "SCAN TO E-MAIL".

* See the [e-Filing Guide] about how to save the data to PCs.

Tip

Scanning cannot be performed while a job is printing.

Maximum Number of Sheets that can be Stored



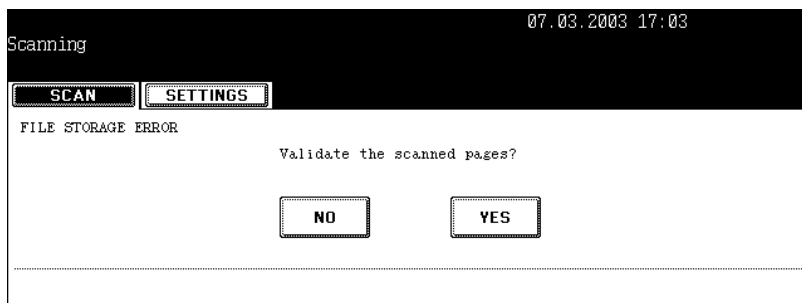

Up to 1,000 sheets of A4 size can be stored per 1 job or until the memory becomes full.

When exceeding the above limit during the scanning the following screen is displayed. The scanned data is printed by pressing the [YES] button and it is deleted by pressing the [NO] button.



Scanning Procedure

1 Place the original(s).



- "2.SETTING ORIGINALS"  Page 45
- Originals acceptable to be set "2.SETTING ORIGINALS"  Page 45
- When placing an original on the glass "When Placing an Original on the Glass"  Page 47
- When placing the original on the reversing automatic document feeder (optional) "15.CONTINUOUS/SINGLE ORIGINAL FEEDING"  Page 133

2 Press the [SCAN] button on the control panel to enter the scan menu.

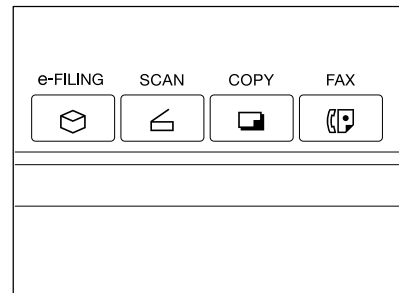
- The basic scan menu is displayed.



3 Select the desired scan mode and press the button.

- The screen on the right is displayed as an example of selecting SCAN TO E-FILING.
- To select SCAN TO E-FILING "2.SCAN TO e-FILING"  Page 147
- To select SCAN TO FILE "3.SCAN TO FILE"  Page 151
- To select SCAN TO E-MAIL "4.SCAN TO E-MAIL"  Page 155

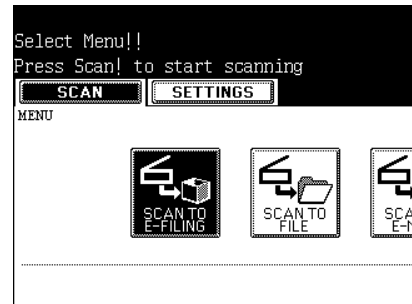

4 Set the scanning conditions using the buttons on the touch panel and the digital keys.

- Press the [Next] or [Prev] button to switch the screen and make necessary settings. After having completed all the settings, press the [ENTER] button.

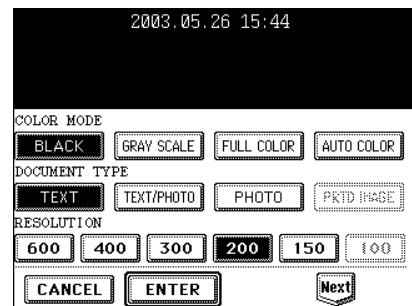

5 Press the [SCAN!] button.

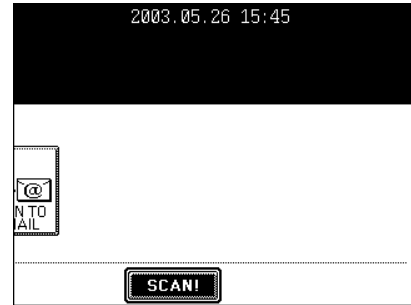

6 “To continue, place document on glass. And press the Scan!” appears. If you want to continue scanning, press the [CONTINUE] button. If you want to finish scanning, press the [JOB FINISH] button.

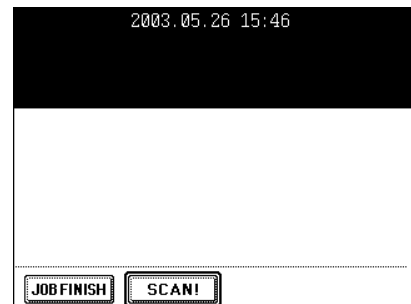
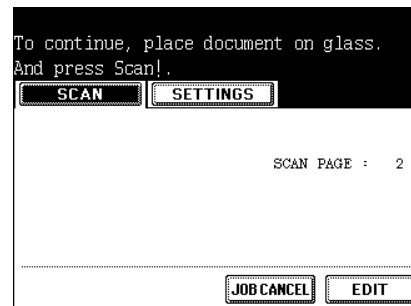

- When the original is set on the reversing automatic document feeder (optional) to be scanned in the Continuous Feed mode, this screen is not displayed.
- If you want to cancel the storage of the scanned data, press the [JOB CANCEL] button.
- You can change the setting of original type and scanning conditions using the [EDIT] button before pressing the [SCAN!] button.



2. SCAN TO e-FILING

In this function, the scanned original data can be stored in the e-Filing. During scanning, you can perform the SCAN TO e-FILING or the SCAN TO E-MAIL simultaneously, as required. After storing the original data, you can print it at any time.

To store the original data, you can specify the public box or one of user boxes. The public box is a pre-set box since the installation of the equipment, and it will be used to store documents that any user may need to work with. The user box is the one created by the user, and, if password is set, you need to enter the password correctly.

Before storing the original data in e-Filing, you need to set up the user boxes. For setting up the user boxes and printing the stored documents, see "2.SETTING UP BOX"  Page 214 and "5.PRINTING STORED DOCUMENT"  Page 219.

* The hard disc could be at fault. Be sure to backup the stored documents by downloading them with a client PC using the File Downloader. See the [e-Filing Guide] for details.

Tip

You can also store the copied original data in the e-Filing using the copy operation. ("1.STORE TO e-FILING"  Page 136) However, when you use the original data with the client PC via network, it is recommended to store the original data using the scanning operation explained here, rather than using the copy operation.

7

1 Place the original(s).

- "2.SETTING ORIGINALS"  Page 45
- If there is not enough space in the hard disc, the number of originals that can be scanned may be restricted.

Tip

The reversing automatic document feeder (optional) enables consecutive scanning of more than one original.

2 Press the [SCAN] button on the control panel to enter the scan menu.

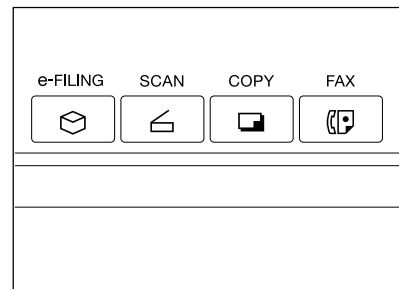

3 Press the [SCAN TO E-FILING] button.

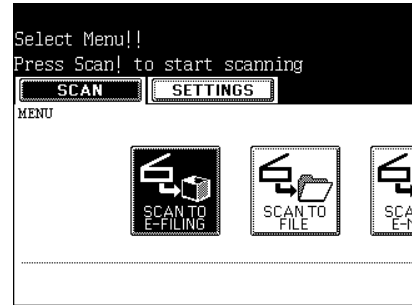

4 Press the [BOX/FOLDER] button.

- The box list is displayed.

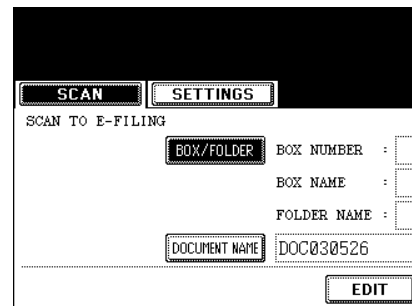

5 Select the box in which you want to store the data and press the [ENTER] button.

- Select either the "Public box" or the "User box".
- See the procedure of "e-FILING" for setting the user box. "2.SETTING UP BOX" Page 214
- Entering letters "3.Entering Letters" Page 141

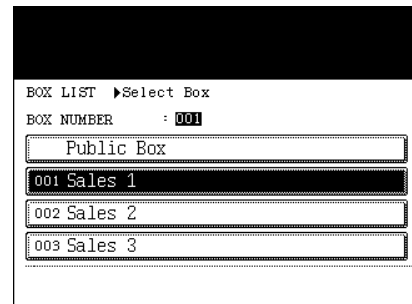

6 The document list in the selected box is displayed. When you want to store the original(s) in an existing folder, select the folder and press the [OPEN FOLDER] button. If you have no folder to be selected, press the [ENTER] button.

- If you want to store the data in the user box, password entry may be required to display the list.
- Setting the folder can be made only when this equipment is connected with the TopAccess. See the [e-Filing Guide].

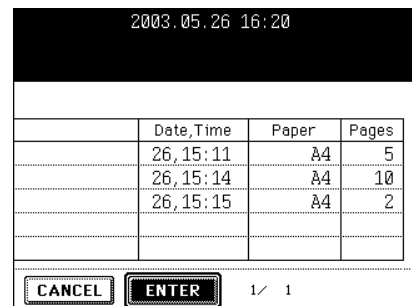

7 Press the [DOCUMENT NAME] button to enter the name of the scanned data.

- The letter entry menu (see "3. ENTERING LETTERS" Page 141) is displayed. A document name can contain up to 64 letters.
- Press the [ENTER] button on the letter entry menu.

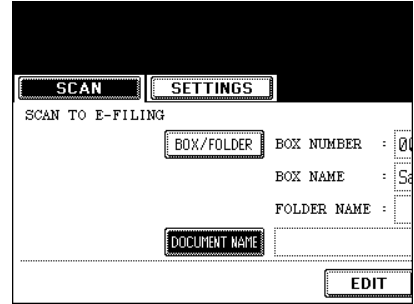

8 Press the [EDIT] button to set the original type and size, and the scanning conditions.

- Press the [Next] or the [Prev] button to switch the screen and make necessary settings. After having completed all the settings, press the [ENTER] button.

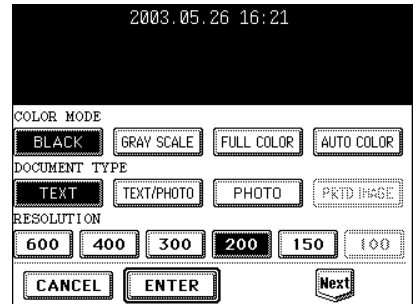
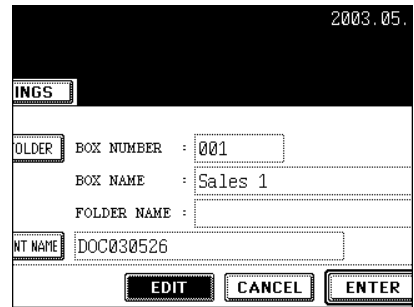

9 Press the [ENTER] button.

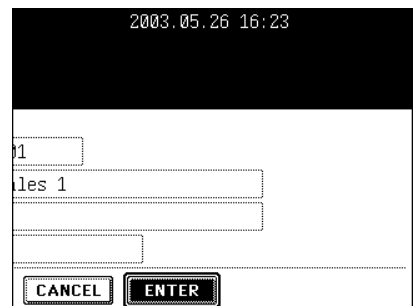

10 Press the [SCAN!] button.

Tip

If the "SCAN TO FILE" or the "SCAN TO E-MAIL" button is pressed to make the setting before pressing the [SCAN!] button, the specified 2 jobs can be performed simultaneously.

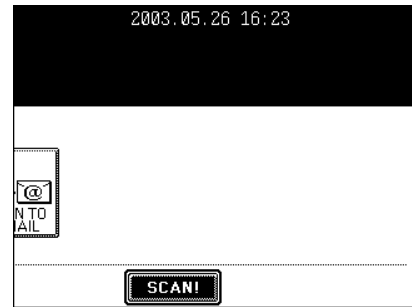

11 "To continue, place document on glass. And press Scan!" appears. If you want to finish scanning, press the [JOB FINISH] button.

- If you want to continue scanning, press the [SCAN!] button.
- When the original is set on the reversing automatic document feeder (optional) to be scanned in the Continuous Feed mode, this screen is not displayed.

Tips

- You can change the original size, type and scanning conditions by pressing the [EDIT] button for the next scanning.
- If you want to cancel the storage of the scanned data, press the [JOB CANCEL] button.

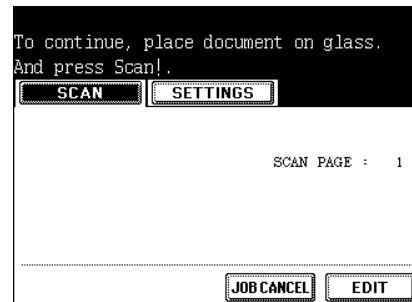
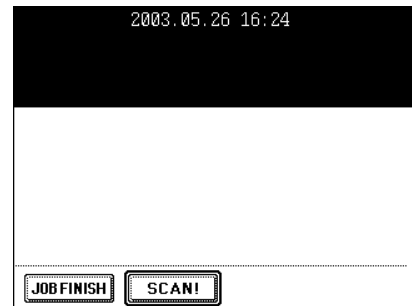

3. SCAN TO FILE

In this SCAN TO FILE function, the scanned original data can be sent and stored to the hard disc in the equipment or the specified PC. You can administrate and edit the stored data in the e-Filing in the equipment directly from the user's PC via network.

- * The network administrator has to make settings for storing the original data to the PCs. For details, see the [Network Administrator's Guide].
- * The hard disc could be at fault. Be sure to backup the stored documents by downloading them with a client PC using the File Downloader. See the [e-Filing Guide] for details.

1 Place the original(s).

- "2.SETTING ORIGINALS"  Page 45
- If there is not enough space in the hard disc, the number of originals that can be scanned may be restricted.

Tip

The reversing automatic document feeder (optional) enables consecutive scanning of more than one original.

2 Press the [SCAN] button on the control panel to enter the scan menu.

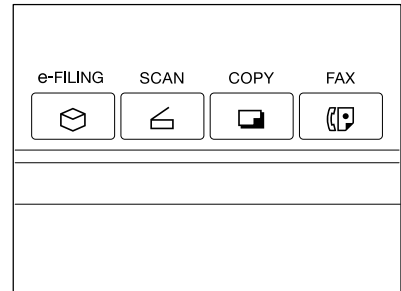

3 Press the [SCAN TO FILE] button.

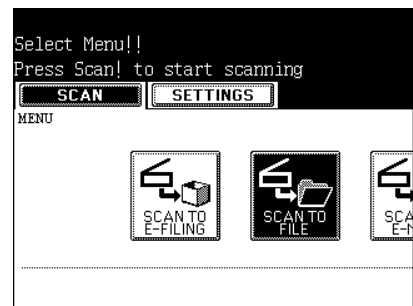

4 Press the [FILE NAME] button to enter the file name of the scanned data.

- The letter entry menu is displayed. A file name can contain up to 64 letters.
- After entering the letters, be sure to press the [ENTER] button.

5 Select the desired location.

- [MFP LOCAL]: Select when the originals should be stored in the hard disc in the main equipment. The original data will be stored under the directory path shown on the screen.
- [REMOTE 1], [REMOTE 2]: Select when the originals should be stored in the hard disc of user's PC via server. The administrator has to make settings to select [REMOTE 1] or [REMOTE 2] using the TopAccess. For details, see the [Network Administrator's Guide].

Tip

You can select 2 locations to store the data from [MFP LOCAL], [REMOTE 1] and [REMOTE 2].

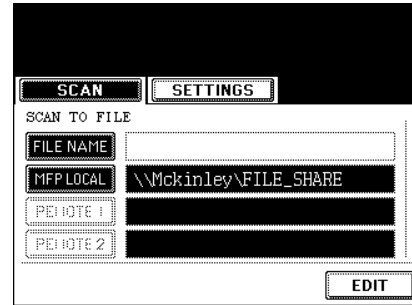

6 Select the file format.

- The SCAN folder is automatically created and the original data will be stored into this folder. If you select "TIFF (SINGLE)", an additional folder with the name you entered in step 4 is further created, and each page will be stored into this folder. You can access the original data with the client PC via network, by opening the FILE_SHARE folder in the equipment's hard disc.

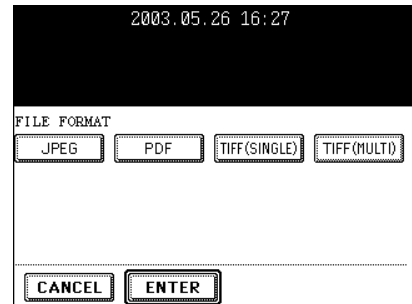

7 Press the [EDIT] button, and then set the original type and the scanning conditions.

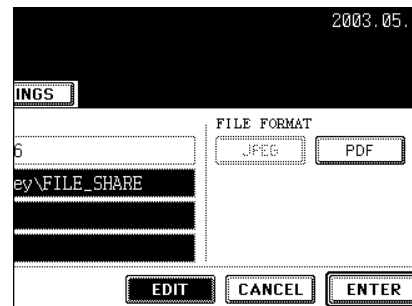

- Press the [Next] or [Prev] button to switch the screen and make necessary settings.

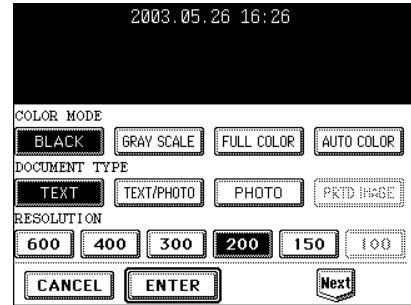

8 Press the [ENTER] button.

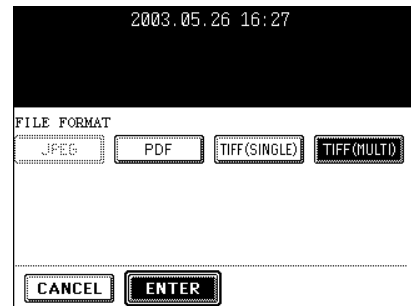

9 Press the [SCAN!] button.

Tip

If the [SCAN TO E-FILING] or the [SCAN TO E-MAIL] button is pressed to make the setting before pressing the [SCAN!] button, the specified 2 jobs can be performed simultaneously.

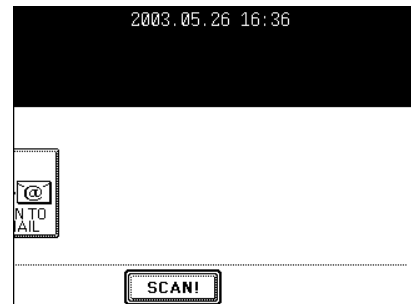

10 “To continue, place document on glass. And press Scan!” appears. If you want to finish scanning, press the [JOB FINISH] button.

- If you want to continue scanning, press the [SCAN!] button.
- When the original is set on the reversing automatic document feeder (optional) to be scanned in the Continuous Feed mode, this screen is not displayed.

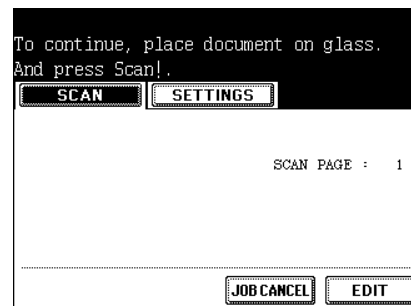

Tips

- You can change the original size, type and scanning conditions by pressing the [EDIT] button for the next scanning.
- If you want to cancel the storage of the scanned data, press the [JOB CANCEL] button.

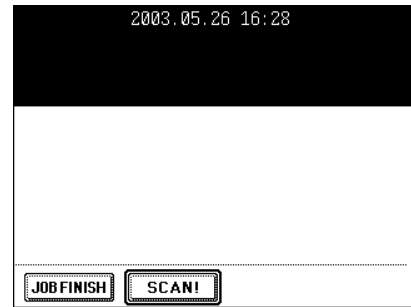

4. SCAN TO E-MAIL

In this function, the scanned data can be sent to the specified E-mail address as an attached file. After finishing the setting for the E-mail transmission, the settings for SCAN TO E-FILING or SCAN TO FILE can be made and the data can be scanned simultaneously.

* To use SCAN TO E-MAIL, the configuration of the equipment needs to be set by the network administrator.

1 Place the original(s).

- "2.SETTING ORIGINALS"  Page 45
- If there is not enough space in the hard disc, the number of originals that can be scanned may be restricted. According to the network environment, available data amount may be restricted.

Tip

The reversing automatic document feeder (optional) enables consecutive scanning of more than one original.

2 Press the [SCAN] button on the control panel to enter the scan menu.

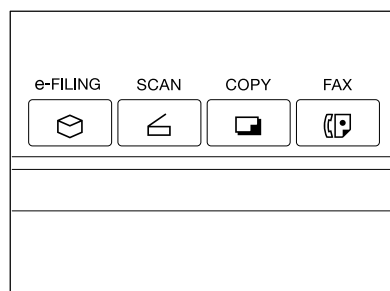

3 Press the [SCAN TO E-MAIL] button.

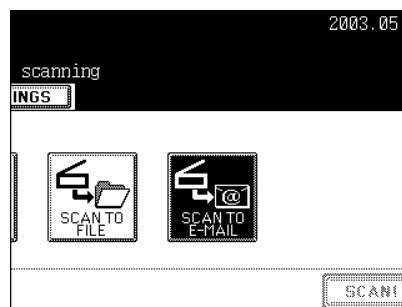

4 Press the [E-MAIL TO] button and select the address.

- Press the [E-MAIL ADDRESS] button when you want to enter the address directly with the soft keyboard.
- When the address book appears, select the address which you want to send to.
- See the [User Function Guide] for entering and setting the address.
- To return the SCAN TO E-MAIL menu from the address book, press the [RETURN] button.

The screenshot shows the 'SCAN TO E-MAIL' menu with two tabs: 'SCAN' and 'SETTINGS'. The 'SCAN' tab is active. Below the title, there are four buttons: 'E-MAIL TO', 'SUBJECT', 'BODY', and 'FILE NAME'. The 'E-MAIL TO' button is highlighted with a black background. To the right of the 'SUBJECT' button, the text 'Scanned from Mckinley' is visible. Below the 'FILE NAME' button, the text 'DOC030526' is visible. An 'EDIT' button is located at the bottom right of the menu.

5 Press the [SUBJECT] button and enter the subject of the E-mail.

- A subject can contain up to 256 letters.
"3. ENTERING LETTERS" Page 141

The screenshot shows the 'SCAN TO E-MAIL' menu with the 'SUBJECT' button highlighted. The 'E-MAIL TO' field is empty. The 'SUBJECT' button is highlighted with a black background. The 'EDIT' button is at the bottom right.

6 Press the [BODY] button and enter the text body, etc.

- A body can contain up to 1,000 letters.

The screenshot shows the 'SCAN TO E-MAIL' menu with the 'BODY' button highlighted. The 'SUBJECT' field contains 'Scanned from Mckinley'. The 'BODY' button is highlighted with a black background. The 'EDIT' button is at the bottom right.

7 Press the [FILE NAME] button and name the scanned data.

- A file name can contain up to 64 letters.
"3. ENTERING LETTERS" Page 141

The screenshot shows the 'SCAN TO E-MAIL' menu with the 'FILE NAME' button highlighted. The 'SUBJECT' field contains 'Scanned from Mckinley'. The 'FILE NAME' button is highlighted with a black background. The 'EDIT' button is at the bottom right.

8 Select the file format.

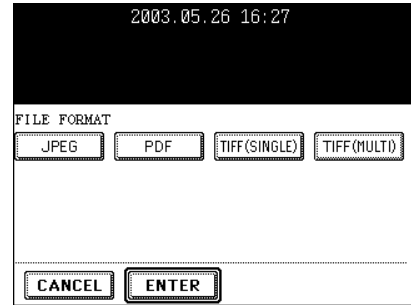

9 Press the [EDIT] button and set the original size and type.

- After step 9 is finished, press the [NEXT] button.

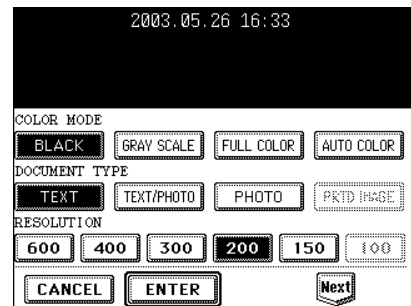
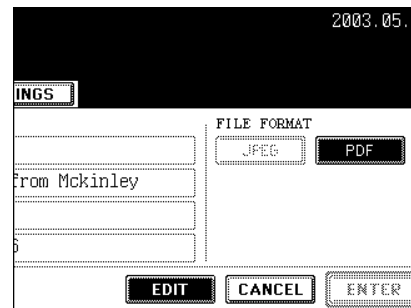

10 Set the size of the attached data.

- Image data are divided into some small blocks to be sent.
FRAGMENT MESSAGE SIZE (KB): NONE, 64 KB, 128 KB, 256 KB, 512 KB, 1024 KB, 2048 KB
Press the [Next] or [Prev] button to switch the screen and make necessary settings.

Tip

The volume of the high-resolution image data may be very large. When sending E-mail, be careful not to exceed the mail server capacity of both the transmitter and the receiver.

- If the software for E-mail is not able to divide the data properly, resend it after setting smaller fragment message size.
- If the data size exceeds the specified size, it is divided into the specified size to be sent.
- If the E-mail receiver uses a different controller and the attached file is PDF format, the attached file can not be printed.

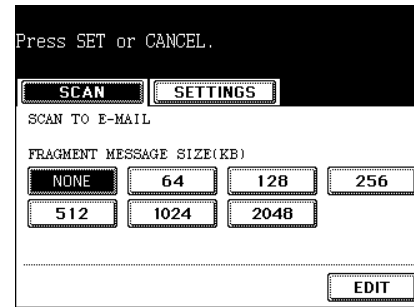

11 Press the [FROM ADDRESS] button to enter the sender's address, and then press the [ENTER] button.

- Entering Letters "3.Entering Letters" Page 141

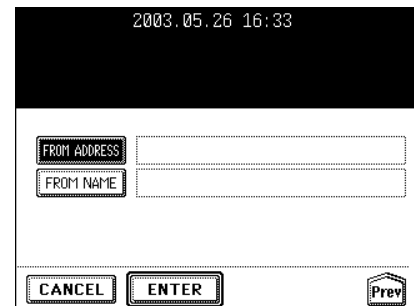

12 Press the [FROM NAME] button to enter the sender's name, and then press the [ENTER] button.

- Entering Letters "3.Entering Letters" Page 141

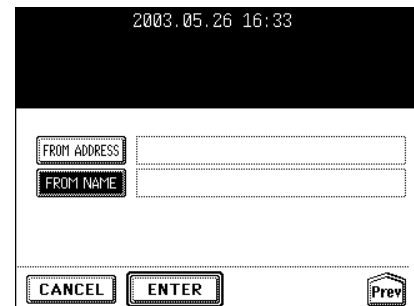

13 After all the settings are entered, press the [ENTER] button.

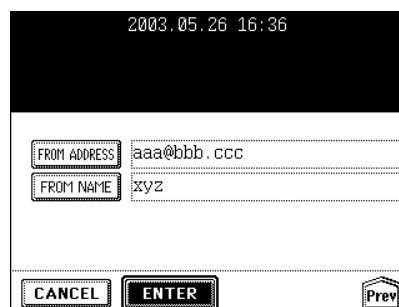

14 Press the [SCAN!] button.

- If the [SCAN TO E-FILING] or the [SCAN TO E-MAIL] button is pressed to make the setting before pressing the [SCAN!] button, the specified 2 jobs can be performed simultaneously.

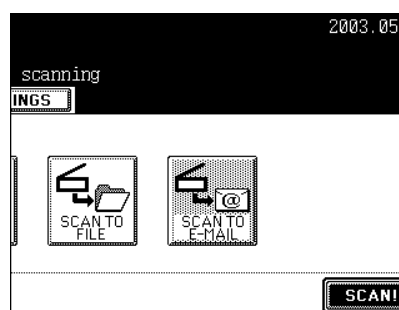



7

8. INTERNET FAX

1. INTERNET FAX	162
2. SENDING INTERNET FAX.....	164
Setting the Transmission Conditions.....	164
Specifying the Recipients.....	167
Advanced Function	177
3. RECEIVING INTERNET FAX	180

1. INTERNET FAX

Internet Fax function provides the ability to transmit a scanned original as an E-mail, with an attached TIFF-S file. Since an Internet line is used instead of a phone line, the communication cost can be reduced.

In this function, an E-mail address is specified in place of a phone number to transmit a scanned original to the Internet Fax equipment or the client computers.

When the Internet Fax is received, it is automatically output like regular Fax.

* The administrator needs to configure the network settings for Internet Fax to function. See the [Network Administrator's Guide].

Precaution for Internet Transmission

Transmissions using the Internet Fax function are the same as E-mail transmissions.

Before you start to use the Internet Fax function, it is recommended that you read this section and understand the precautions for Internet transmission.

- The Internet Fax sends a document to the E-mail server of Internet and it does not send via the PSTN* alike regular facsimile transmissions.
- Internet transmission has low security. It is recommended that you use regular facsimile transmission when confidential document is sent.
- It may take a considerable amount of time for the recipient to receive the document because of the line traffic in the Internet.
- If the document being transmitted has a large amount of data, it may not be successfully sent due to the configuration of the E-mail server.

* PSTN (Public Switched Telephone Network) is a global telephone system enables to communicate in worldwide using copper wires to transmit analog data.

Internet Fax Transmission Overview

The following is an overview of the various transmissions that can be performed using the Internet Fax function.

- Internet Fax to Internet Fax

The equipment can send a document to another Internet Fax equipment through the Internet or Intranet. The document is sent as an E-mail.

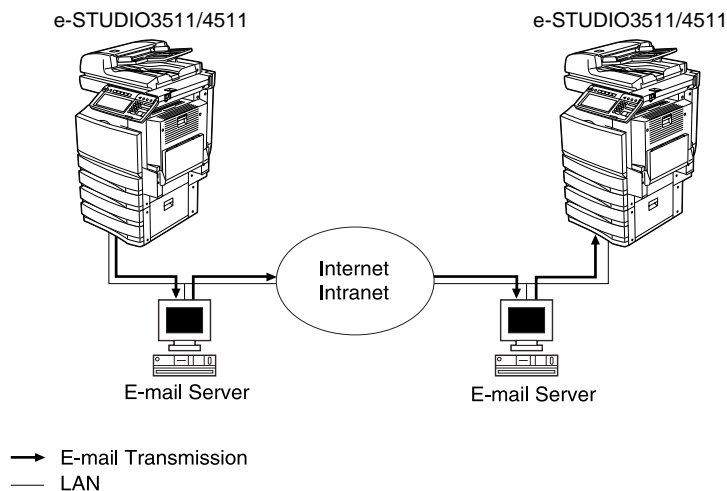

- Internet Fax to/from Client Computers

The equipment can send a document as an E-mail to client computers through the Internet or Intranet. The client computers can send an E-mail to the equipment as well.

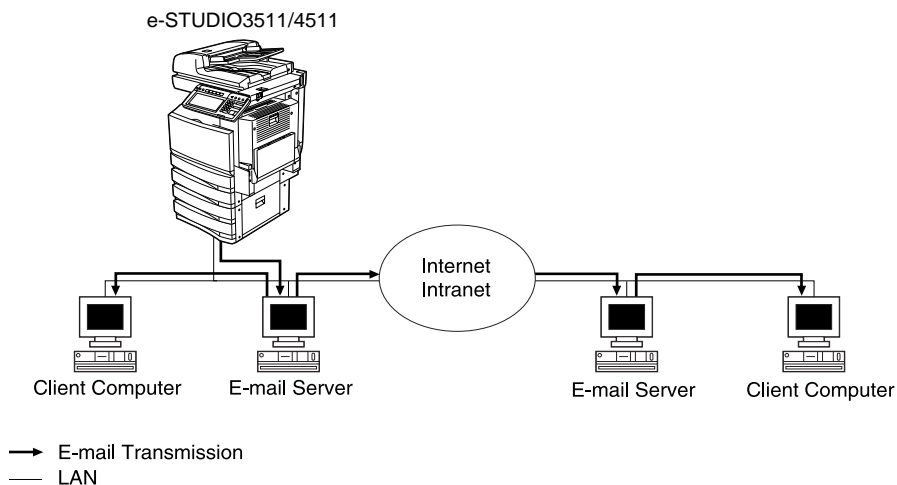

Note

- The client computer receives TIFF-S images when the equipment sends a document using the Internet Fax function.
- The equipment can only print out text files and TIFF images. When sending E-mail from the client computer to this equipment using the E-mail application, files other than text or TIFF images cannot be sent. For Available Format, see "Receiving Modes" Page 180.

2. SENDING INTERNET FAX

Setting the Transmission Conditions

Set the resolution, the image quality mode, exposure, original size, subject and body of originals. Whenever a transmission is completed, the condition will automatically return to the default setting. The following describes the setting of each item.

- Resolution:

Set the resolution before you scan the original to be sent.
STANDARD, FINE, U-FINE

* For the Internet Fax, the original is sent in FINE though U-FINE is selected.

- Image Quality Mode:

Set the image quality mode before you scan the original to be sent.
TEXT, PHOTO/TEXT, TEXT

* The transmission time may be longer than usual in case the PHOTO/TEXT or the PHOTO mode is selected.

- Exposure:

Set the image density according to the contrast of the original to be sent.
AUTO, MANUAL (11 steps)

* In the automatic exposure mode, the digital copier automatically judges the contrast of the original, and selects the optimum contrast.

* In the manual exposure mode, you can adjust the contrast manually in 11 steps.

- Original Size:

Set the scanning size of the original to be sent.

AUTO: The size of the original is automatically determined before it is scanned.

SPECIFIED SIZE: The original is scanned in the specified size regardless of its actual size. Use this mode when you are using non-standard size paper or you want to limit the area of the original to sent.

* When originals are placed in the reversing automatic document feeder, they are scanned in the AUTO mode. You can specify the size only when the original is placed on the original glass.

* For the Internet Fax, all originals are sent in A4 size. The larger original than A4 size is reduced to A4 size, and the smaller original than A4 size is put with a margin.

- Subject/Body:

Subject and body can be added to the originals to be sent.

8

1 Press the [FAX] button on the control panel.

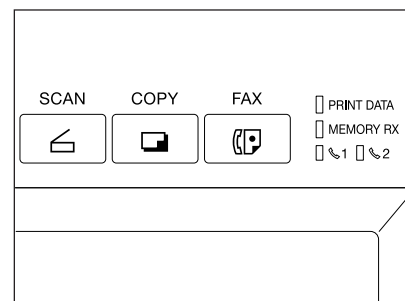

2 Press the [ADDRESS] button to display the address menu, and then press the [OPTION] button.

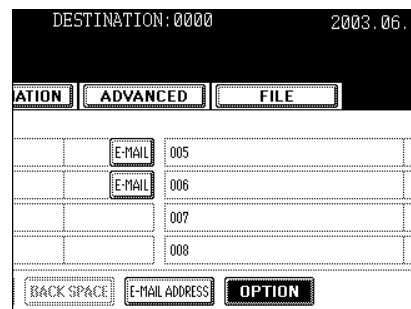

3 After selecting each transmission condition, press the [ENTER] button.

- Press the [Prev] or [Next] button to switch the menu.
- The buttons shaded in the menu on the right are the default settings.

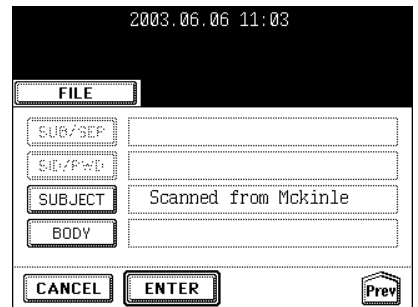
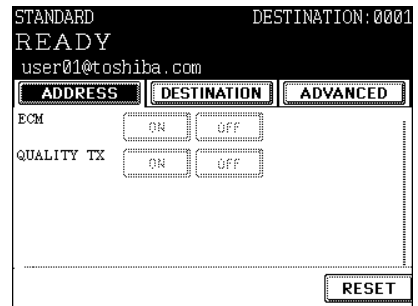
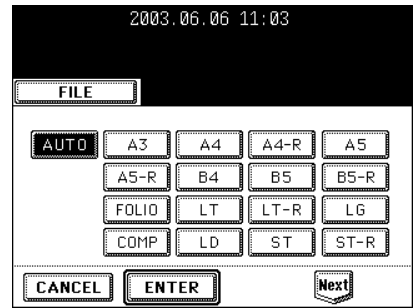
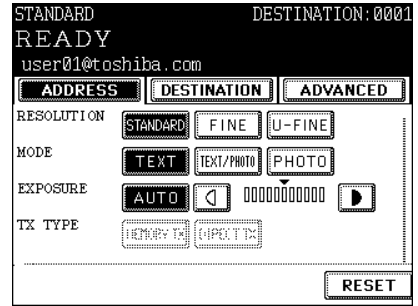

Specifying the Recipients

- Direct entry: You can enter the E-mail address directly with the letter entry menu to send the original.
- Address book entry: You can specify the other party that has been registered into the address book.
- Group entry: Originals are sent to the recipients that have been already specified as a group at a time.
- Multi-address transmission: The same original can be sent to 2 or more recipients in a single operation.

Direct Entry

1 Press the [FAX] button on the control panel.

2 Place the original(s).

- "2.SETTING ORIGINALS" Page 45

3 Press the [OPTION] button and set the transmission conditions.

- "Setting the Transmission Conditions" Page 164

4 Set the advanced function as required.

- "Advanced Function" Page 177

5 Press the [ADDRESS] button to display the address menu, and then press the [E-MAIL ADDRESS] button.

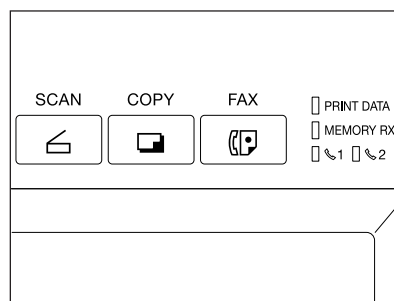

6 Enter the E-mail address.

- Entering letters "3.Entering Letters" Page 141

7 Press the [START] button.

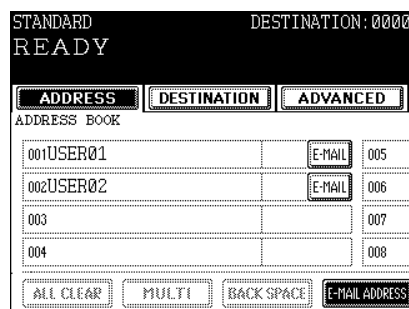

Address Book Entry

- It is necessary to previously register the address book.
See the [User Function Guide] for registering the address book.

1 Press the [FAX] button on the control panel.

2 Place the original(s).

- "2.SETTING ORIGINALS" Page 45

3 Press the [OPTION] button and set the transmission conditions.

- "Setting the Transmission Conditions" Page 164

4 Set the advanced function as required.

- "Advanced Function" Page 177

5 Press the [ADDRESS] to display the address menu.

- 1 screen can show 8 destinations.
To view the destinations not displayed on the screen, press the [Prev] or [Next] button to scroll through the screens.
- If a group list is displayed, press the [ADDRESS BOOK] button.

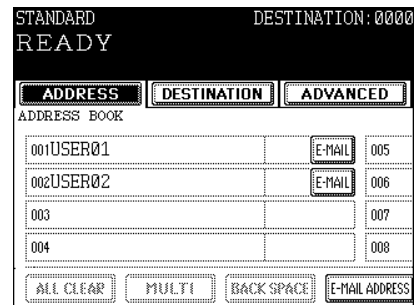
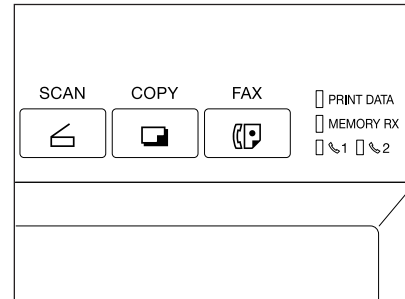

6 Press the [E-MAIL] button of destination.

- You can search for the recipient by ID number or Address.
- Searching by ID Number "Searching by ID Number" Page 171
- Searching by Address "Searching by Address" Page 173

7 Press the [START] button.

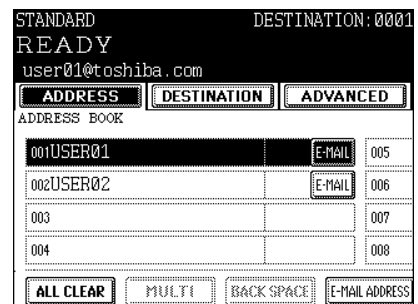

Group Entry

- It is necessary to previously enter the recipients into the group.
See the [User Function Guide] for creating groups.

1 Press the [FAX] button on the control panel.

2 Place the original(s).

- "2.SETTING ORIGINALS"  Page 45

3 Press the [OPTION] button and set the transmission conditions.

- "Setting the Transmission Conditions"  Page 164

4 Set the advanced function as required.

- "Advanced Function"  Page 177

5 Press the [ADDRESS] to display the address menu, and then press the [GROUP] button.

- 1 screen can show 8 destinations.

To view the destinations not displayed on the screen, press the [Prev] or [Next] button to scroll through the screens.

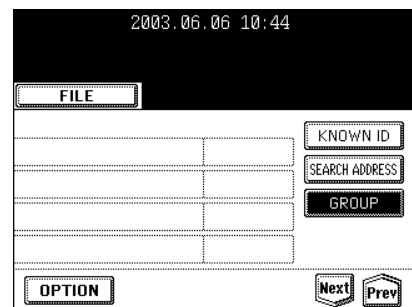
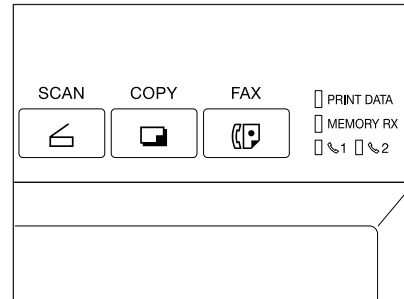

6 Press the recipient group you want to send to. To check the specified group member, press the [CONTENTS] button.

- You can search for the recipient by ID number or group.
- Searching by ID Number "Searching by ID Number" Page 171
Searching by Group "Searching by Address" Page 173

7 Press the [START] button.

STANDARD DESTINATION: 0002
READY

ADDRESS DESTINATION ADVANCED

GROUP

001GROUP01	CONTENTS	005
002		006
003		007
004		008

ALL CLEAR MULTI BACK SPACE E-MAIL ADDRESS

STANDARD DESTINATION: 0002
READY

ADDRESS DESTINATION ADVANCED

GROUP

001GROUP01	CONTENTS	005
002		006
003		007
004		008

ALL CLEAR MULTI BACK SPACE E-MAIL ADDRESS

STANDARD DESTINATION: 0002
READY

ADDRESS DESTINATION ADVANCED

001USER01	E-MAIL	
002USER02	E-MAIL	

RETURN

Searching by ID Number

When selecting the recipient entered in the address and the group, you can immediately search them by the ID number on the screen.

- 1 Press the [FAX] button on the control panel.**
- 2 Place the original(s).**
 - "2.SETTING ORIGINALS" Page 45
- 3 Press the [OPTION] button and set the transmission conditions.**
 - "Setting the Transmission Conditions" Page 164
- 4 Set the advanced function as required.**
 - "Advanced Function" Page 177
- 5 Press the [ADDRESS] button to display the address menu, and then press the [KNOWN ID] button.**
- 6 Key in the desired ID number using the digital keys, and press the [ENTER] button.**

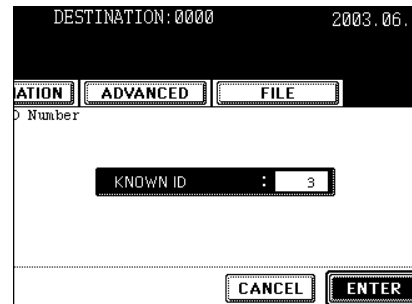
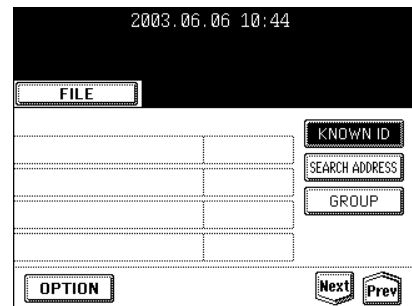
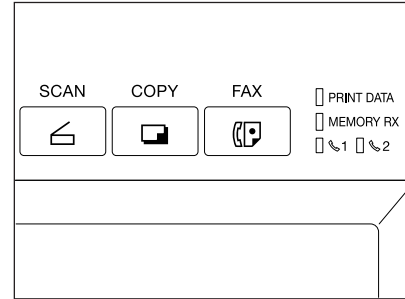

7 Press the [E-MAIL] button of destination.

- 1 screen can show 8 destinations.
To view the destinations not displayed on the screen, press the [Prev] or [Next] button to scroll through the screens.

Tips



- To continue searching by the ID number, press the [KNOWN ID] button.
- To continue searching by the address ("Searching by Address"  Page 173), press the [SEARCH ADDRESS] button.

STANDARD		DESTINATION: 0001	
READY			
user03@toshiba.com			
ADDRESS	DESTINATION	ADVANCED	
ADDRESS BOOK			
001USER01	E-MAIL	005	
002USER02	E-MAIL	006	
003USER03	E-MAIL	007	
004		008	
ALL CLEAR		MULTI	BACK SPACE
		E-MAIL ADDRESS	

8 Press the [START] button.

Searching by Address

When selecting the recipient entered in the address and group, pressing a letter button displays the recipient whose names start with the letter on the screen, which makes it easy to choose the desired recipient.

- 1 Press the [FAX] button on the control panel.**
- 2 Place the original(s).**
 - "2.SETTING ORIGINALS"  Page 45
- 3 Press the [OPTION] button and set the transmission conditions.**
 - "Setting the Transmission Conditions"  Page 164
- 4 Set the advanced function as required.**
 - "Advanced Function"  Page 177
- 5 Press the [ADDRESS] button to display the address menu, and then press the [SEARCH ADDRESS] button.**

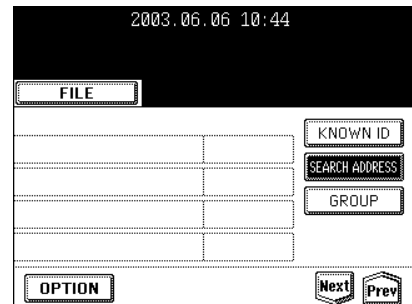
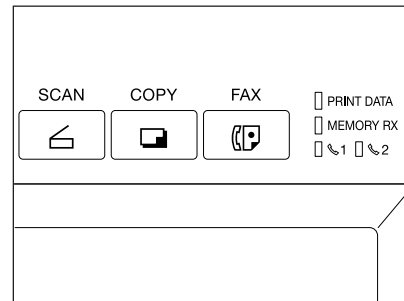

6 Press the button of item that you want to search.

7 Enter the letter or the number, and then press the [ENTER] button.

- Entering Letters "3.ENTERING LETTERS"  Page 141

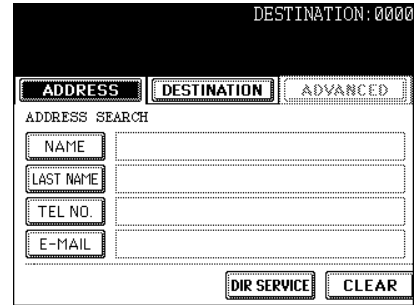
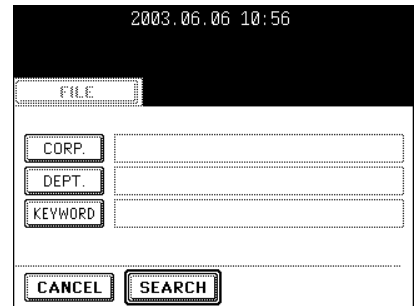
8 Press the [SEARCH] button.

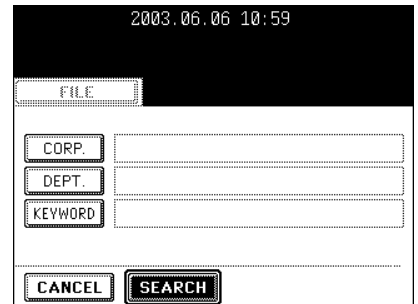

9 Press the [E-MAIL] button of destination, and then press the [ENTER] button.

- 1 screen can show 8 destinations.

To view the destinations not displayed on the screen, press the [Prev] or [Next] button to scroll through the screens.

Tips

- To continue searching by the address, press the [SEARCH ADDRESS] button. (See Step 5.)
- To continue searching by the ID number ("Searching by ID Number"  Page 171), press the [KNOWN ID] button. (See Step 5 of "Searching by ID Number")

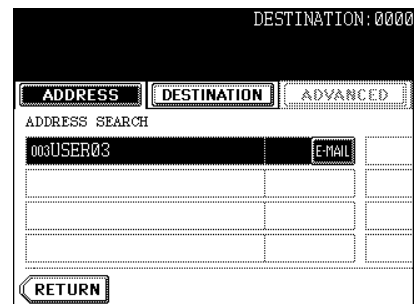

10 Press the [START] button.

Multi-address Transmission

The multi-address transmission function allows you to send the same original to 2 or more recipients in a single operation, which can be done by combining direct, address book and group entry.

The following show the number of destinations that can be entered according to how the recipient is specified:

- By direct entry only: 400 destinations
- By address book entry only: 400 destinations
- By group entry only: 200 groups (400 destinations per 1 group)
- By combining direct, address book and group entry: 400 destinations

1 Press the [FAX] button on the control panel.

2 Place the original(s).

- "2.SETTING ORIGINALS" Page 45

3 Press the [OPTION] button and set the transmission conditions.

- "Setting the Transmission Conditions" Page 164

4 Set the advanced function as required.

- "Advanced Function" Page 177

5 Specify the recipient.

- To continuously enter E-mail address after having specified them by means of entering directly, press the [MULTI] button, and then enter the next address. You do not need to press the [MULTI] button for the address book or the group entry.
- The selected destinations can be confirmed by selecting the [DESTINATION] button. "Confirming the Destinations" Page 176

Tips

- To cancel the other party's address during the direct entry, press the [CLEAR] button on the control panel.
- To cancel the other party specified by the address or the group, press the highlighted button again. To cancel all specified recipient, press the [ALL CLEAR] button.
- To cancel the other party specified by the direct entry, press the [DESTINATION] button to enter the destination menu, and then cancel it. "Confirming the Destinations" Page 176

6 Press the [START] button.

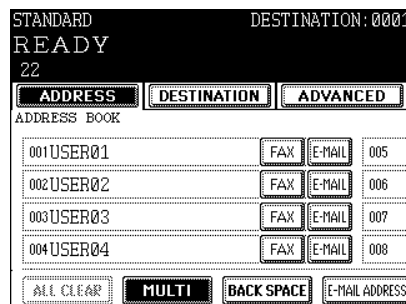
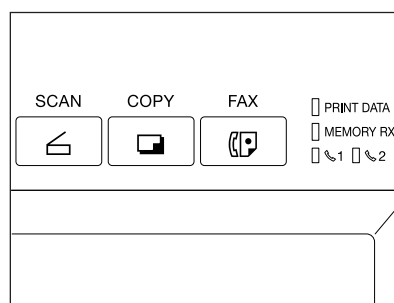

Confirming the Destinations

After specifying of the multiple destinations by such as Multi-address Transmitting, you can confirm these addresses in the list by pressing the [DESTINATION] button. Also, you can delete the addresses by pressing the [DELETE] button.

1 Press the [DESTINATION] button.

- 1 screen can show 8 destinations.
- To view destinations which are not displayed on the screen, press the [Prev] or [Next] button to scroll through the screens.

DESTINATION: 0003

ADDRESS	DESTINATION	ADVANCED
DESTINATION		
USER01	E-MAIL	
USER02	E-MAIL	
USER03	E-MAIL	
DELETE		

2 Select the destination that you want to delete, and then press the [DELETE] button.

DESTINATION: 0003

ADDRESS	DESTINATION	ADVANCED
DESTINATION		
USER01	E-MAIL	
USER02	E-MAIL	
USER03	E-MAIL	
DELETE		

Advanced Function

The following advanced function can be used.

- 2-sided original TX: 2-sided originals can be sent using the reversing automatic document feeder.
- Priority TX: You can send originals prior to the reserved transmissions.

Sending 2-sided Originals

You can scan and send 2-sided originals using the reversing automatic document feeder (optional). Whenever a transmission is completed, the condition will automatically return to the default setting.

Tip

To send the 2-sided originals, the reversing automatic document feeder (optional) needs to be installed in this equipment.

- Setting originals when sending LT/A4 2-sided originals

To set the originals on the reversing automatic document feeder (optional), change the direction of original feeding depending on the bound position.

- 1: 2-sided originals bound with open to left
- 2: 2-sided originals bound with open to top

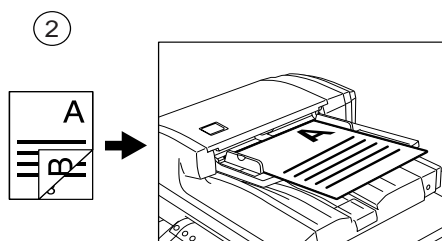
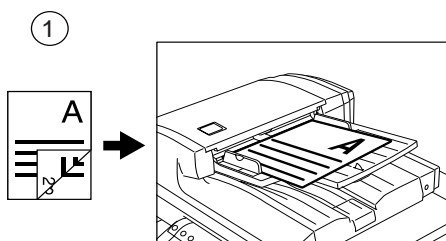

1 Press the [FAX] button on the control panel.

2 Place the original(s).

- "2.SETTING ORIGINALS" Page 45

3 Press the [OPTION] button and set the transmission conditions.

- "Setting the Transmission Conditions" Page 164

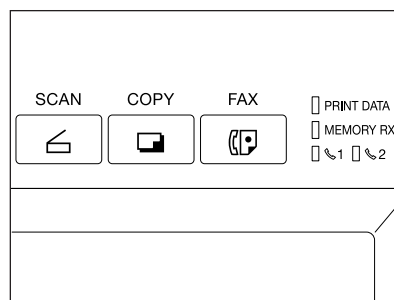

- 4** Press the [ADVANCED] button to display the advanced menu, and then press the [2-SIDED SCAN] button.

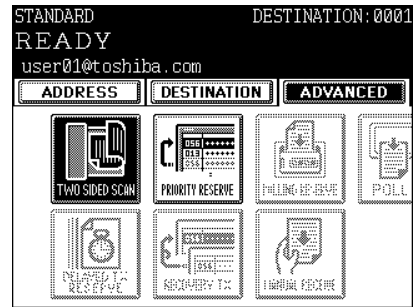

- 5** Select the original type either the [BOOK] or [TABLET] button, and then press the [ENTER] button.

- 6** Specify the recipient.

- "Specifying the Recipients" Page 167

- 7** Press the [START] button.

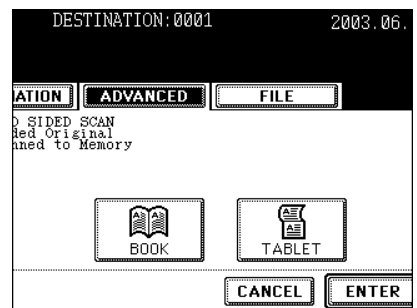

8

Priority Transmission

Priority TX allows you to execute a transmission prior to the other reserved transmissions.

- You can use 'Direct Entry' and 'Address Dialing' to specify the recipients.
- Priority TX can be performed only for 1 transmission.

- 1** Press the [FAX] button on the control panel.
- 2** Place the original(s).
- "2.SETTING ORIGINALS" Page 45
- 3** Press the [OPTION] button and set the transmission conditions.

- "Setting the Transmission Conditions" Page 164

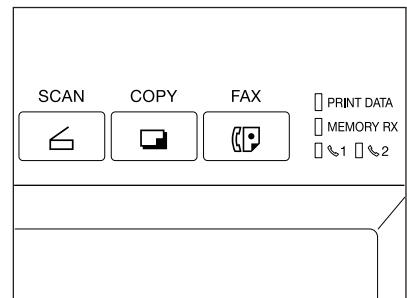

4 Press the [ADVANCED] button to display the advanced menu, and then press the [PRIORITY RESERVE] button.

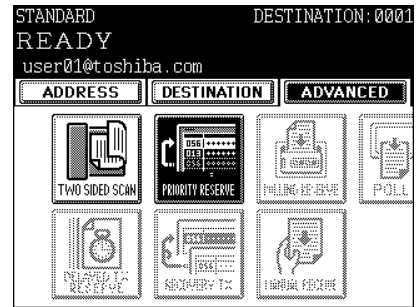

5 Press the [ENTER] button.

6 Specify the recipient.

- "Specifying the Recipients"  Page 167

7 Press the [START] button.

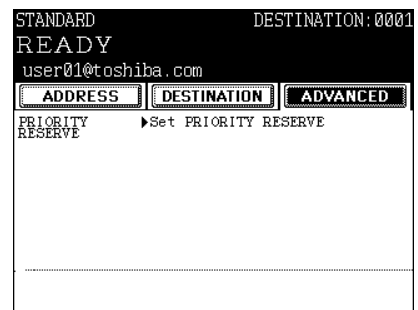

3. RECEIVING INTERNET FAX

Receiving Modes

The methods to receive an Internet Fax vary according to the type of protocols used for receiving an E-mail.

When POP3* is selected for the Receive Mode:

- The equipment accesses the E-mail server at specified intervals to check whether any E-mail has been delivered. If an E-mail has been delivered, the equipment will automatically retrieve and print out the E-mail.
- When the [CHECK E-MAIL] button is pressed, the equipment manually accesses the E-mail server to check whether any E-mail has been delivered. If an E-mail has been delivered, the equipment receives and prints out the E-mail.

* POP (Post Office Protocol) is a protocol to retrieve the E-mail message from a mail server. Most E-mail applications use POP. POP3 is a newer version of the POP protocol.

When SMTP* is selected for Receive Mode

- When SMTP is selected for Receive Mode, the [CHECK E-MAIL] button is disabled. As soon as an E-mail is received by the E-mail server via the internet, the mail server will transfer the E-mail to this equipment. For more details, see "Receiving from SMTP server".

* SMTP (Simple Mail Transfer Protocol) is a server protocol to transfer the E-mail message between servers. Most E-mail system uses SMTP to transfer the E-mail messages over the Internet.

For how to set the receiving mode and how to print the received Internet Fax, see the [Network Administrator's Guide]

8

Note

Available Format:

The TIFF-FX images, TIFF images scanned by the scanner and the text data can be printed. In addition, the resolution of the TIFF-FX image must be 8 x 3.85, 8 x 7.7 or 8 x 15.4 (dot/mm). The resolution of the TIFF images scanned by the scanner must be 200 x 100, 200 x 200, 200 x 400, 400 x 400 or 600 x 600 (dpi). If the received E-mail contains files that are not the ones described above, an error message will be displayed on the touch panel.

To avoid such a case, you can print the report when an error occurs for E-mail printing and also forwarding this E-mail to another E-mail address can be set.

If you want to print the report when an error occurs for E-mail printing, set up "Enable Print E-mail Error". If you want to forward the E-mail to another E-mail address when an error occurs, set up "Enable E-mail Error Transfer" and "E-mail Error Transfer Address".

See the "Setting up the E-mail Print" in the [Network Administrator's Guide].

Receiving from POP3 Server

To automatically receive the Internet Fax from the E-mail server, set up the "POP3 Time".

Checking whether any E-mail has been delivered at specified intervals will be performed automatically. (Default setting: every 10 minutes)

For setting the "POP3 Time", see the [Network Administrator's Guide].

1 Press the [USER FUNCTIONS] button on the control panel.

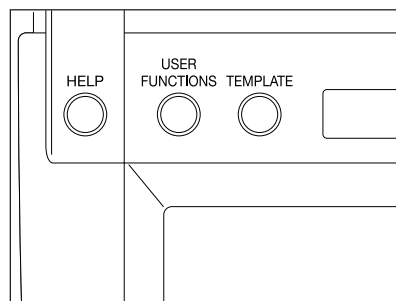

2 Press the [USER] button, and then press the [CHECK E-MAIL].

- Checking whether any E-mail has been delivered starts.

3 Checking completes.

- If the Internet Fax is received, "RECEIVING E-mail" appears on the screen upper right. Next, "NEW E-mail RECEIVED" appears for 2 seconds. Then, printing the Internet Fax starts.
- If no Internet Fax is received, "CURRENTLY NO E-mail" appears on the screen upper right for 2 seconds.

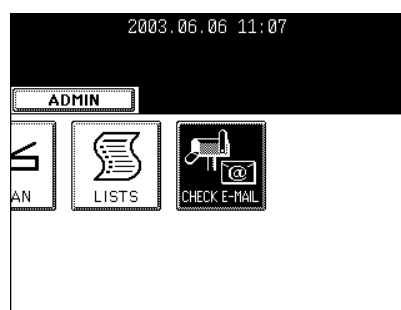

Receiving from SMTP Server

Once an E-mail to this equipment or an E-mail is delivered through the Internet, this equipment will automatically retrieve E-mail from the SMTP server using the SMTP transmission.

When the Receive Mode is set to SMTP, the sub-domain for this equipment must be assigned at the SMTP server to receive E-mail or enable the Offramp Gateway transmission. In this case, this equipment works as one of the E-mail servers.

When the SMTP server receives an E-mail intended for the sub-domain of this equipment, the SMTP server will transfer the E-mail to this equipment using the SMTP transmission. If an E-mail is sent to the E-mail address of this Internet Fax equipment, it will print the E-mail out.

Please see the OFFRAMP GATEWAY SETUP (See the [User Function Guide]) for further details.

Note

When the Receive Mode is set to SMTP the equipment cannot retrieve an E-mail from the mail server manually.



9. JOB STATUS

1. JOB STATUS	184
2. PRINT JOB LIST.....	185
3. PROOF PRINT JOB	188
4. PRIVATE PRINT JOB	190
5. WHEN USING THE DEPARTMENT CODES	192
6. CONFIRMING THE STATUS OF FAX/INTERNET FAX JOB	194
7. CONFIRMING THE STATUS OF SCAN	195
8. LOG LIST.....	196
9. ADDRESS REGISTRATION FROM LOG LISTS.....	199
10.PRINTING SEND/RECEIVE LOG LIST OF FAX	201
11.STATUS	202
12.ERROR CODE.....	204

1. JOB STATUS

[JOB STATUS] enables:

- To show the list of printing, Internet Fax and scanning jobs in the waiting status
- To show the status of the print, transmission, reception, scanning log and print
- To perform the execution, pause, deletion and movement of the waiting jobs.

4 jobs are listed on each screen (page). The jobs for 250 pages (1,000 jobs) are available to display. Press the [Next] button to display the 5th job or later, and press the [Prev] button to display the previous page.

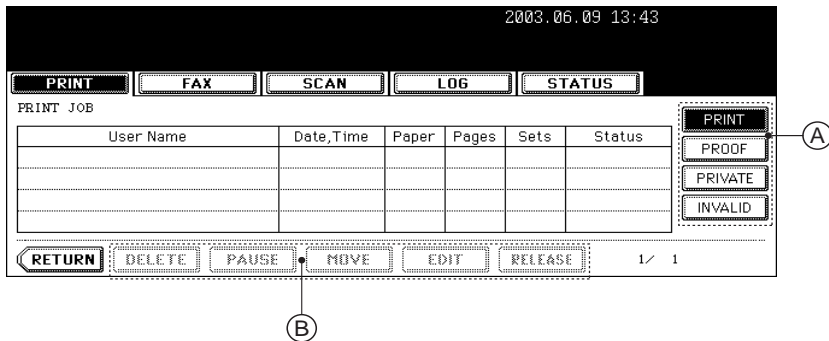

- Items of list

User Name: Name of registered user

Date, Time: Date and time at the time of registration

Paper: Paper size to be printed

Pages: Number of pages to be printed

Sets: Number of sets to be printed

Status: Status of jobs or specified time for Delayed TX Reservation

- Buttons

The display of the buttons (B) are changed by selecting the buttons (A) of the print job list on the above screen.

2. PRINT JOB LIST

Print Job enables to display the status of print jobs transmitted between the equipment and network controller, and perform the deletion, pause, movement and print of the jobs.

Press the [Next] button to display the 5th job or later, and press the [Prev] button to display the previous page.

Deleting a Job

1 Press the [JOB STATUS] button on the control panel to display the JOB STATUS screen.

- Displayed screen is the print job list screen.

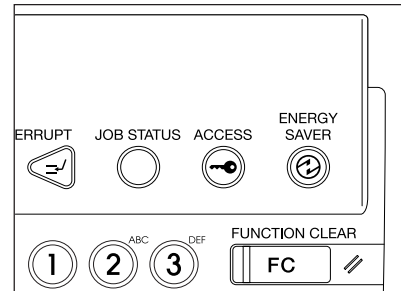

2 Press the job on the list you want to delete.

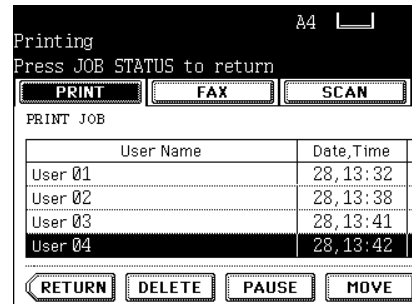

3 Press the [DELETE] button.

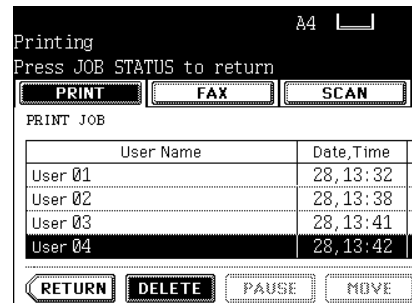

- 4** “Delete OK?” appears. Press the [DELETE] button to delete the job.

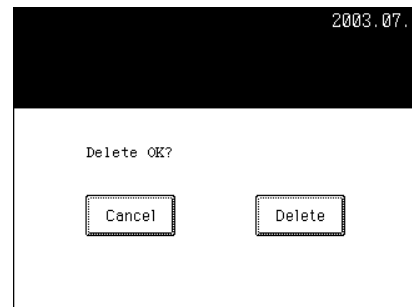

Pausing and Resuming a Print Job

- 1** Press the user name on the list you want to interrupt.
- 2** Press the [PAUSE] button.
- 3** To resume the job, press the [RELEASE] button.

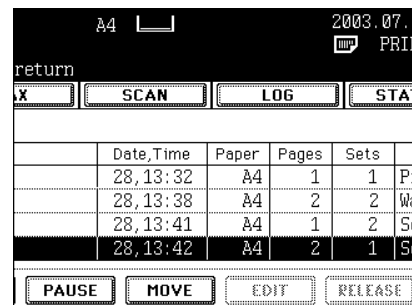

Moving a Print Job

- 1 Press the user name on the list you want to move.

Printing A4 []
Press JOB STATUS to return

User Name	Date,Time
User 01	28,13:32
User 02	28,13:38
User 03	28,13:41
User 04	28,13:42

PRINT JOB

PRINT FAX SCAN

RETURN DELETE PAUSE MOVE

- 2 Press the [MOVE] button.

Printing A4 []
Press JOB STATUS to return

User Name	Date,Time
User 01	28,13:32
User 02	28,13:38
User 03	28,13:41
User 04	28,13:42

PRINT JOB

PRINT FAX SCAN

RETURN DELETE PAUSE MOVE

- 3 Specify the position of the order.

Printing A4 []
Press JOB STATUS to return

User Name	Date,Time
User 01	28,13:32
User 02	28,13:38
User 03	28,13:41
User 04	28,13:42

PRINT JOB

PRINT FAX SCAN

RETURN DELETE PAUSE MOVE

- (Ex.) Press the 1st user name to move the target job to the 2nd.

Printing A4 []
Press JOB STATUS to return

User Name	Date,Time
User 01	28,13:32
User 04	28,13:42
User 02	28,13:38
User 03	28,13:41

PRINT JOB

PRINT FAX SCAN

RETURN DELETE PAUSE MOVE

3. PROOF PRINT JOB

This function performs the proof print when the [PROOF] button is previously specified with the application. The print job specified for proof print is listed. 1 set is printed as a proof print before the specified number of sets are printed. After it completes, remaining print job is performed as the normal print job. In addition, before performing as the normal print job, changing the number of sets and deleting a job are available.

* For the Proof print, see the [Print Guide].

Performing the Proof Print

1 Press the [PROOF] button.

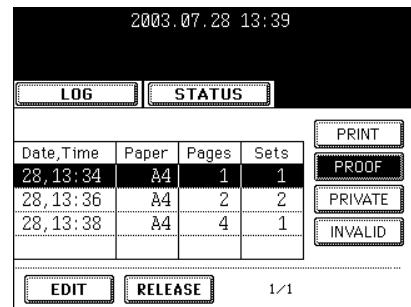

2 Proof print job list is displayed. Press the user name on the list you want to print.

- If the relevant job is not displayed, press the [Next] or [Prev] button to switch the screen.

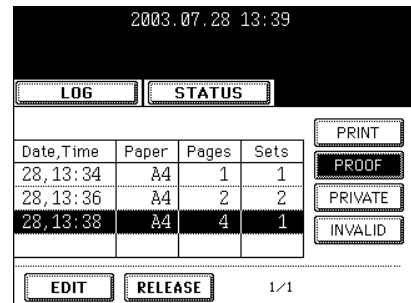

3 Press the [RELEASE] button. The job is moved to the normal print job to print it.

Tip

After confirming the printed paper of the proof print, press the [EDIT] button and key in the desired number to change the number of sets. And then press the [RELEASE] button to continue the normal print job.

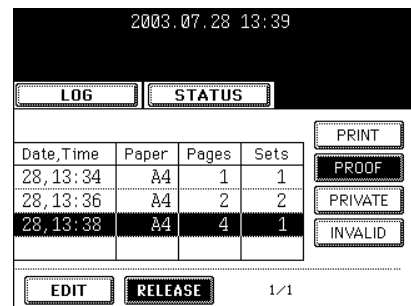

Deleting a Job

1 Press the [PROOF] button.

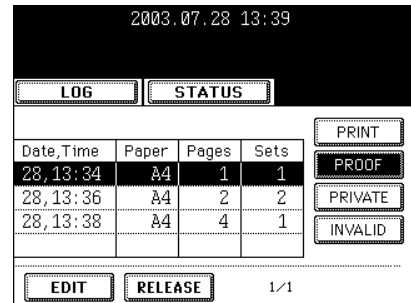

2 Proof print job list is displayed. Press the user name on the list which you want to delete.

3 Press the [DELETE] button.

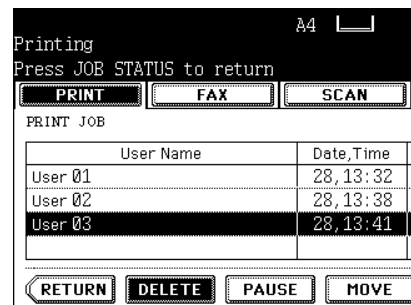

4 "Delete OK?" appears. Press the [DELETE] button to delete the job.



4. PRIVATE PRINT JOB

Private print enables to print the desired documents by entering the password which has been set on the application.

* For the Private print, see the [Print Guide].

Private Print

1 Press the [PRIVATE] button to display the private print job list.

2 Press the user name on the list you want to start with.

- If the relevant job is not displayed, press the [Next] or [Prev] button to switch the screen.

3 Press the [RELEASE] button.

4 Key in the password.

5 Press the [ENTER] button.

- The private print job is moved to the print job list to start printing.

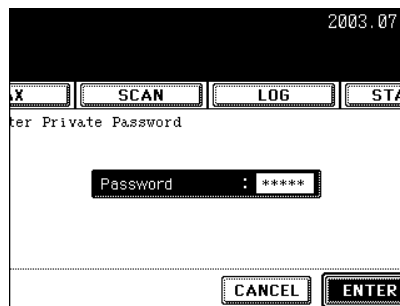
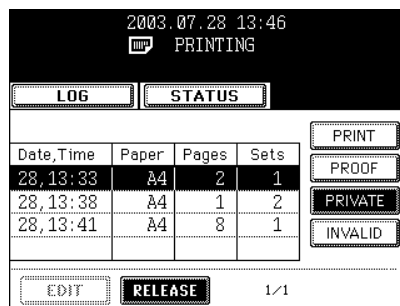

Deleting a Private Print

- 1 Press the [PRIVATE] button to display the private print job list.

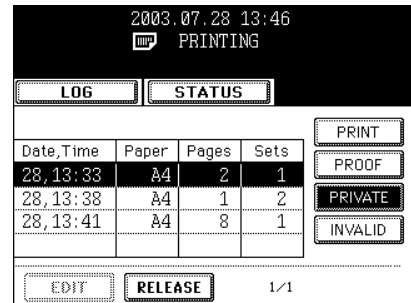

- 2 Press the user name on the list you want to delete.
- 3 Press the [DELETE] button.

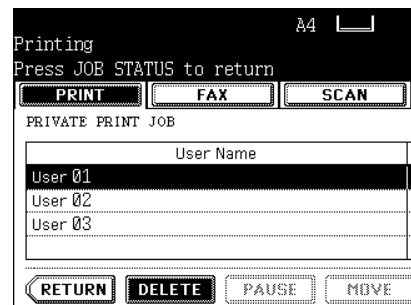

- 4 Key in the password.

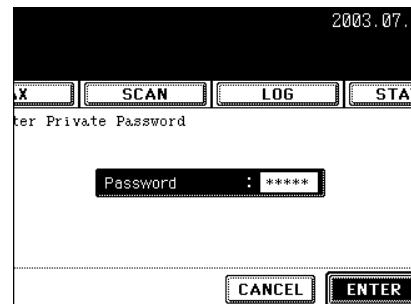

- 5 "Delete OK?" appears. Press the [DELETE] button to delete the job.



5. WHEN USING THE DEPARTMENT CODES

Jobs sent to the equipment without a Department Code or not a registered Department Code will appear in the Invalid Queue of Job status.

To Restore the Invalid Code (print error) to the Normal Print

1 Press the [INVALID] button to display the list.

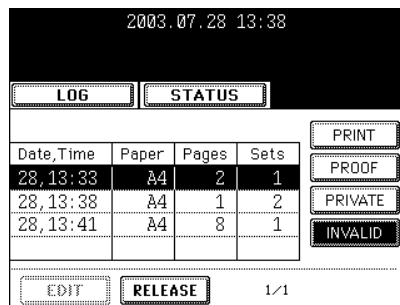

2 Press the user name on the list you want to print.

3 Press the [RELEASE] button.

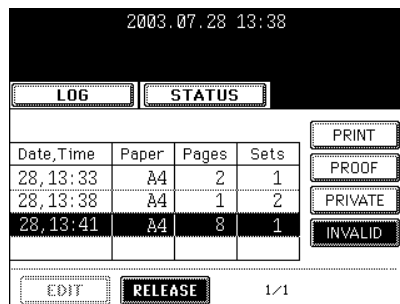

4 The department code entry screen is displayed. Key in the correct department code.

5 Press the [ENTER] button.

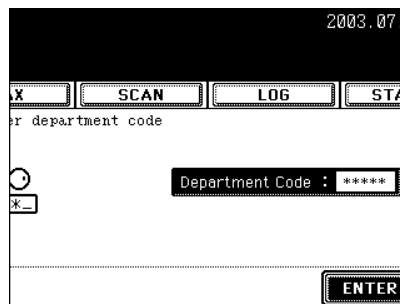

Deleting a Job from the List

- 1 Press the [INVALID] button to display the list.

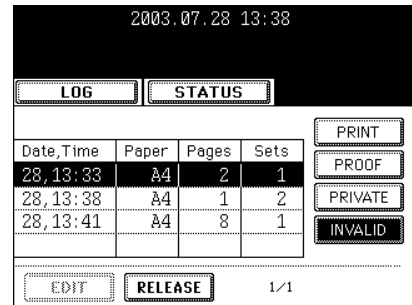

- 2 Press the user name on the list you want to delete.
- 3 Press the [DELETE] button.

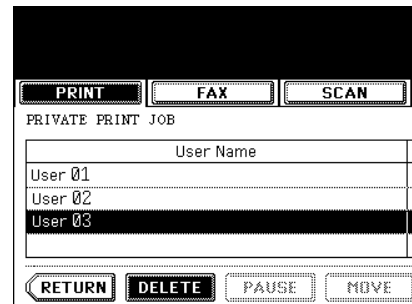

- 4 "Delete OK?" appears. Press the [DELETE] button to delete the job.



6. CONFIRMING THE STATUS OF FAX/INTERNET FAX JOB

Fax (optional)/Internet Fax JOB displays its status and enables to delete and send the job. 4 jobs are listed on each screen (page). The jobs for 250 pages (1,000 jobs) are available to display. Press the [Next] button to display the 5th job or later, and press the [Prev] button to display the previous page.

* For the Fax function, see the [Network Fax Guide].

2003.06.09 13:48

PRINT FAX SCAN LOG STATUS

Fax/InternetFAX JOB

File No.	To	Date,Time	Pages	Status

RETURN DELETE RESERVATION LIST RELEASE

1 / 1

- Items of list

File No.: Number of accepted job order

To: Recipient

Date, Time: Date and time at the time of registration

Pages: Number of pages to be sent

Status: Status of jobs or specified time for Delayed TX Reservation

- Buttons

[Delete]: The button becomes active when the deletable job is selected. When this button is pressed, the job is deleted.

* The [DELETE] button does not become active if Fax, Internet Fax, E-mail reception or print job on the list is selected.

[RESERVATION LIST]: To print the pending job list (including Delayed TX Reservation job), press this button.

[SEND]: The button becomes active when the job for Delayed TX Reservation (Fax only) is selected. To cancel the Delayed TX Reservation, press this button.

Tip

See the [Operator's Manual for Facsimile Function] for Delayed TX Reservation.

7. CONFIRMING THE STATUS OF SCAN

SCAN JOB displays its status and enables to delete the job. 4 jobs are listed on each screen. The jobs for 250 pages (1,000 jobs) are available to display. Press the [Next] button to display the 5th job or later, and press the [Prev] button to display the previous page.

* For the SCAN function, see the [SCANNING THE IMAGES]. "1.SCAN SETTING IN THE TOUCH PANEL"  Page 144

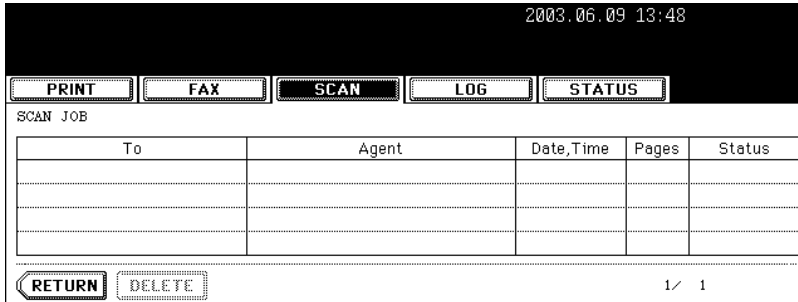

- Items of list

To: The storing location of the scanned data or Fax number of the sender

Agent: The job (Box, File or E-mail) to be executed in this function

Date, Time: Date and time at the time of registration

Pages: Number of pages of the originals

Status: Status of jobs

- Buttons

[Delete]: The button becomes active when the deletable job is selected. When this button is pressed, the job is deleted.

8. LOG LIST

LOG

LOG allows you to list the jobs that have finished being printed, sent/received Fax and scanned to confirm the results. You can also register the Fax number and E-mail address from the send/receive Fax and scan (*1) log to the address book.

*1 E-mail address used in the E-mail transmission

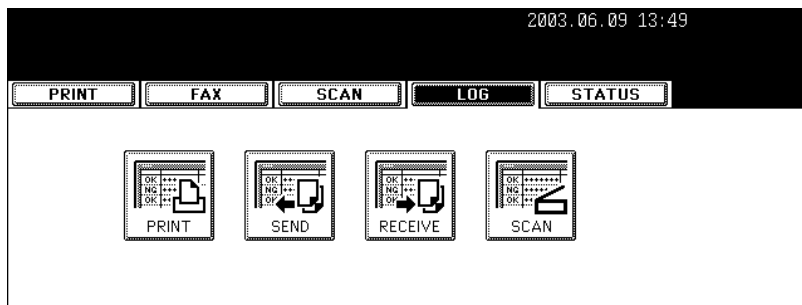

Print Log

When pressing the [PRINT] button on the log menu, the printing status is displayed.

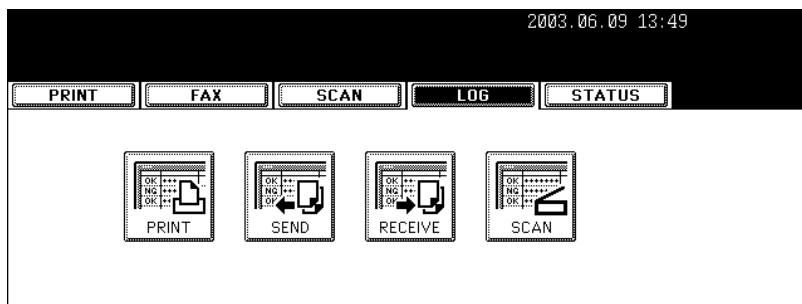

- Items of list

User Name: Sender's name

Date, Time: Date and time at the time of printing

Paper: Paper size

Pages: Number of pages

Sets: Number of sets

- Buttons

[Return]: To return to the log menu, press this button.

Send/Receive Log

When pressing the [SEND] or [RECEIVE] button on the log menu, the sending/receiving status of Fax or Internet Fax is displayed.

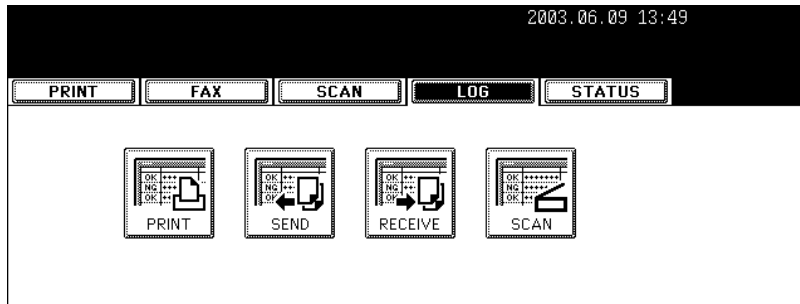

- Items of list

File No.: Number of accepted job order

To: Recipient's Fax number or recipient's E-mail address

From: Sender's Fax number or sender's E-mail address

Date, Time: Date and time at the time of sending or receiving Fax or Internet Fax

Pages: Number of pages of sent or received Fax or Internet Fax

Status: Status of job displayed with 'OK' or 'Error code' "12.ERROR CODE" Page 204

- Buttons

[JOURNAL]: To print the sending/receiving status, press this button. See "10.PRINTING SEND/RECEIVE LOG LIST OF FAX" Page 201 for details.

[ENTRY]: To register the Fax number or E-mail address in the sending/receiving status to the address book, press this button. See "9.ADDRESS REGISTRATION FROM LOG LISTS" Page 199 for details.

[RETURN]: To return to the log menu, press this button.

Scan Log

When pressing the [SCAN] button on the log menu, the scanning status is displayed.

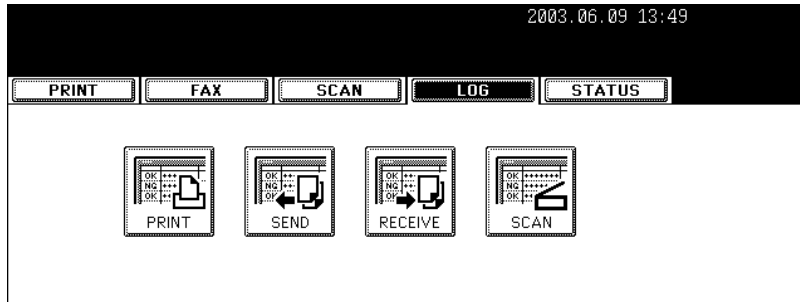

- Items of list

To: The storing location of the scanned data or E-mail address of the recipient

Agent: Scanned job in the scan menu

Date, Time: Date and time at the time of scanning

Pages: Number of pages scanned or sent E-mail

Status: Status of job displayed with 'OK' or 'Error code' "12.ERROR CODE" Page 204

- Buttons

[ENTRY]: To register the Fax number or E-mail address in the scanning status to the address book, press this button. See "9.ADDRESS REGISTRATION FROM LOG LISTS" Page 199 for details.

[RETURN]: To return to the log menu, press this button.

9. ADDRESS REGISTRATION FROM LOG LISTS

You can register the recipient (or sender) in the address book from the SEND /RECEIVE LOG list or the SCAN LOG list by selecting the recipient (or sender) and pressing the [ENTRY] button.

* For the address book, see the [User Function Guide].

- 1 Press the [LOG] button and then press the [SEND] (or [RECEIVE]) button.

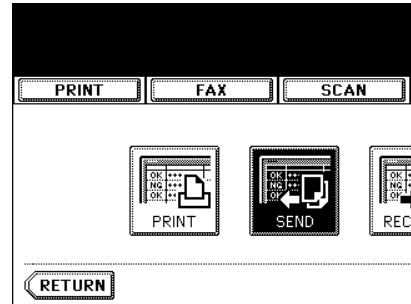

- 2 SEND LOG list (or RECEIVE LOG list) is displayed.

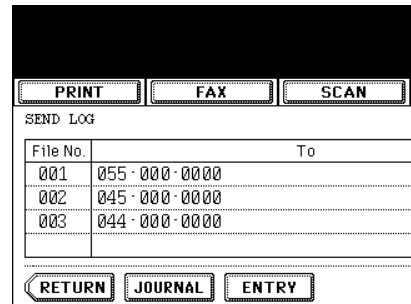

- 3 Select the recipient (or sender) you want to register in the address book.

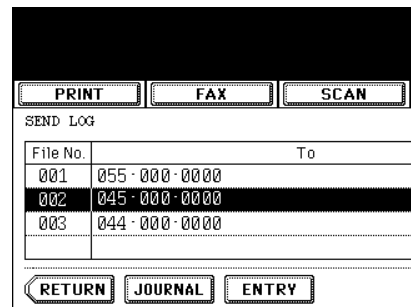

4 Press the [ENTRY] button.

SEND LOG		
File No.	To	
001	055-000-0000	
002	045-000-0000	
003	044-000-0000	

Buttons: PRINT, FAX, SCAN, RETURN, JOURNAL, ENTRY

5 ADDRESS ENTRY screen is displayed. Press the [NAME] button to enter the recipient's name.

- Entering letters "3.Entering letters" Page 141

6 Press the [ENTER] button.

2003.07.

Buttons: X, SCAN, LOG, STA

0. : 0004

E-MAIL : 045-000-0000

NAME : xxxxxx

Buttons: CANCEL, ENTER

10. PRINTING SEND/RECEIVE LOG LIST OF FAX

Up to 120 logs (3 pages) and 1 selected SEND (or RECEIVE) LOG are available to print in the SEND/RECEIVE LOG list of Fax.

* Either 40 logs (1 page) or 120 logs (3 pages) can be set to print the log list. See the [User Function Guide] for details.

- 1 Press the [LOG] button, and then press the [SEND] (or [RECEIVE]) button.

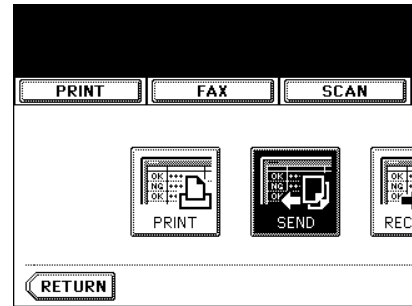

- 2 Press the [JOURNAL] button to print the SEND/RECEIVE LOG.

Tip

When 1 transmission (reception) is printed, press the recipient (or sender) on the list, and then press the [JOURNAL] button.

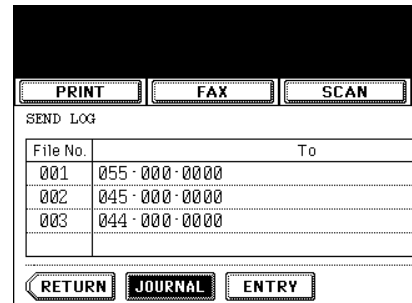

11. STATUS

STATUS displays the drawer's size of the equipment and highlights the active drawer during printing. When pressing the [STATUS] during stopping of the print job due to an error, the drawer's size and the active drawer can be changed in case of paper shortage and no applicable drawer.

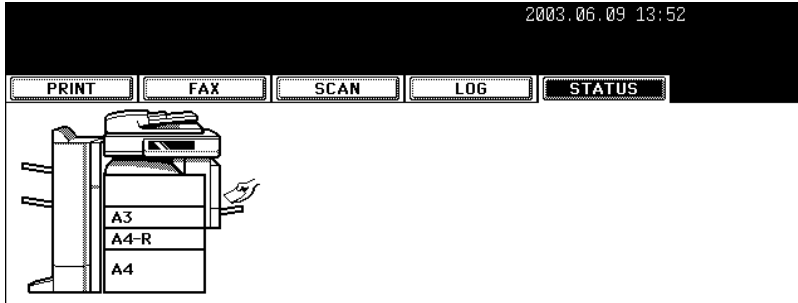



Releasing the Print Error

When the drawer for the specified size paper is not prepared, the print job error occurs and the [JOB STATUS] button blinks. To release the error, follow the procedure below.

1 Press the blinking [JOB STATUS] button.

2 Select the drawer to be changed.

- To select the drawer, press the drawer, or the  or  button on the screen.

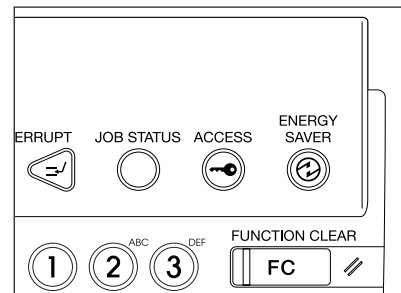

3 Change the paper size of the drawer to the specified size.

- Changing the paper size of the drawer "Changing the Paper Size of the Drawer/Setting the Drawer for Special Uses"  Page 38

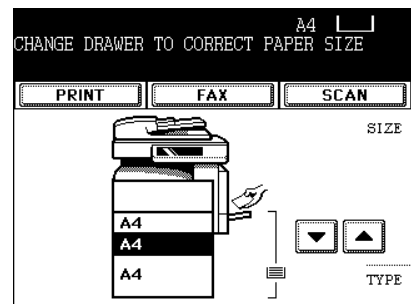

4 Press the paper size button you set by pressing the paper size button on the screen.

5 Press the [START] button.

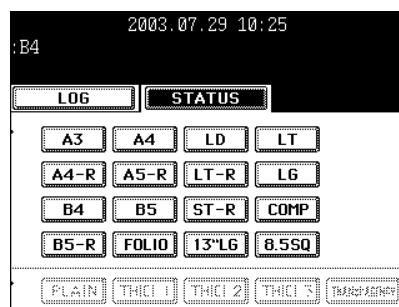

12. ERROR CODE

If an error occurs while using the Fax (including the Internet Fax) or scan, the error code is displayed in the status of each log. Take an appropriate action with reference to the following.

Fax/Internet Fax

Error Code	Cause	Corrective Action
Fax		
0011	Paper jam	Clear the jammed printing paper.
0012	Original jam	Clear the jammed original.
0013	Door open	Firmly close the open door.
0020	Power interruption	Check the power interruption report.
0030	Reset	(The transmission was canceled by pressing the [FUNCTION CLEAR] button.)
0033	Polling Error	Check polling options setup (Security Code, etc.), and check if the polling document exists.
0042	Memory full	Make sure that there is sufficient memory before making the call again.
0050	Line busy	Retry communications.
0053	Security Mismatch in Relay or Mail Box transmission	Confirm the remote party's Security Code, system password, and your setup.
00B0-00E8	Communications error	Retry communications.
Internet Fax		
1C10	System access abnormality	Turn the power OFF and then back ON. Perform the job in error again. If the error still occurs, contact your authorized dealer for support.
1C11	Insufficient memory	When there are running jobs, perform the job in error again after the completion of the running jobs. If the error still occurs, turn the power OFF and then back ON, and perform the job again.
1C12	Message reception error	Turn the power OFF and then back ON. Perform the job in error again.
1C13	Message transmission error	Turn the power OFF and then back ON. Perform the job in error again.
1C14	Invalid parameter	When a template is used, form the template again. If the error still occurs, turn the power OFF and then back ON, and perform the job again.

Error Code	Cause	Corrective Action
1C15	Exceeding file capacity	Ask your administrator to change the "Fragment Page Size" setting for the Internet Fax setting, or reduce the number of pages and perform the job again.
1C20	System management module access abnormality	Turn the power OFF and then back ON. Perform the job in error again. If the recovery is still not completed, contact your authorized dealer for support.
1C21-1C22	Job control module access abnormality	Turn the power OFF and then back ON. Perform the job in error again. If the recovery is still not completed, contact your authorized dealer for support.
1C30	Directory creation failure	Check if the access privilege to the storage directory is writable. Check if the server or local disc has a sufficient space in disc capacity.
1C31	File creation failure	Check if the access privilege to the storage directory is writable. Check if the server or local disc has a sufficient space in disc capacity.
1C32	File deletion failure	Turn the power OFF and then back ON. Perform the job in error again. If the error still occurs, contact your authorized dealer for support.
1C33	File access failure	Check if the access privilege to the storage directory is writable. Check if the server or local disc has a sufficient space in disc capacity.
1C40	Image conversion abnormality	Turn the power OFF and then back ON. Perform the job in error again. If the error still occurs, contact your authorized dealer for support.
1C60	HDD full failure during processing	Reduce the number of pages of the job in error and perform the job again. Check if the server or local disc has a sufficient space in disc capacity.
1C61	Address Book reading failure	Turn the power OFF and then back ON. Perform the job in error again. Reset the data in the Address Book and perform the job again. If the error still occurs, contact your authorized dealer for support.

Error Code	Cause	Corrective Action
1C62	Memory acquiring failure	Turn the power OFF and then back ON. Perform the job in error again. If the error still occurs, contact your authorized dealer for support.
1C63	Terminal IP address unset	Ask your administrator to set the IP address of the equipment.
1C64	Terminal mail address unset	Ask your administrator to set the E-mail address of the equipment.
1C65	SMTP address unset	Ask your administrator to set the SMTP server address.
1C66	Server time time-out error	Check if the SMTP server is operating properly.
1C67	NIC time time-out error	Turn the power OFF and then back ON. Perform the job in error again. If the error still occurs, contact your authorized dealer for support.
1C68	NIC access error	Turn the power OFF and then back ON. Perform the job in error again. If the error still occurs, contact your authorized dealer for support.
1C69	SMTP server connection error	Ask your administrator to set the login name or password of SMTP server and perform the job again. Check if the SMTP server is operating properly.
1C6A	HOST NAME error	Ask your administrator to check if there is an illegal character in the device name. Delete the illegal character and reset the appropriate device name.
1C6B	Terminal mail address error	Ask your administrator to check if there is an illegal character in the E-mail address of the equipment. Delete the illegal character and reset the appropriate E-mail address, then perform the job again.
1C6C	Destination mail address error	Check if there is an illegal character in the Destination E-mail address. Delete the illegal character and reset the appropriate Destination E-mail address, then perform the job again.
1C6D	System error	Turn the power OFF and then back ON. Perform the job in error again. If the error still occurs, contact your authorized dealer for support.

Error Code	Cause	Corrective Action
1C70	SMTP client OFF	Ask your administrator to enable the SMTP Client and perform the job again.
1C80	Internet Fax transmission failure when processing E-mail job received	Confirm the "Received Internet Fax Forward" settings.
1C81	Onramp Gateway transmission failure	Confirm the mail box settings.
1C82	Internet Fax transmission failure when processing Fax job received	Confirm the "Received Fax Forward" setting.
1CC1	Power failure	Check if the power cable is connected properly and it is inserted securely. Check if the power voltage is unstable.

Scan Job

Error Code	Message	Corrective Action
SCAN TO E-MAIL		
2C10, 2C12, 2C13, 2C20-2C22	Illegal Job status	A system error has occurred during sending an E-mail. Retry it.
2C11, 2C62	Not enough memory	Make sure there is enough memory to send the scan job.
2C14	Invalid parameter specified	Make sure you specify the settings correctly and try again.
2C15	Message size exceeded limit or maximum size	You are sending too many documents at a time. Send your documents separately.
2C30	Failed to create directory	Retry the scan. The system could not send the scan job.
2C31, 2C33	Failed to create file	Retry the scan. The system could not send the scan job.
2C32	Failed to delete file	Retry the scan. The system could not send the scan job.
2C40	Failed to convert image file format	Retry the scan. The system could not send the scan job.
2C61	Failed to read AddressBook	Retry the scan. The system could not send the scan job.
2C63, 2C64	Invalid Domain Address	Make sure you are sending to right E-mail address and retry the scan.
2C65, 2C66, 2C69	Failed to connect to SMTP server	Make sure the SMTP server is correctly working, or the SMTP server address has been set correctly. Then retry the scan.

Error Code	Message	Corrective Action
2C67, 2C68 2C6A	Failed to send E-Mail message	Retry the scan. NIC time out error occurs during the transmission.
2C6B	Invalid address specified in From: field	Make sure you specify correct E-mail address for this equipment and retry the scan.
2C6C	Invalid address specified in To: field	Make sure you are sending to correct E-mail addresses and retry the scan.
2C6D	NIC system error	Contact your dealer for support.
2C70	SMTP service is not available	Ask your administrator whether the SMTP service is enabled.
2C80	Failed to process received E-mail job	Make sure the network cable is connected properly.
2C81	Failed to process received Fax job	Make sure the telephone line is connected properly.
2CC0	Job canceled	Job was canceled.
2CC1	Power failure occurred	Power failure occurred during the transmission.
Save as file		
2D10, 2D12, 2D13, 2D20-2D22	Illegal Job status	A system error has occurred during storing a file. Retry it.
2D11	Not enough memory	Make sure there are enough memory to save the scan job.
2D14, 2D61	Invalid parameter specified	Make sure you specify the settings correctly and try again.
2D15, 2D65	There are too many documents in the folder. Failed in creating new document.	Delete the data in the local shared folder in the equipment and retry the scan.
2D30	Failed to create directory	Retry the scan. The system could not save the scan job.
2D31, 2D33	Failed to create file	Retry the scan. The system could not save the scan job.
2D32	Failed to delete file	Retry the scan. The system could not save the scan job.
2D40	Failed to convert image file format	Retry the scan. The system could not save the scan job.
2D60	Failed to copy file	Retry the scan. The system could not save the scan job.
2D62	Failed to connect to network destination. Check destination path.	Make sure the network folder is shared in your network and retry the scan.

Error Code	Message	Corrective Action
2D63	Specified network path is invalid. Check destination path.	Make sure you specify correct network folder and retry the scan.
2D64	Logon to file server failed. Check username and password.	Make sure you specify correct user name and password to logon the file server and retry the scan.
2D66	Failed to process your job. Insufficient disc space.	Delete the data in the local shared folder in the equipment and retry the scan.
2D67	FTP service is not available.	Ask your administrator whether the FTP service is configured correctly.
2D68	File Sharing service is not available.	Ask your administrator whether the SMB protocol is enabled.
2DC0	Job canceled	Job was canceled.
2DC1	Power failure occurred	Power failure occurred during the process.
Store to e-Filing		
2B10	There was no applicable job.	Retry the scan.
2B11	Job status failed.	Retry the scan. The system could not store the scan job.
2B20	Failed to access file.	Retry the scan. The system could not store the scan job.
2B30	Insufficient disc space.	Delete unnecessary documents in e-Filing and try again.
2B31	Failed to access Electronic Filing.	The selected box or folder does not exist, or is being created or deleted. Make sure the destination box or folder and retry again.
2B32	Failed to print Electronic Filing document.	The selected document is being used by another user. Retry later.
2B50	Failed to process image.	Retry the scan. The system could not store the scan job.
2B51	Failed to process print image.	Perform printing again.
2B60	Duplicate error. Changed folder name automatically.	There is the same named folder in the selected box. The system automatically renames the folder.
2B70	Duplicate error. Changed document name automatically.	There is the same named document in the selected box or folder. The system automatically renames the document.
2B90	Insufficient Memory.	Retry the scan. The system could not store the scan job.
2BA0	Invalid Box password specified.	The specified box password is incorrect. Correct the agent setting and try again.

Error Code	Message	Corrective Action
2BB0	Job canceled	Job was canceled.
2BB1	Power failure occurred	Power failure occurred during the process.
2BC0	System fatal error.	The system error occurs during the process. Retry the scan.
2BC1	Failed to acquire resource.	Retry the scan. The system could not store the scan job.

10. e-FILING

1. e-FILING FUNCTIONS	212
2. SETTING UP BOX.....	214
3. CHANGING INPUT DATA.....	216
4. DELETING BOX	218
5. PRINTING STORED DOCUMENT	219

1. e-FILING FUNCTIONS

In this e-Filing functions, the documents obtained by copying, scanning, printing, Fax receiving (when an option is installed), Internet Fax and E-mail reception can be managed in the e-Filing (hard disc) inside the equipment. Before you use the e-Filing, you need to set up it. The e-Filing consists of one public box and user boxes up to 200. You can store a number of documents in each box, and then print the stored documents later as required.

- e-filing can be operated with the equipment or a client PC via network. For the operation via network, see the [e-Filing Guide].

* If the preservation period for documents is specified for a user box in the e-Filing web utility, the stored documents will be deleted after that period has passed. Before that, you need to print the documents, or download them with a client PC using the File Downloader. See the [e-Filing Guide] for details.

* The hard disc could be at fault. Be sure to backup the stored documents by downloading them with a client PC using the File Downloader. See the [e-Filing Guide] for details.

The following figure shows the functional diagram of the e-Filing.



1 : Store the document.

2 : Add the printing settings to the stored documents as required.

3 : Print the documents.

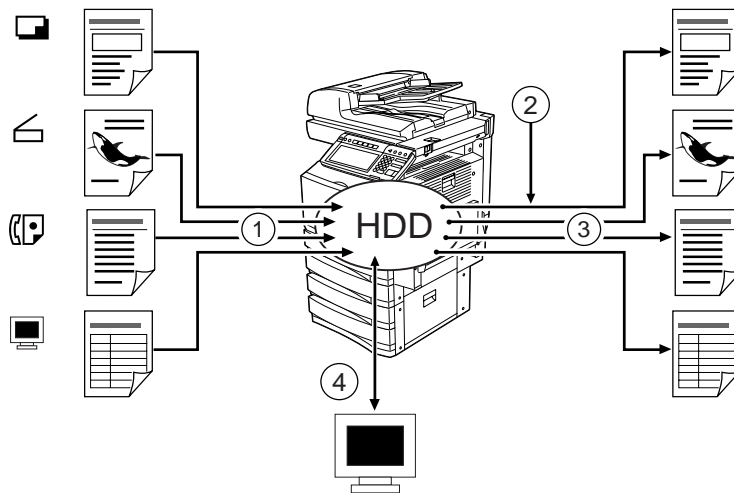
4 : The documents can be viewed, edited, merged (Copy/Paste), and printed by the e-Filing web utility via network. Also, the documents can be downloaded by the File Downloader, and imported into TWAIN-compliant applications by the TWAIN driver. See the [e-Filing Guide] for details.



With the equipment, documents can be stored in the e-Filing as the original data by copying or scanning. ("1.STORE TO e-FILING"  Page 136, "2.SCAN TO e-FILING"  Page 147) The documents stored in the e-Filing can be printed by specifying some pages or "All Pages" after adding/changing printing settings as required. Also, unnecessary documents can be deleted from the specified user box.

The following table shows the main difference between the operation by the equipment and that by a client PC using the e-Filing web utility via network.

Function	Equipment (Touch Panel)	Client PC
Creating the user box	Yes	Yes
Creating the folder in the user box	No	Yes
Deleting the user box	Yes	Yes
Deleting the folder or document in the user box	No	Yes
Editing the documents (combining, switching, etc.)	No	Yes

The following shows the basic configuration of the e-Filing.

Public box	Shared document 1, Shared document 2, ...	
User box 001	Document 1	
	Document 2	
	Folder 1	Document 1
		Document 2

The public box is a pre-set box by default in the equipment. Use it to store documents that any user may need to work with. Up to 200 user boxes can be registered. It can be registered as a password-protected user box by setting the password. Before storing documents in e-Filing, prepare the user boxes to manage documents efficiently.

- Up to 200 folders per one box can be created (can only be set via the network). See the [e-Filing Guide] for details.
- Up to 1,000 documents can be stored in a box or a folder. The Maximum page number of a document is 1,000.

2. SETTING UP BOX

The e-Filing consists of one public box and user boxes up to 200. The public box is a pre-set box since the installation of the equipment, and no setting up is required. The user box can be set/registered by giving a box name. If the password is set, the box is protected and important documents can be stored safely. Up to 200 user boxes can be set/registered.

* Before storing documents in the e-Filing, we recommend you to prepare user boxes and folders (can only be set in the network) to manage documents efficiently. See the [e-Filing Guide] for details.

1 Press the [e-FILING] button on the control panel.

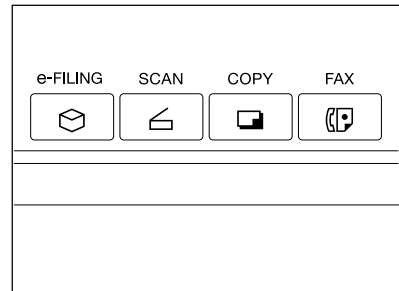

2 Select the blank buttons numbered from 001 to 200, and then press the [SETUP] button.

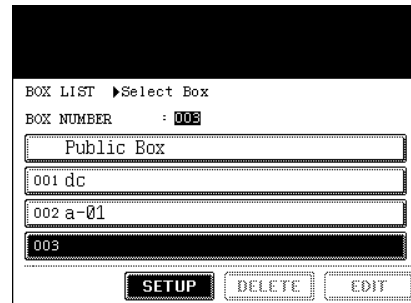

3 Set the "BOX NAME". Then, set the "Password" as required.

- When pressing the [BOX NAME] button, the letter entry menu ("3. ENTERING LETTERS" Page 141) is displayed. A box name can contain up to 32 letters. If the "BOX NAME" is not set, the box name will be "New Box".
- Key in the 5-digit identical number in both "Password" and "Retype Password". Press the [SET] button after entering the password.

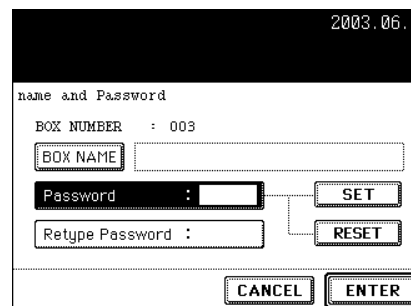

4 Press the [ENTER] button.

- A box is newly set.

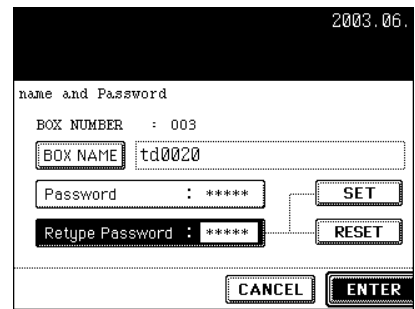

2003.06.

name and Password

BOX NUMBER : 003

BOX NAME : td0020

Password : *****

Retype Password : *****

SET

RESET

CANCEL

ENTER

3. CHANGING INPUT DATA

The “registered box name” and “password” of the user box can be changed.

* You cannot change the folder name with the equipment. Change it with a client PC using the e-Filing web utility via network, if required. See the [e-Filing Guide] for details.

1 Press the [e-FILING] button on the control panel.

2 Select the box you want to change, and then press the [EDIT] button.

- Switch to the applicable menu using the [Prev] or the [Next] button.
- To display the applicable menu immediately, key in the number of the desired box you want to change.

BOX LIST ▶ Select Box
BOX NUMBER : 003
Public Box
001 dc
002 a-01
003 td-0020
SETUP DELETE EDIT

3 Key in the “Password” (5 digits) for the selected box, and then press the [ENTER] button.

- If the password has not been set at the box registration, skip to step 4.

2003.06.
Password
BOX NUMBER : 003
BOX NAME : td-0020
Password : *****
CANCEL ENTER

4 Change the data of the “BOX NAME” and the “Password”.

- When pressing the [BOX NAME] button, the letter entry menu (“3. ENTERING LETTERS” Page 141) is displayed. A box name can contain up to 32 letters.
- Key in the 5-digit identical number in both “Password” and “Retype Password”. Press the [SET] button after entering the password.

2003.06.
Name and Password
BOX NUMBER : 003
BOX NAME : td-0222
Password : ***** SET
Retype Password : ***** RESET
CANCEL ENTER

5 Press the [ENTER] button.

- The box settings are updated.

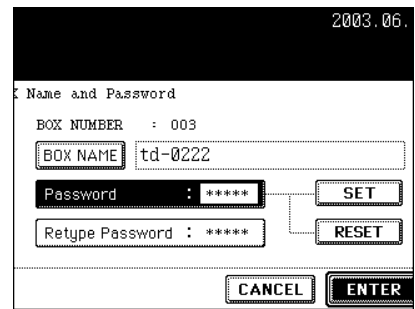

2003.06.

Name and Password

BOX NUMBER : 003

BOX NAME : td-0222

Password : *****

Retype Password : *****

SET

RESET

CANCEL

ENTER

4. DELETING BOX

The unnecessary user box can be deleted. In this case, all the documents in a user box are also deleted.

- * The public box cannot be deleted.
- * You cannot delete the folder in a user box with the equipment. Delete it with a client PC using the e-Filing web utility via network, if required. See the [e-Filing Guide] for details.

1 Press the [e-FILING] button on the control panel.

2 Select the box you want to delete, and then press the [DELETE] button.

- Switch to the applicable menu using the [Prev] or the [Next] button.
- To display the applicable menu immediately, key in the number of the desired box you want to change.

BOX LIST ▶ Select Box
BOX NUMBER : 003
Public Box
001 dc
002 a-01
003 td-0020
SETUP DELETE EDIT

3 Key in the “Password” (5 digits) for the selected box, and then press the [ENTER] button.

- If the password has not been set at the box registration, skip to step 4.

2003.06.
Password
BOX NUMBER : 003
BOX NAME : td-0020
Password : *****
CANCEL ENTER

4 “Are you sure you want to delete this BOX?” appears. Press the [YES] button to delete the box.

- The selected box is deleted.

2003.06.
Are you sure you want to delete this
YES NO

5. PRINTING STORED DOCUMENT

Documents stored in the box or the folder can be printed.

State of finishing can be selected. And to confirm the printing content, test printing can also be performed.

Print the whole Document.

All the pages of the document will be printed. If printing multiple copies is desired, see "Printing the Stored Document with Added/Changed Settings"  Page 221.

1 Press the [e-FILING] button on the control panel.

2 Select the box which has the desired printing document stored, and then press the [ENTER] button.

- Switch to the applicable menu using the [Prev] or the [Next] button.
- To display the applicable menu immediately, key in the number of the desired box you want to change.

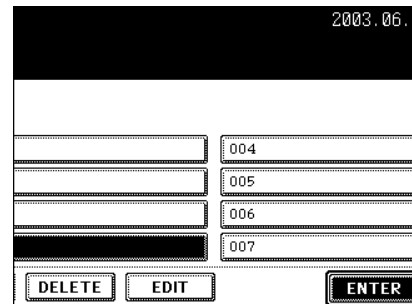

2003.06.

	004
	005
	006
	007

DELETE EDIT ENTER

3 Key in the "Password" (5 digits) for the selected box, and then press the [ENTER] button.

- If the password has not been set at the box registration, skip to step 4.

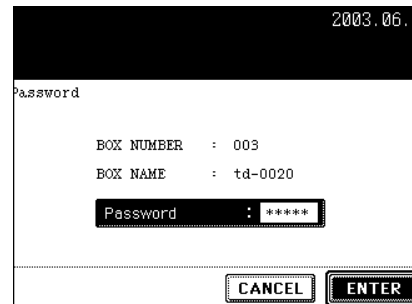

2003.06.

Password

BOX NUMBER : 003
BOX NAME : td-0020

Password : *****



CANCEL ENTER

4 Select the document to be printed.

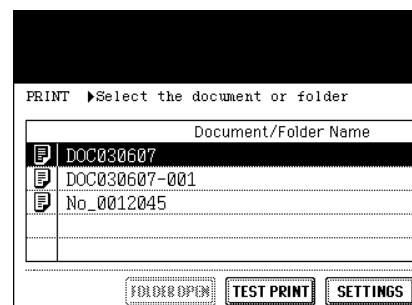
- When you want to select the document in the folder, select the folder and press the [OPEN FOLDER] button. And then select the desired document.



PRINT ▶ Select the document or folder

	Document/Folder Name
	DOC030607
	DOC030607-001
	No_0012045

FOLDER OPEN TEST PRINT SETTINGS

5 Press the [PRINT] button.

- Printing of the whole document starts.

2003.06.07 19:44

	Date,Time	Paper	Pages
	07,19:00	A4	1
	07,19:01	A4	1
	07,19:03	A4	1

CANCEL PRINT 1 / 1

Execute Test Printing

A part can be printed from a document that consists of several pages.

1 Perform steps 1 to 4 of the “Print the whole Document”.

2 Press the [TEST PRINT] button.

PRINT ▶ Select the document or folder

Document/Folder Name

	DOC030607
	DOC030607-001
	No_0012045

FOLDER OPEN TEST PRINT SETTINGS

3 Key in the number of the last page to specify the printing page.

- When printing all pages are desired, press the [ALL PAGES] button.

2003.06.

last page number

Printing Page : 1- 1

ALL PAGES

CANCEL PRINT

4 Press the [PRINT] button.

- Printing the set page starts.

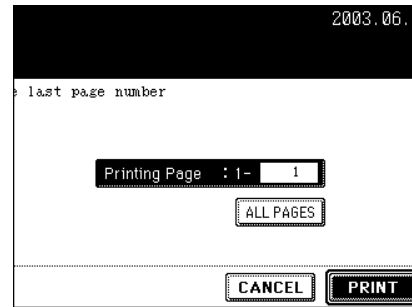

Printing the Stored Document with Added/Changed Settings

The following settings can be added (or changed) to the stored document in the filing box.

- 1: Setting the feeding source (Press the cassette area of the feeding source)
- 2: Setting the number of printing (Key in by the digital key)
- 3: Setting single-side printing/duplex printing.
- 4: Setting the finishing mode setting (Selection of the mode is limited depending on the installed option equipment)
- 5: Setting the paper exit (Can be set when an optional finisher is installed.)
- 6: Setting the image shift position
- 7: Setting the added date and time position
- 8: Setting of added page position

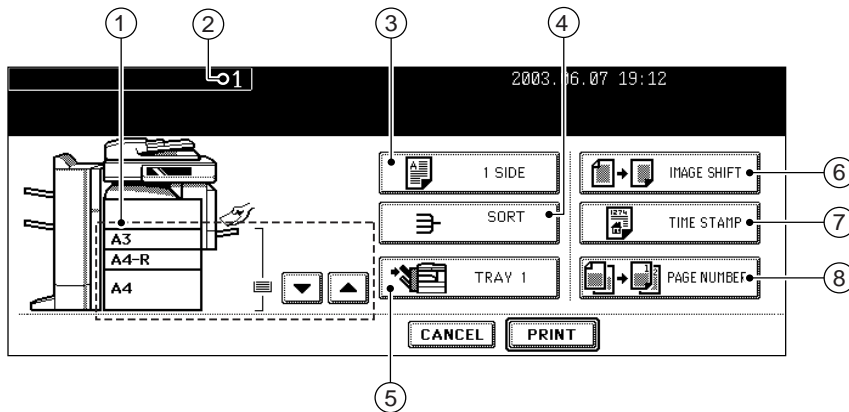

- 1 Perform steps 1 to 4 of the “Print the whole Document”.

2 Press the [SETTINGS] button.

3 Set printing as required.

- See the previous page for details. As for the settings of 3 to 8, press the button, select the desired button in the menu and press the [ENTER] button.

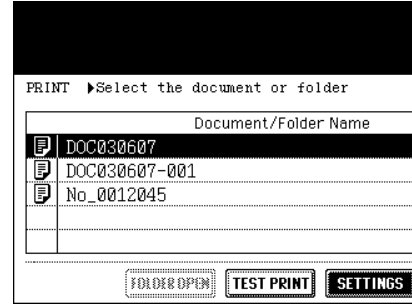

4 Press the [PRINT] button.

- Printing starts.

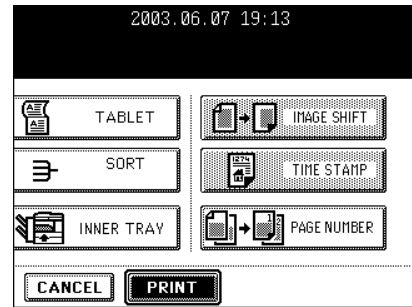

11. TEMPLATE

1. TEMPLATE	224
2. RECALLING TEMPLATE	225
3. REGISTERING TEMPLATE.....	228
4. CHANGING INPUT DATA.....	233
5. DELETING TEMPLATE	237

1. TEMPLATE

A combination of functions frequently used can be registered as a template and recalled as required

* You can register the setting combination of copy functions, scan functions or facsimile functions (optional) as a template and retrieve it.

The combinations are registered in either "PUBLIC TEMPLATE GROUP" or "USER GROUP (Up to 200 groups are available.)" in the menu of template. Up to 60 combinations can be registered in 1 group.

- 1 : Register the combination of the functions.
- 2 : Place the original.
- 3 : Retrieve the desired template.

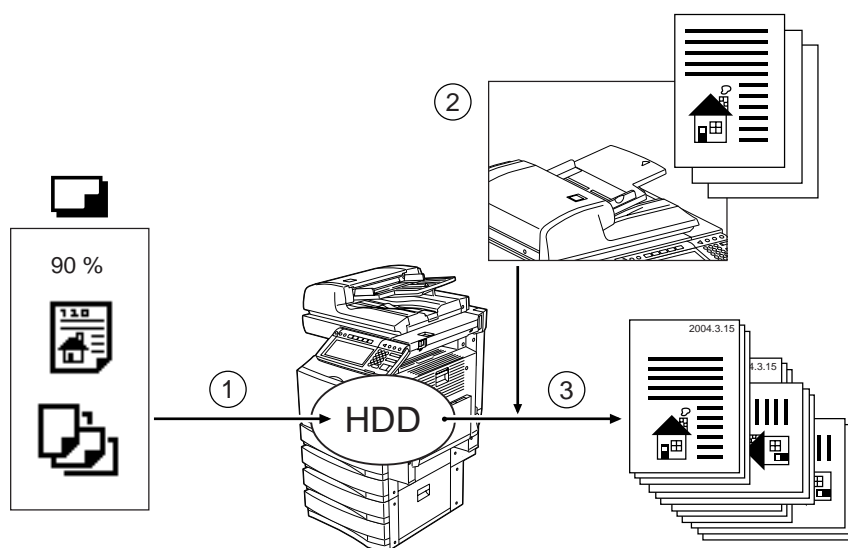

2. RECALLING TEMPLATE

All you have to do is to press the [START] button (the [SCAN] button on the touch panel for scanning) after recalling the required template.

When Recalling Template in the Public Group

1 Place paper in the drawer(s).

- "1.SETTING COPY PAPER"  Page 36

2 Place the original(s).

- "2.SETTING ORIGINALS"  Page 45

3 Press the [TEMPLATE] button on the control panel.

- Menu for recalling template is displayed.

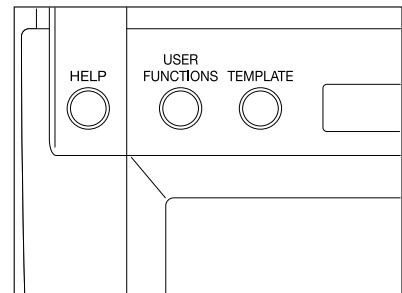

4 Select the [PUBLIC TEMPLATE GROUP] button, and then press the [ENTER] button.

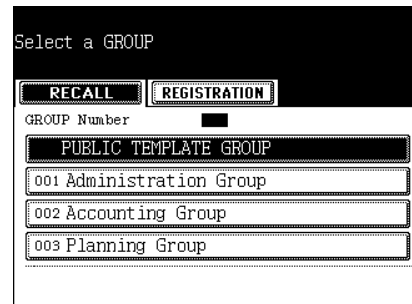

5 Select the desired template.

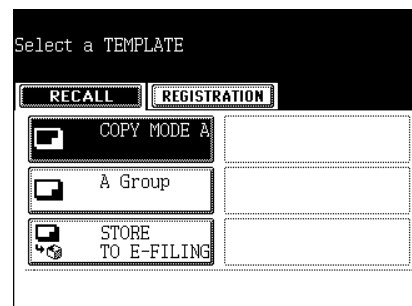

6 Confirm that “Updated the template setting” is displayed on the screen.

- Select other copy mode as required.

7 Press the [START] button.

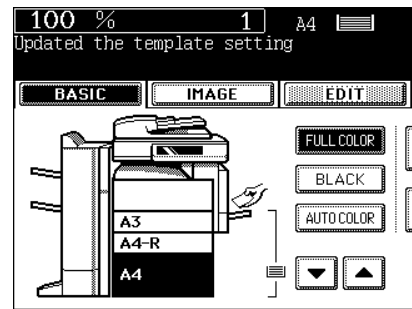

When Recalling Template in the User Group

1 Place paper in the drawer(s).

- "1.SETTING COPY PAPER" Page 36

2 Place the original(s).

- "2.SETTING ORIGINALS" Page 45

3 Press the [TEMPLATE] button on the control panel.

- Menu for recalling template is displayed.

4 Select the group registered the template you want to recall, and then press the [ENTER] button.

- Switch to the applicable menu using the [Prev] or the [Next] button.
- To display the applicable menu immediately, key in the number of the desired user group.

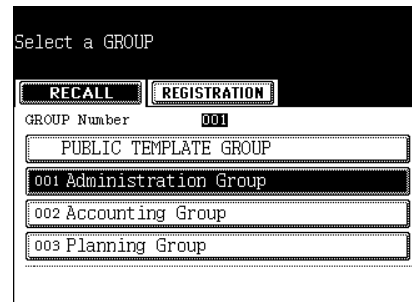

5 Key in the Password (5 digits) of the selected group, and then press the [ENTER] button.

- If the password has not been set at the group registration, skip this procedure and go to step 6.

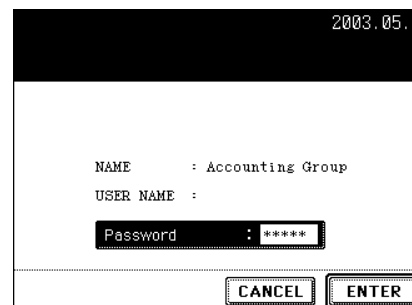

6 Select the desired template.

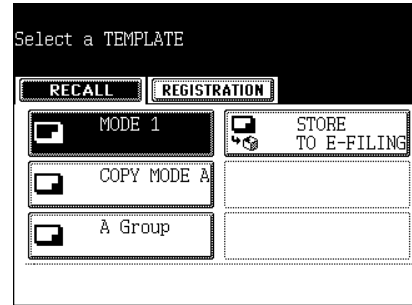

7 Key in the Password (5 digits) of the selected template, and then press the [ENTER] button.

- If the password has not been set at the group registration, skip this procedure and go to step 8.

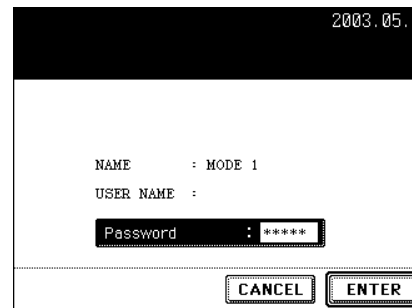

8 Confirm that “Updated the template setting” is displayed on the screen.

- Select other copy mode as required.

9 Press the [START] button.

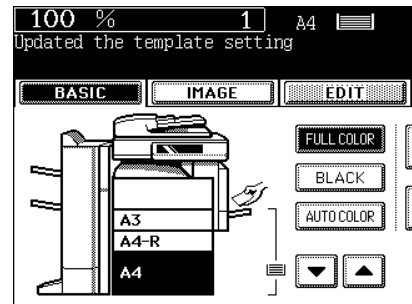

3. REGISTERING TEMPLATE

To recall the template, you need to first register the setting combination as a template.

The template is registered either in "PUBLIC TEMPLATE GROUP" or "USER GROUP" depending on your purpose.

- PUBLIC TEMPLATE GROUP:

Anyone can use the template when the setting combination of the functions frequently used throughout the company or organization have been registered in this group. Up to 60 combinations (templates) are available in this group. According to the purpose of use, you can restrict the use by entering the password.

- USER GROUP:

Each department, section or person controls one user group and registers it as a template. It is easier to control it if you set the password for group registration. Up to 200 groups can be set and up to 60 combinations (templates) are available in this group.

* When registering the template in the public template group, keying in the "Admin Password" is required.

Registering the Template in the Public Template Group

1 Set every function you want to combine.

- Ex.: Setting "Image shift", "90% Reduction" and "10 sets of copies" of the copy function.

2 Press the [TEMPLATE] button on the control panel.

3 Press the [REGISTRATION] button.

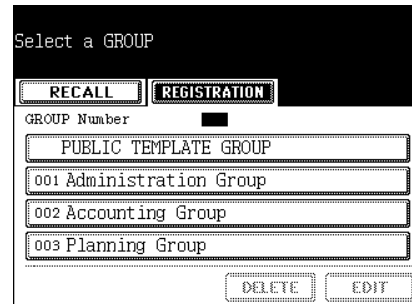

4 Select "PUBLIC TEMPLATE GROUP", and then press the [ENTER] button.

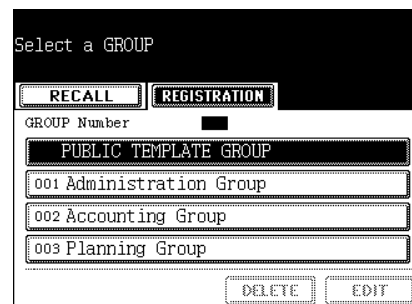

5 Key in the “Admin Password” (6 digits), and then press the [ENTER] button.

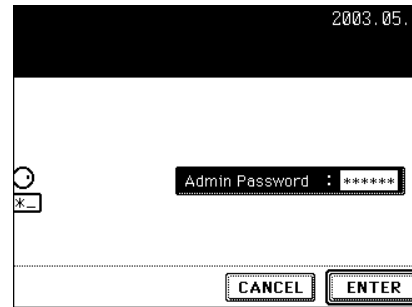

6 Press the blank key in the template menu, and then press the [SAVE] button.

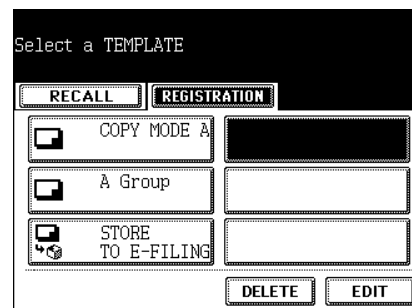

7 Enter the data for registering template.

- Although either the “NAME 1” or the “NAME 2” must be entered, the “USER NAME” and the “PASSWORD” are entered as required.
- When pressing the [NAME 1] button, the menu of entering letters (“3. ENTERING LETTERS” Page 141) is displayed, so enter the name with up to 11 letters.
- Enter the name with up to 11 letters for “NAME 2” and with up to 30 letters for “USER NAME” as the above manner.

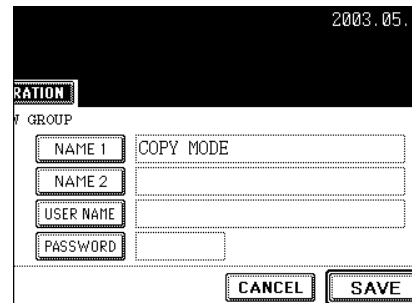

8 When pressing the [PASSWORD] button on the menu of step 7, the menu is switched as shown on the right. Key in 5-digit identical number in both “Password” and “Retype Password”, and then press the [ENTER] button.

- Press the [ENTER] button after entering the password.

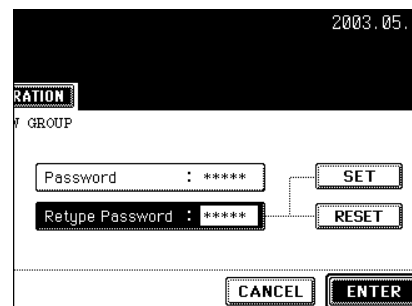

9 Press the [SAVE] button.

- The menu returns to step 1. (the menu before pressing the [TEMPLATE] button on the control panel.)

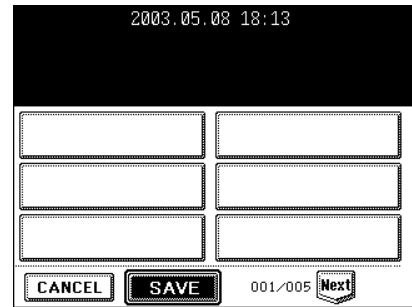

Registering the Template in the User Group

1 Set every function you want to combine.

- Ex: Setting "Image shift", "90% Reduction" and "10 sets of copies" of the copy function.

2 Press the [TEMPLATE] button on the control panel.

3 Press the [REGISTRATION] button.

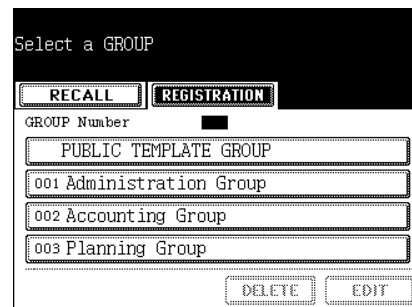

4 Select the "USER GROUP" of blank buttons from 001 to 200, and then press the [ENTER] button.

- When selecting the unregistered "USER GROUP", follow step 5.

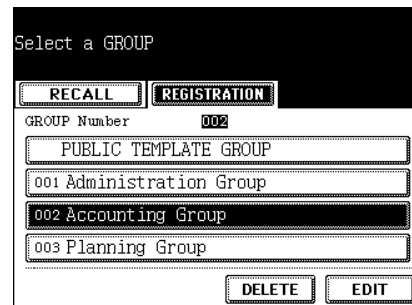

- When selecting the registered "USER GROUP", key in "GROUP PASSWORD" (5 digits) on the next menu, and then skip to step 8.

2003.05.

NAME : Accounting Group
 USER NAME :
 Password : *****

CANCEL ENTER

5 Enter the data for registering the new user group.

- Although the "NAME" must be entered, the "USER NAME" and the "PASSWORD" are entered as required.
- When pressing the [NAME] button, the menu of entering letters ("3. ENTERING LETTERS" Page 141) is displayed, so enter the name with up to 20 letters.
- Enter the name with up to 30 letters for the [USER NAME] as the above manner.

2003.05.

RATION
 GROUP

NAME NEW GROUP
 USER NAME
 PASSWORD

CANCEL ENTER

6 When pressing the [PASSWORD] button on the menu of step 5, the menu is switched as shown on the right. Key in a 5-digit identical number in both "Password" and "Retype Password", and then press the [ENTER] button.

- Press the [ENTER] button after entering the password.

2003.05.

RATION
 GROUP

Password : ***** SET
 Retype Password : RESET

CANCEL ENTER

7 Press the [ENTER] button.

2003.05.

RATION
 counting Group

Password : ***** SET
 Retype Password : ***** RESET

CANCEL ENTER

8 Press the empty [TEMPLATE] button, and then press the [SAVE] button.

9 Enter the data requested.

- Although either the "NAME 1" or the "NAME 2" must be entered, the "USER NAME" and the "PASSWORD" are entered as required.
- When pressing the [NAME 1] button, the menu of entering letters ("3. ENTERING LETTERS" Page 141) is displayed, so enter the name with up to 11 letters.
- Enter the name with up to 11 letters for "NAME 2" and with up to 30 letters for "USER NAME" as the above manner.

10 When pressing the [PASSWORD] button on the menu of step 9, the menu is switched as shown on the right. Key in a 5-digit identical number in both "Password" and "Retype Password", and then press the [ENTER] button.

- Press the [ENTER] button after entering the password.

11

11 Press the [SAVE] button.

- The menu returns to step 1, which is the menu seen before pressing the [TEMPLATE] button on the control panel.

4. CHANGING INPUT DATA

The registered name, user name, password of template/user group can be changed.

Changing the Data of Template

1 Press the [TEMPLATE] button on the control panel.

2 Press the [REGISTRATION] button

3 Select the group (in which the template was registered) that you want to change, and then press the [ENTER] button.

- Switch to the applicable menu using the [Prev] or the [Next] button.
- To display the applicable menu immediately, key in the number of desired user group.

4 When selecting the [PUBLIC TEMPLATE GROUP] button, key in the “Admin Password” (6 digits), and then press the [ENTER] button. When selecting a private group, key in the selected group’s “Password” (5 digits), and then press the [ENTER] button.

- If the password has not been set at the user group registration, skip to step 5.

Select a GROUP

RECALL REGISTRATION

GROUP Number 002

PUBLIC TEMPLATE GROUP

001 Administration Group

002 Accounting Group

003 Planning Group

DELETE EDIT

2003.05.08 18:03

004 NEW GROUP

005

006

007

CANCEL ENTER 001/026 Next

5 Select the template you want to change, and then press the [EDIT] button.

6 Key in the "Password" (5 digits) for the selected template, and then press the [ENTER] button.

- If the password has not been set at the template registration, skip to step 7.

7 Press the button of "NAME 1", "NAME 2" and/or "USER NAME".

- When pressing the [NAME 1] button, the menu of entering letters ("3. ENTERING LETTERS" Page 141) is displayed, so enter the name with up to 11 letters.
- Enter the name with up to 11 letters for the "NAME 2" and with up to 30 letters for the "USER NAME" as the above manner.
- To change the password only, skip step 7.

8 When pressing the [PASSWORD] button on the menu of step 7, the menu is switched as shown on the right. Key in the changed number (5-digits identical number) in both "Password" and "Retype Password", then press the [ENTER] button.

- Press the [ENTER] button after entering the password.
- Not to change the password, skip step 8.

9 Press the [ENTER] button.

- The data of template are changed.

2003.05.

REGISTRATION

counting Group

NAME 1	MODE 1
NAME 2	
USER NAME	
PASSWORD	*****

CANCEL **ENTER**

Changing the Data of User Group

Those of public group cannot be changed.

1 Press the [TEMPLATE] button on the control panel.

2 Press the [REGISTRATION] button.

Select a GROUP

RECALL **REGISTRATION**

GROUP Number

PUBLIC TEMPLATE GROUP
001 Administration Group
002 Accounting Group
003 Planning Group

DELETE **EDIT**

3 Select the "USER GROUP" you want to change, and then press the [EDIT] button.

- Switch to the applicable menu using the [Prev] or the [Next] button.
- To display the applicable menu immediately, key in the number of the desired user group using the digital keys.

Select a GROUP

RECALL **REGISTRATION**

GROUP Number 002

PUBLIC TEMPLATE GROUP
001 Administration Group
002 Accounting Group
003 Planning Group

DELETE **EDIT**

4 Key in the “Password” (5 digits) for selected group, and then press the [ENTER] button.

- If the password has not been set at the group registration, skip to step 5.

2003.05.

NAME : Accounting Group

USER NAME :

Password : *****

CANCEL ENTER

5 Press the [NAME] button and/or the [USER NAME] button.

- When pressing the NAME button, the menu of entering letters (“3. ENTERING LETTERS” Page 141) is displayed, so enter the name with up to 20 letters.
- Enter the name with up to 30 letters for the “USER NAME” as the above manner.
- To change the password only, skip step 5.

2003.05.

RATION

GROUP

NAME NEW GROUP

USER NAME

PASSWORD

CANCEL ENTER

6 When pressing the [PASSWORD] button on the menu of step 5, the menu is switched as shown on the right. Key in the changed number (5-digit identical number) in both “Password” and “Retype Password”, then press the [ENTER] button.

- Not to change the password, skip step 5.

2003.05.

RATION

Accounting Group

Password : ***** SET

Retype Password : ***** RESET

CANCEL ENTER

7 Press the [ENTER] button.

- The data of user group are changed.

2003.05.

RATION

Accounting Group

Password : ***** SET

Retype Password : ***** RESET

CANCEL ENTER

5. DELETING TEMPLATE

Unnecessary templates can be deleted. You can also delete user groups.

Deleting a Template

- 1 Press the [TEMPLATE] button on the control panel.
- 2 Press the [REGISTRATION] button.

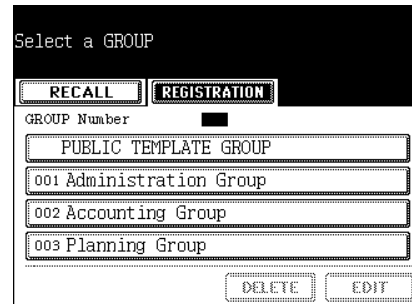

- 3 Select the group (in which the template was registered) that you want to delete, then press the [ENTER] button.

- Switch to the applicable menu using the [Prev] or the [Next] button.
- To display the applicable menu immediately, key in the number of desired user group.

- 4 When selecting the [PUBLIC TEMPLATE GROUP] button, key in the "Admin Password" (6 digits) using the digital keys, and then press the [ENTER] button. When selecting a user group, key in the selected group "Password" (5 digits) using the digital keys, and then press the [ENTER] button.

- If the password has not been set at the user group registration, skip to step 5.

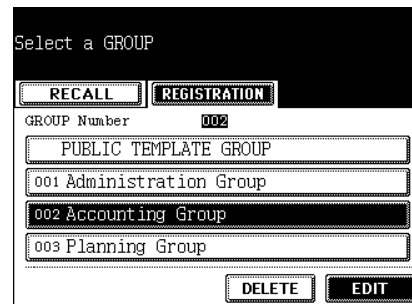

5 Select the template you want to delete, then press the [DELETE] button.

6 Key in the “Password” (5 digits) for the selected template, and then press the [ENTER] button.

- If the password has not been set at the user group registration, skip to step 7.

7 Press the [DELETE] button.

- The selected template is deleted.

Deleting a User Group

- 1 Press the [TEMPLATE] button on the control panel.
- 2 Press the [REGISTRATION] button.

Select a GROUP

RECALL REGISTRATION

GROUP Number

PUBLIC TEMPLATE GROUP

001 Administration Group

002 Accounting Group

003 Planning Group

DELETE EDIT

- 3 Select the user group you want to delete, and then press the [DELETE] button.

- Switch to the applicable menu using the [Prev] or the [Next] button.
- To display the applicable menu immediately, key in the number of desired user group.

Select a GROUP

RECALL REGISTRATION

GROUP Number 002

PUBLIC TEMPLATE GROUP

001 Administration Group

002 Accounting Group

003 Planning Group

DELETE EDIT

- 4 Key in the "Password" (5 digits) for the selected group, and then press the [ENTER] button.

- If the password has not been set at the user group registration, skip to step 5.

2003.05.

NAME : Accounting Group

USER NAME :

Password : *****

CANCEL ENTER

5 Press the [DELETE] button.

- The selected user group is deleted.

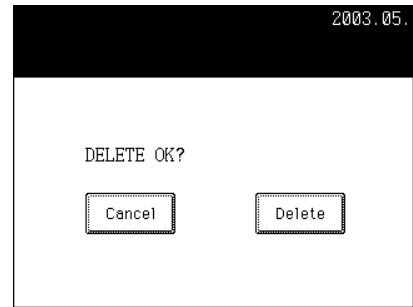

12. WHEN THE GRAPHIC SYMBOLS BLINK ON THE TOUCH PANEL

1. DESCRIPTION OF THE BLINKING GRAPHIC SYMBOLS.....	242
2. ADD PAPER SYMBOL.....	244
Adding Paper to the Drawers.....	244
Adding Paper to the Large Capacity Feeder (Optional).....	245
3. REPLACE TONER CARTRIDGE SYMBOL.....	246
4. REPLACE TONER BAG SYMBOL.....	253
5. CLEAR PAPER SYMBOL.....	254
6. ADDING STAPLES (OPTIONAL).....	268
7. REMOVING JAMMED STAPLES (OPTIONAL).....	274
8. DISPOSING OF THE PUNCHED PAPER BITS (OPTIONAL).....	281
9. CALL SERVICE SYMBOL/PERIODIC MAINTENANCE MESSAGE.....	282

1. DESCRIPTION OF THE BLINKING GRAPHIC SYMBOLS

The graphic symbol on the touch panel shows the status of the equipment. When one of the graphic symbols blinks, take the appropriate action referring to the page shown.

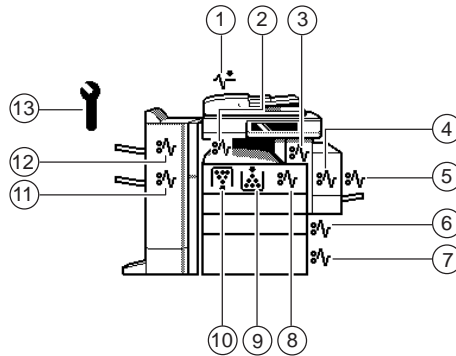

1 : CHECK ORIGINALS symbol

Blinks when an original misfeed occurs inside the reversing automatic document feeder.
"1. Paper Misfeed in the Reversing Automatic Document Feeder (optional)" Page 254

2 : RELAY UNIT MISFEED symbol

Blinks when a paper misfeed occurs in the relay unit.
"8. Paper Misfeed in the Relay Unit (optional)" Page 261

3 : FUSER MISFEED symbol

Blinks when a paper misfeed occurs in the fuser unit.
"7. Paper Misfeed in the Fuser Unit" Page 259

4 : DUPLEXER MISFEED symbol

Blinks when a paper misfeed occurs inside the automatic duplexer.
"5. Paper Misfeed in the Automatic Duplexer" Page 258

5 : BYPASS MISFEED symbol

Blinks when a sheet of paper fails to be fed into the equipment during bypass copying.
"4. Paper Misfeed on the Bypass Feed Unit" Page 258

6 : DRAWER MISFEED symbol

Blinks when paper fed from one of the drawers is misfed.
"2. Paper Misfeed in the Drawer Feeding Area" Page 256

7 : OPTIONAL FEEDER MISFEED symbol

Blinks when paper fed from the large capacity feeder (optional) is misfed.
"3. Paper Misfeed in the Large Capacity Feeder (optional)" Page 257

8 : JAM RELEASING UNIT MISFEED symbol

Blinks when a misfeed occurs in the jam releasing unit.
"6. Paper Misfeed in the Jam Releasing Unit" Page 259

9 : REPLACE TONER CARTRIDGE symbol

Blinks when the toner cartridge runs out of toner.

"3.REPLACE TONER CARTRIDGE SYMBOL"  Page 246

10: REPLACE TONER BAG symbol

Blinks when the toner bag becomes full of used toner.

"4.REPLACE TONER BAG SYMBOL"  Page 253

11: SADDLE STITCHING UNIT MISFEED symbol

Blinks when a paper misfeed occurs inside the saddle stitch unit of the finisher (optional).

"12. Paper Misfeed in the Saddle-Stitch Finisher (optional: MJ-1024)"  Page 265

12: FINISHER/HOLE PUNCH UNIT MISFEED symbol

Blinks when a paper misfeed occurs inside the finisher (optional) or hole punch unit (optional).

"9. Paper Misfeed in the Hole Punch Unit (optional)"  Page 262

13: CALL SERVICE symbol

Blinks when inspection and maintenance by a service technician are necessary.

"Call Service Symbol"  Page 282

2. ADD PAPER SYMBOL

Adding Paper to the Drawers

When the paper in the selected drawer or the large capacity feeder (optional) runs out, the drawer or large capacity feeder on the screen blinks, and "Add paper" appears. Add paper as the following procedure.

1 Pull out the drawer carefully until it comes to a stop.

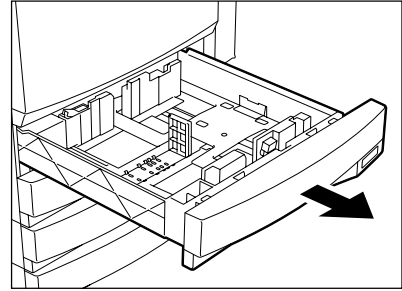

2 Place paper in the drawer(s).

- Place paper face up.
- Maximum number of sheets that can be set. "Acceptable Copy Paper Types and Sizes" Page 36
- Fan the paper well before placing it in the drawer.
- Do not add paper above the line indicated on the guide.
- Do not use creased, folded, wrinkled or damp sheets of paper.

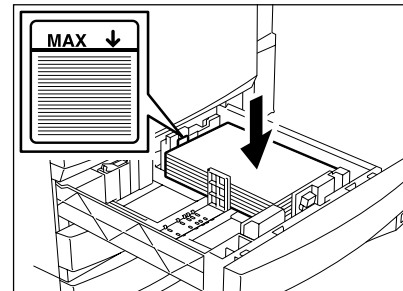

Note

Make sure that a gap of approx. 0.5 mm (less than 1 mm in total) is left between the paper and the side guide. If there is no gap, this could cause paper misfeeding.

3 Push the drawer straight into the equipment until it comes to a stop.

- Be sure to push the drawer carefully and fully in.
- This procedure can be used to add paper to any of the drawers in the paper feed pedestal (optional) as well.

Caution

Be careful not to let your fingers be caught when closing the drawer. This could injure you.

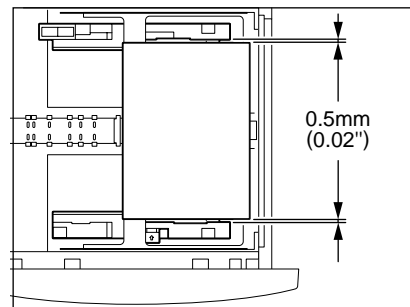

Adding Paper to the Large Capacity Feeder (Optional)

- 1 Pull out the large capacity feeder carefully until it comes to a stop.**

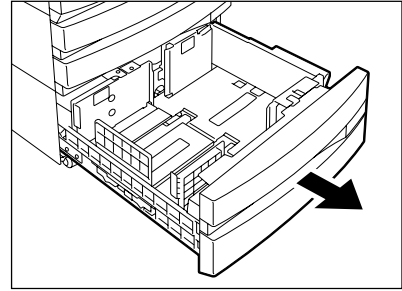

- 2 Set paper aligned in tray (A) and tray (B).**

- Place paper face up.
- Maximum number of sheets that can be set. "Acceptable Copy Paper Types and Sizes"  Page 36
- Fan the paper well, then set it for (A) to the right side, and set it for (B) to the left side. (The paper can be set neatly if you pile up the paper little by little alternately in the tray (A) and (B).) Be sure that the centre lever is not open. (Refer to the labels attached in the large capacity feeder.)
- Do not add paper above the line indicated on the guide.
- Paper starts being fed from the elevator tray (A) at first, and when it runs out, the paper on the tray (B) moves to the position (A).
- Do not use creased, folded, wrinkled or damp sheets of paper.

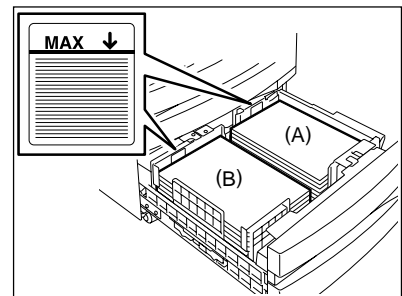

- 3 Push the drawer of the large capacity feeder straight into the equipment until it comes to a stop.**

- Close it completely. The elevator tray automatically moves up to the paper feeding position.

Caution

Be careful not to let your fingers be caught when closing the drawer. This could injure you.

3. REPLACE TONER CARTRIDGE SYMBOL

When the toner in the cartridge runs out, the REPLACE TONER CARTRIDGE symbol blinks.

When the black toner runs out, "Install new Black toner cartridge" appears.

When the yellow, magenta or cyan toner runs out, "Install new ***** toner cartridge. Press *** button." appears. Then press the [***] button.

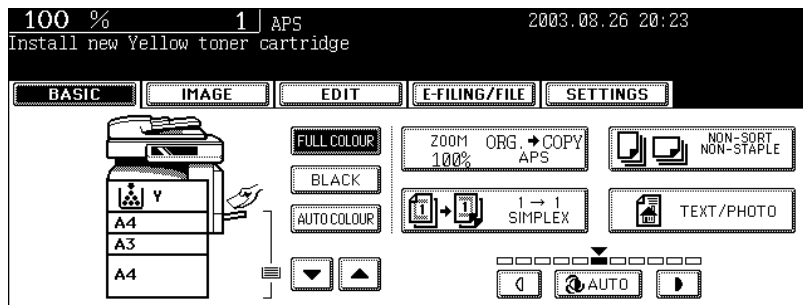

Recommendation for Original Toner

At Toshiba we strive to provide you with the highest quality images. Please use genuine Toshiba toner to ensure that you continue to receiving quality output that is environmentally safe.

TOSHIBA

T-3511E-K

FOR e-STUDIO3511/4511
NET 675 gr

ORIGINAL & GENUINE TOSHIBA TONER

- HANDLE WITH CARE
- STORE IN A DRY PLACE BELOW 35°C(95°F)
- READ THE OPERATING INSTRUCTIONS OF THE MACHINE BEFORE USING
- SHAKE WELL BEFORE USING
- MANIPULER AVEC PRECAUTION
- GARDER DANS UN ENDROIT SANS HUMIDITE OU LA TEMPERATURE AMBIANTE EST MOINS DE 35°C
- LUSER LE MANUEL D'EMPLOI DE L'APPAREIL AVANT D'EN FAIRE USAGE
- AGITER AVANT EMPLOI

COMPONENTS:
Polyester resin, Organic pigment, Wax, Polypropylene, Silica

TOSHIBA TEC CORPORATION
1-1-1, Honda, Yokohama, City, Japan
Tokyo 101-8542, Japan
PHONE: 81-3-54389554

MADE IN CHINA / FABRIQUE EN CHINE
HERGESTELLT IN CHINA
HECHO EN CHINA / FATTO IN CHINA PAT. P.

TOSHIBA

T-3511E-Y

FOR e-STUDIO3511/4511
NET 250 gr

ORIGINAL & GENUINE TOSHIBA TONER

- HANDLE WITH CARE
- STORE IN A DRY PLACE BELOW 35°C(95°F)
- READ THE OPERATING INSTRUCTIONS OF THE MACHINE BEFORE USING
- SHAKE WELL BEFORE USING
- MANIPULER AVEC PRECAUTION
- GARDER DANS UN ENDROIT SANS HUMIDITE OU LA TEMPERATURE AMBIANTE EST MOINS DE 35°C
- LUSER LE MANUEL D'EMPLOI DE L'APPAREIL AVANT D'EN FAIRE USAGE
- AGITER AVANT EMPLOI

COMPONENTS:
Polyester resin, Organic pigment, Wax, Polypropylene, Silica

TOSHIBA TEC CORPORATION
1-1-1, Honda, Yokohama, City, Japan
Tokyo 101-8542, Japan
PHONE: 81-3-54389554

MADE IN CHINA / FABRIQUE EN CHINE
HERGESTELLT IN CHINA
HECHO EN CHINA / FATTO IN CHINA PAT. P.

TOSHIBA

ORIGINAL & GENUINE TOSHIBA TONER

T-3511E-K

NET 675 gr

FOR e-STUDIO3511/4511

COMPONENTS: Polyester resin,
Carbon black(1333-86-4), Wax,
Polypropylene, Silica

- SHAKE WELL BEFORE USING.
- AGITER AVANT EMPLOI.
- VOR GEBRAUCH GUT SCHÜTTELN.
- AGITARE BENE PRIMA DELL'USO.
- SACUDIR BIEN ANTES DE USER.
- TAP THE BOTTLE REPEATEDLY.
- TAPER DE FAÇON REPÉTÉE SUR LA BOUTEILLE.
- EINIGE MALE WIEDERHOLT AUF DIE TONERFLASCHE KLOPFEN.
- DARE ROPETUTAMENTE DEI COLPETTIALLA BOTTIGLIA.
- GOLPEE SUAVEMENTE LA BASE DEL CARTUCHO DE TONER.

TOSHIBA AMERICA BUSINESS SOLUTIONS, INC.
2 Musik, California 92618-1631
(949)462-6000

MADE IN U.S.A. / FABRIQUE AUX ETAS-UNIS
HERGESTELLT IN U.S.A.
HECHO EN U.S.A. / FATTO IN U.S.A.

BLACK
NOIR
SCHWARZ
NEGRO
NERO

Replacing the Black (K) Toner Cartridge

1 Open the front cover.

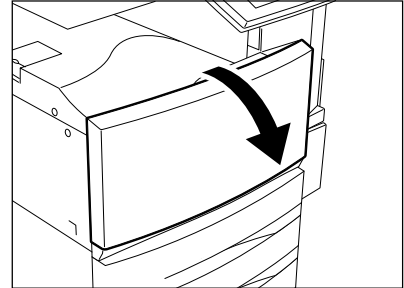

2 While pushing on the latch, lower the cartridge holder toward you.

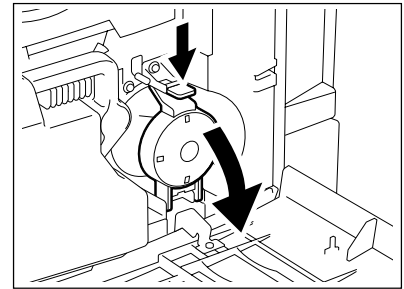

3 Pull the cartridge out carefully.

- If you cannot pull it straight out, pull it out rotating it clockwise.

Tip

If it cannot be pulled out, close the front cover, turn the power switch OFF and then ON again. When "Install new Black toner cartridge" appears, start the procedure again from step 1.

Caution

NEVER attempt to incinerate toner cartridges. This could cause an explosion.

DO NOT dispose of used toner cartridges. Your service technician will collect them.

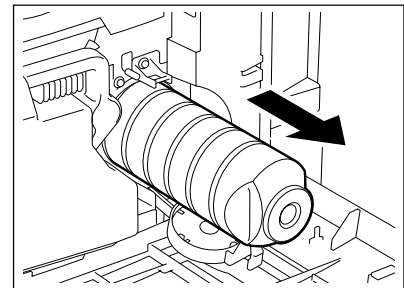

4 Tap and shake the new toner cartridge well to loosen the toner inside.

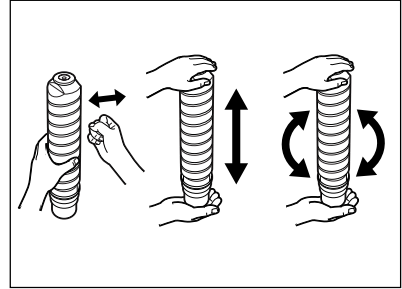

5 Stand the toner cartridge upright, and pull out the seal in the direction of the arrow.

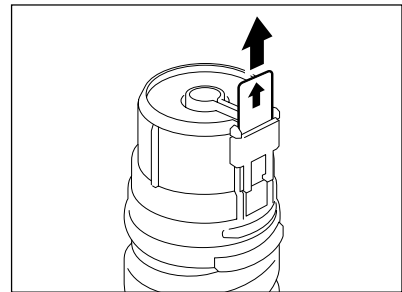

6 Insert the cartridge completely.

- Match the label (orange) on the equipment with the shutter (orange) on the toner cartridge, then insert it.
- If the cartridge becomes dirty with toner, clean it before inserting it.

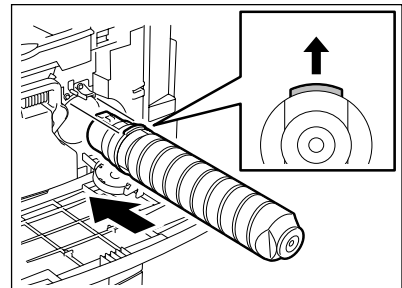

7 Return the cartridge holder to its original position.

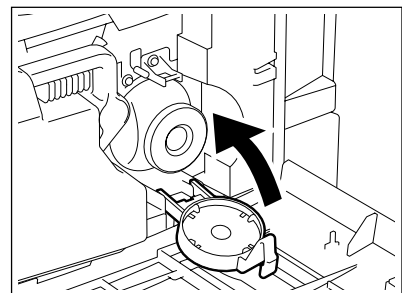

8 Close the front cover.

- "Wait adding toner" appears. The equipment automatically starts supplying toner.

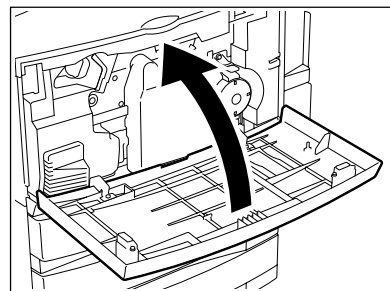

Replacing the Yellow (Y), Magenta (M), Cyan (C) Toner Cartridge

- * When you want to replace a cartridge before the REPLACE TONER CARTRIDGE symbol blinks, see the [User Function Guide].
- * When replacing a toner cartridge, the procedures are displayed on the screen. Follow them by pressing

▼ and ▲ buttons to switch the screen.

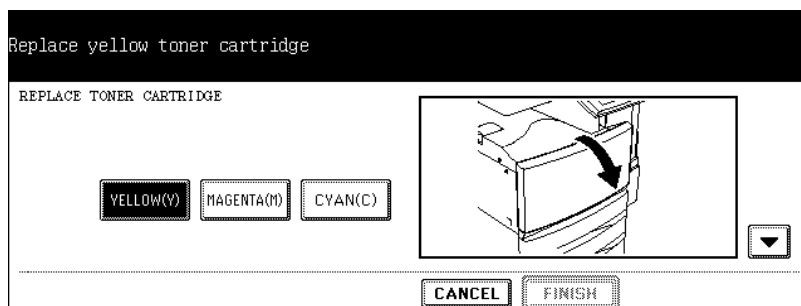

1 When the colour toner cartridge becomes empty, the screen for replacing it is displayed. Press the button corresponding to the colour to be replaced.

- The empty toner cartridge of Yellow (Y), Magenta (M) or Cyan (C) automatically moves to the appropriate position to be replaced.

Tips

- When pressing the [CANCEL] button without replacing the toner cartridge, the screen returns to the Basic screen. However, if the toner cartridge is not replaced, the screen for replacing it is displayed every time after the specified automatic function clear time passes.
- When the colour cartridge is empty, outputting in the black-and-white mode is available.

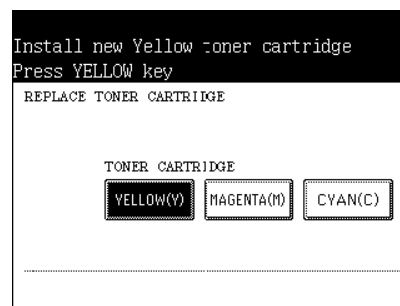

- 2** The cartridge is moved to the appropriate position to be replaced.

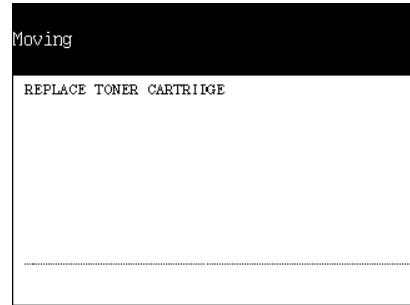

- 3** Open the front cover.

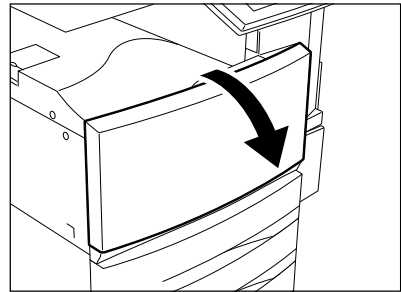

- 4** Push on the latch, and then pull out the cartridge.

Caution

NEVER attempt to incinerate toner cartridges. This could cause an explosion.
DO NOT dispose of used toner cartridges. Your service technician will collect them.

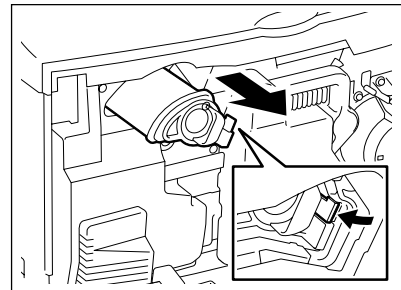

- 5** Shake the new toner cartridge well to loosen the toner inside.

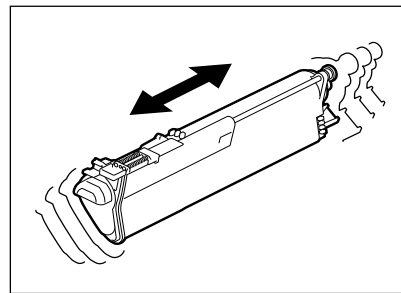

6 Holding the new toner cartridge, pull out the seal in the direction of the arrow.

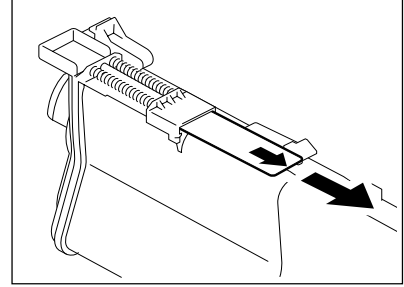

7 Insert the cartridge completely.

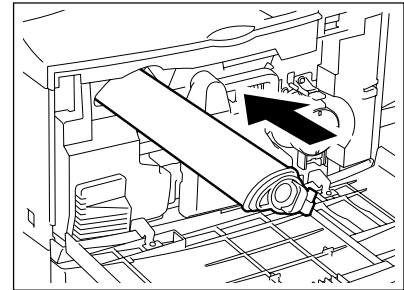

8 Press the [FINISH] button.

- When 2 or more cartridges are empty, repeat the above procedure from step 1 to 6.



9 Close the front cover.

- "Wait adding toner" appears. The equipment automatically starts supplying toner.

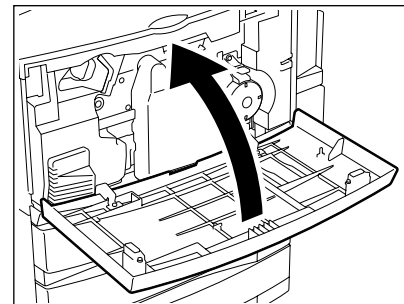

4. REPLACE TONER BAG SYMBOL

When the toner bag becomes full of used toner, the REPLACE TONER BAG symbol blinks and “Dispose of used toner” appears.

1 Open the front cover.

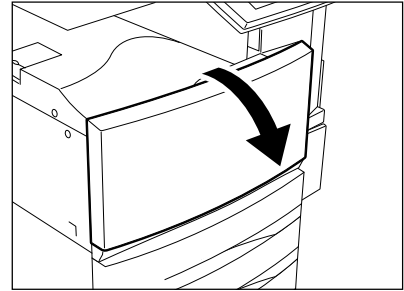

2 Pull the toner bag out carefully.

Caution

NEVER attempt to incinerate toner bags. This could cause an explosion.

DO NOT dispose of used toner bags. Your service technician will collect them.

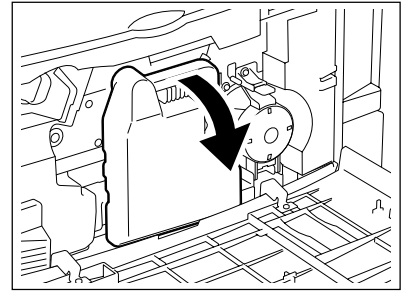

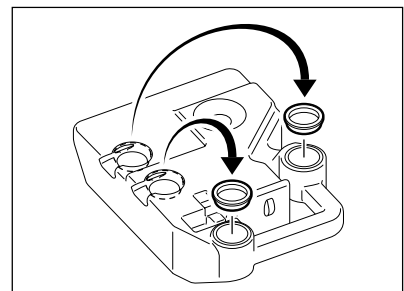

3 Put the lid on the toner bag.

4 Set a new toner bag, and then close the front cover.



5. CLEAR PAPER SYMBOL

When a paper misfeed occurs in the equipment, the  or  symbol on the touch panel blinks in the positions where the paper is misfed. In that case, remove the misfed paper using the following procedure referring to the illustration below.

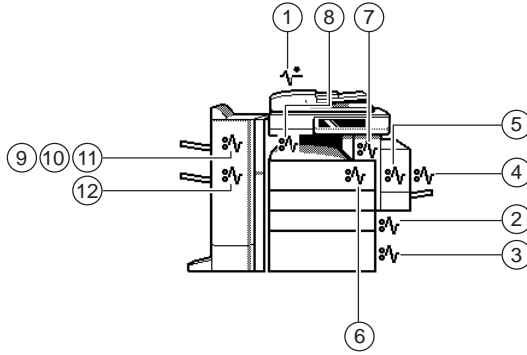

1. Paper Misfeed in the Reversing Automatic Document Feeder (optional)

- 1 Push the button on the reversing automatic document feeder to open the upper cover.**

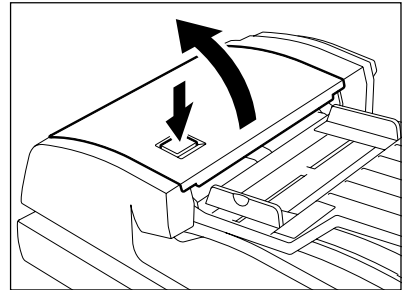

- Remove any misfed originals.

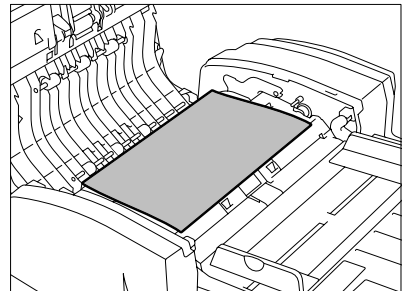

2 Rotate the green knob to remove any misfed originals.

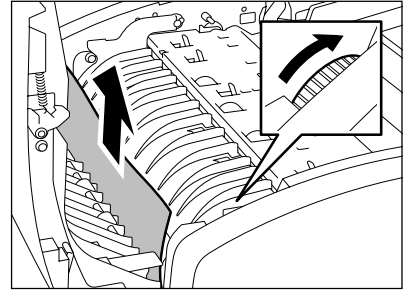

3 If the misfed original still remains, rotate the green knob to the opposite direction against the step 2. Then remove it.

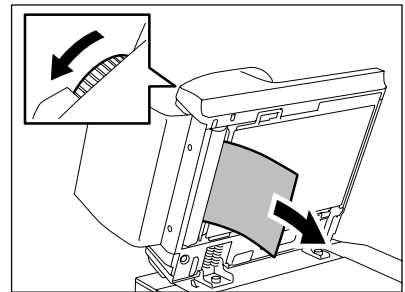

4 Lift the green handle.

- Remove any misfed originals.

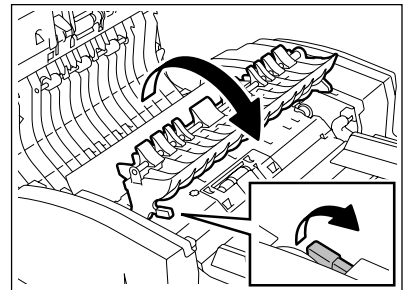

5 Rotate the green knob on your side in the direction of the arrow and remove any misfed originals.

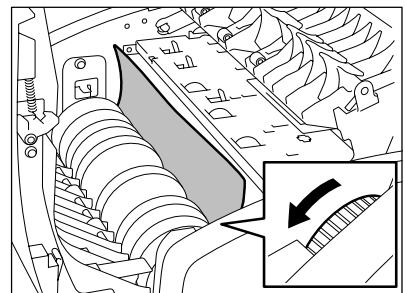

- 6** Lift the original feeding tray and remove any misfed originals.

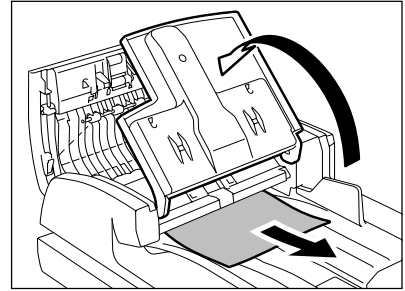

- 7** Lower the original feeding tray, move the green knob toward the front and open the cover.

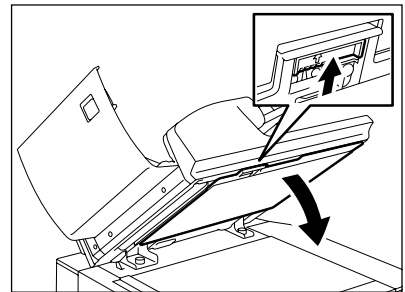

- 8** Remove any misfed paper.
- 9** Close the upper and lower cover.

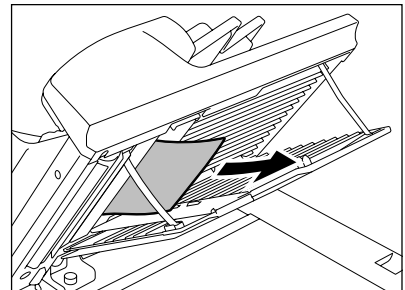

12

2. Paper Misfed in the Drawer Feeding Area

- 1** Open the cover.

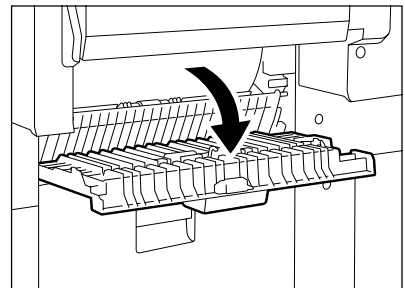

- 2 Remove any misfed paper.
- 3 Close the cover.

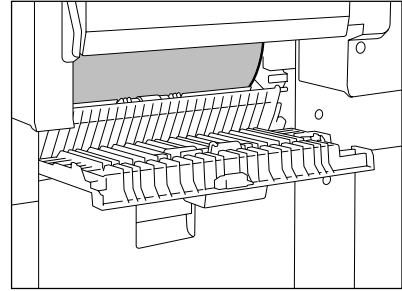

3. Paper Misfeed in the Large Capacity Feeder (optional)

- 1 Open the cover.

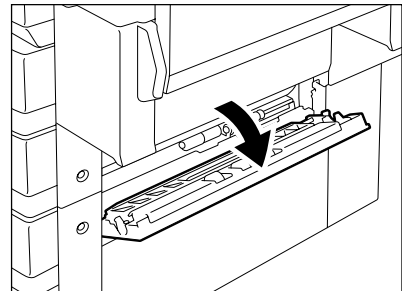

- 2 Remove any misfed paper.

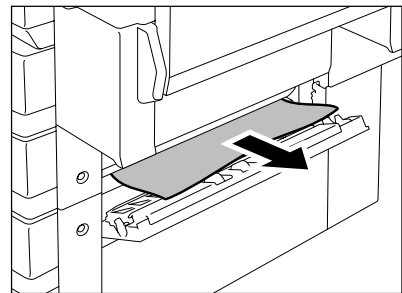

Tip

Paper Misfeed in the Paper Feed Pedestal (optional)
-Open the cover as shown on the right, and remove any misfed paper.

- 3 Close the cover.

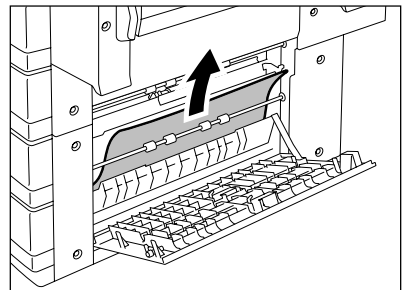

4. Paper Misfeed on the Bypass Feed Unit

- 1 Pull out misfed paper on the bypass tray.

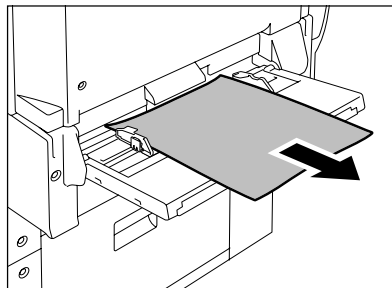

5. Paper Misfeed in the Automatic Duplexer

- 1 Make sure that the bypass tray is opened, and then open the automatic duplexer.

Caution

- Be careful not to let your fingers be caught between the equipment and the automatic duplexer. This could injure you.
- Do not touch the metal portion of a guide board as it could burn you.

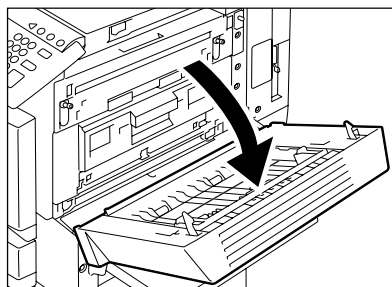

- 2 Lift the paper guide as indicated by the arrow and remove any misfed paper.

- 3 Lower the paper guide and return the automatic duplexer to the original position.

- Be sure to close both sides of the Automatic Duplexer firmly.

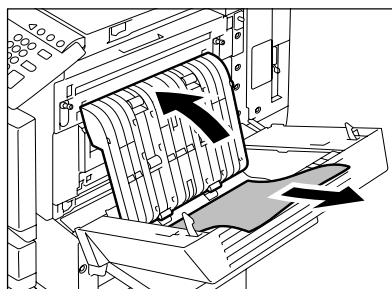

6. Paper Misfeed in the Jam Releasing Unit

- 1 Make sure that the bypass tray and the automatic duplexer are open, then open the jam releasing unit cover.

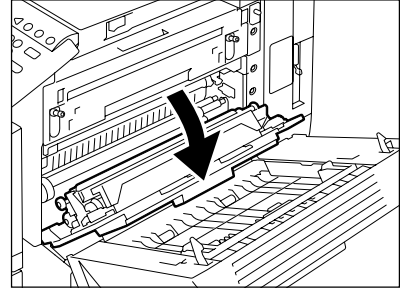

- 2 Rotate the green knob as indicated by the arrow toward the inside and remove any misfed paper.

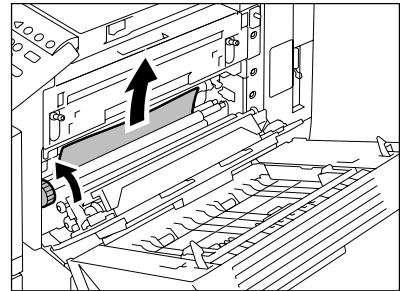

- 3 Return the jam releasing unit cover, the automatic duplexer and the bypass tray to the original positions.

- Be sure to close both sides of the automatic duplexer firmly.

7. Paper Misfeed in the Fuser Unit

- 1 Make sure that the bypass tray, the automatic duplexer and the jam releasing unit are open, and push down the 2 fuser pressure release levers until they come to a stop.

Tip

Be sure to perform step 1 without fail.

Caution

DO NOT touch the fuser unit and the metal area around it. Since they are very hot, you could be burned or the shock could cause an injury to your hand in the equipment.

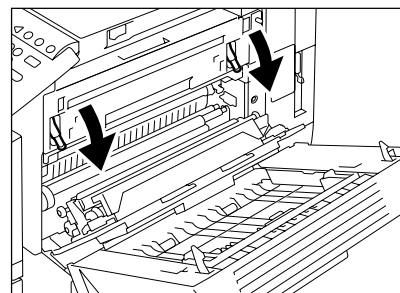

2 Open the fuser unit cover.

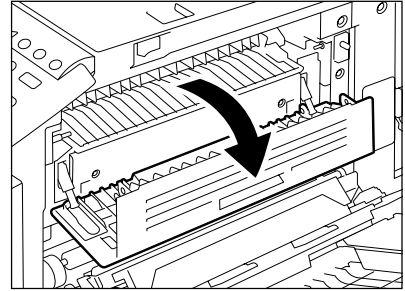

3 Holding the knob (A), open the transport guide.

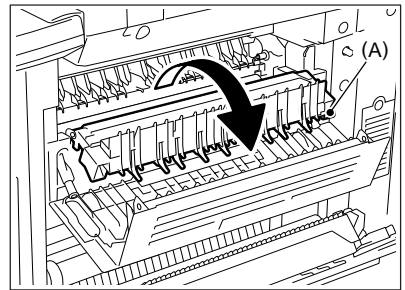

4 Remove any misfed paper inside the fuser unit.

5 Close the transport guide and the fuser unit cover. Push up the fuser pressure release lever to return the jam releasing unit cover, the automatic duplexer and the bypass tray to the original positions.

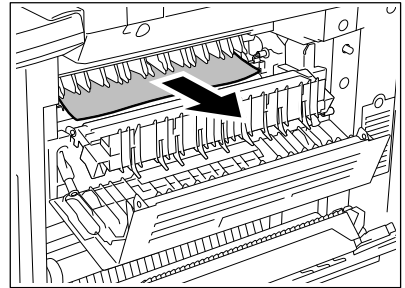

6 Pull the lever toward you to loose the misfed paper. Hook a finger under the loosen part of it, and then pull it out.

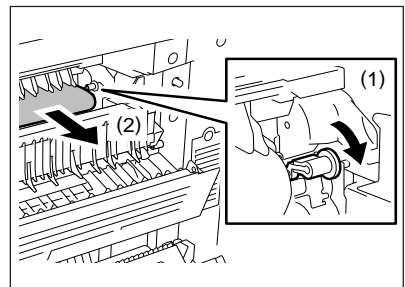

-
- 7** Furthermore, pull it out with both hands to remove it.

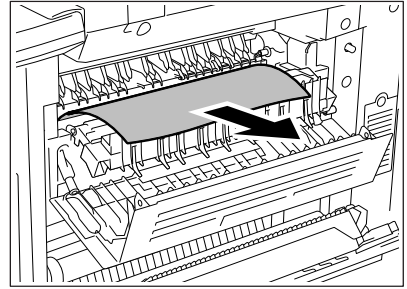

8. Paper Misfeed in the Relay Unit (optional)

- 1** Holding the cover handle of the relay unit, open the cover.

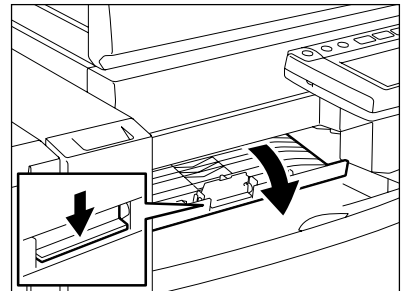

- 2** Remove any misfed paper that is inside the relay unit.

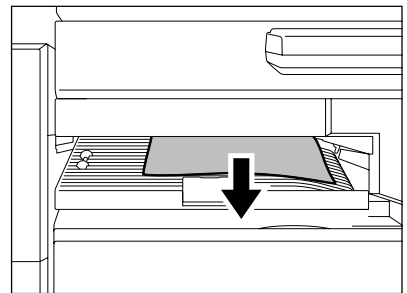

- Remove the misfed paper from the fuser unit side if it is easier.

- 3** Close the relay unit cover.

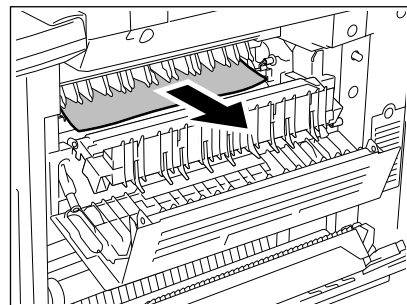

9. Paper Misfeed in the Hole Punch Unit (optional)

- 1 Open the front cover of the hole punch unit (optional).

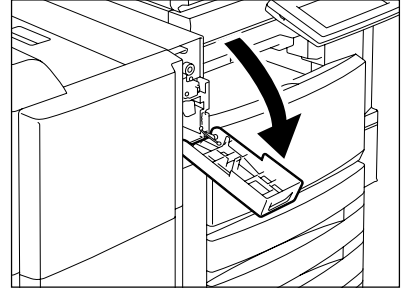

- 2 Raise the Hole Punch Unit.

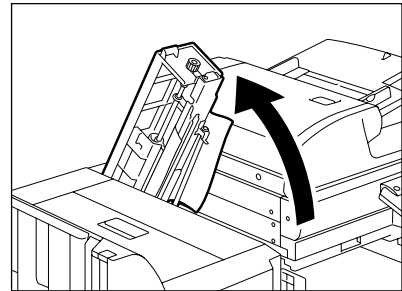

- 3 Rotate the green knob to locate the arrow within the area on the label.

- Under this condition, the punchers are up, allowing the paper shown in the illustration to be removed.
- If the misfed paper still remains, open the upper cover of the finisher to remove it.

- 4 Return the hole punch unit to the original position and close the front cover.

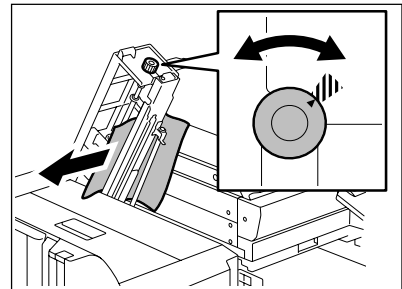

10. Paper Misfeed in the Finisher (optional: MJ-1024/1023)

- 1 Open the upper cover of the finisher until it locks.

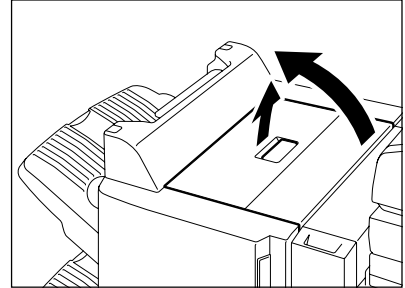

- Remove any misfed paper.

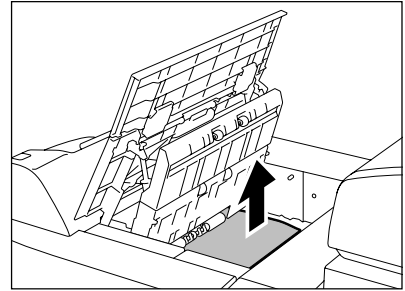

- 2 Hold up the guide and remove any misfed paper in the paper exit area.
- 3 Close the upper cover.

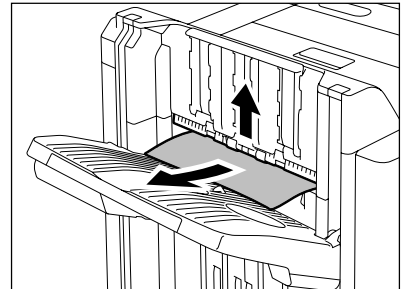

11. Paper Misfeed in the Single-staple Finisher (optional: MJ-1022)

- 1 Pull the lever and move the finisher carefully away from the copier.**

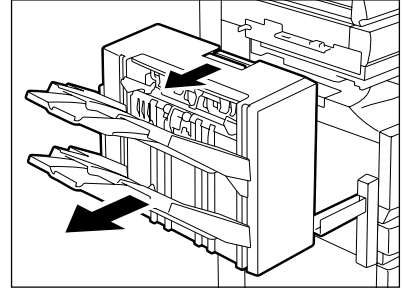

- 2 Lift the green lever and remove any misfed paper.**

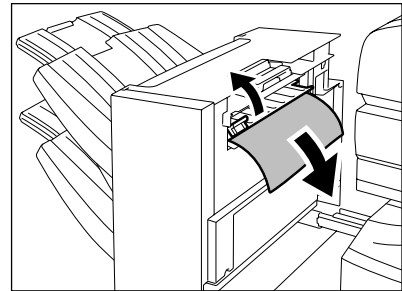

- 3 Remove any misfed paper in the paper exit area.**

- 4 Install the finisher to the equipment.**

Caution

Be careful not to let your fingers be caught between the equipment and the finisher (optional).
This could injure you.

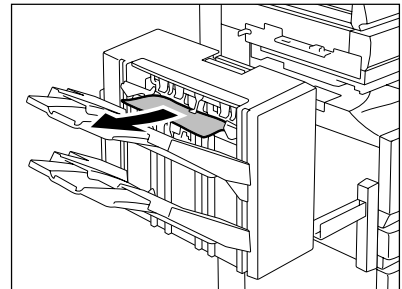

12. Paper Misfeed in the Saddle-Stitch Finisher (optional: MJ-1024)

* Only when the saddle-stitch finisher (MJ-1024, optional) is installed

- 1** Open the front cover of the saddle-stitch finisher.

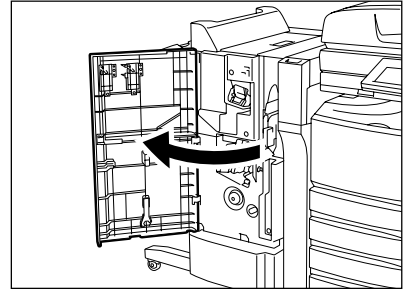

- 2** Slide the green handle toward the right and remove the misfed paper.

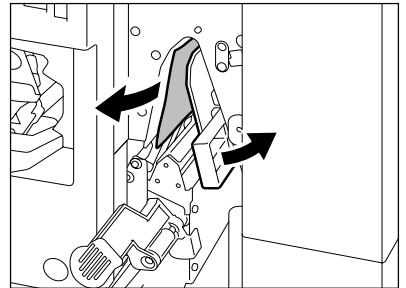

- 3** Press the lower portion of the green handle.

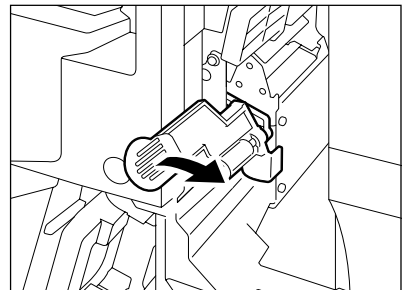

- 4** Remove any misfed paper and return the handle to its original position.

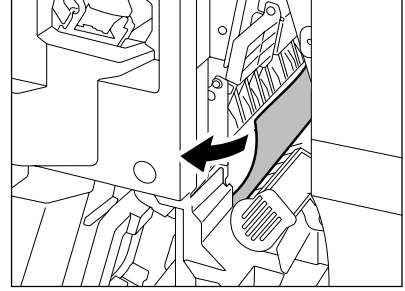

- 5** Turn the right-hand knob anticlockwise.

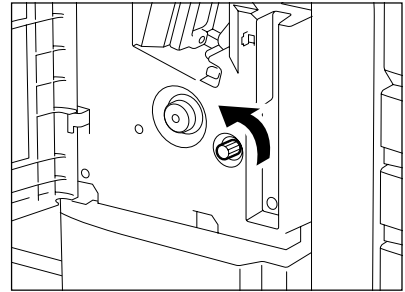

- 6** Pushing the left-hand knob, turn it clockwise.

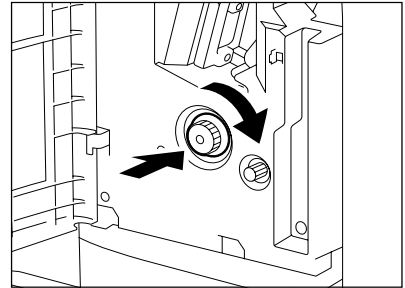

- 7** Remove any misfed paper on the exit side of the saddle stitch unit.

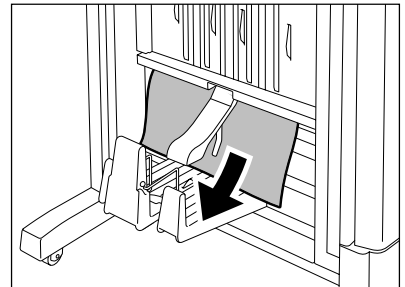

-
- 8** Raise the lever and open the exit cover of the saddle stitch unit.

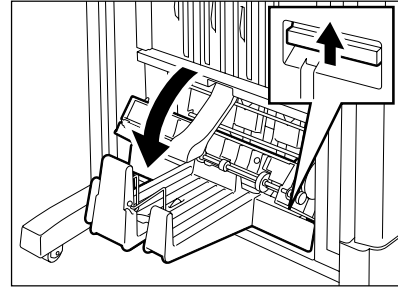

- Remove any misfed paper.

- 9** Close the exit cover and the front cover.

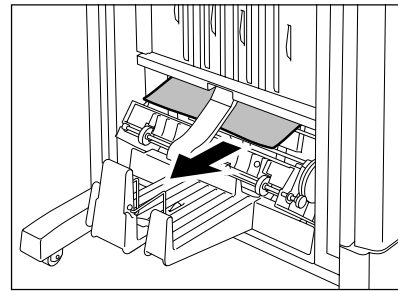

6. ADDING STAPLES (OPTIONAL)

When the staple in the cartridge runs out, "Check staple cartridge" appears.
Add staples to the cartridge according to the procedure below.

Saddle-Stitch Finisher (MJ-1024)/Multi-Staple Finisher (MJ-1023)

1 Open the front cover of the finisher.

- When MJ-1024 is installed

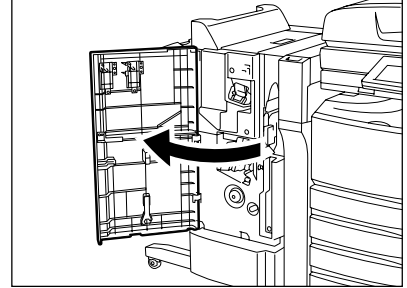

- When MJ-1023 is installed

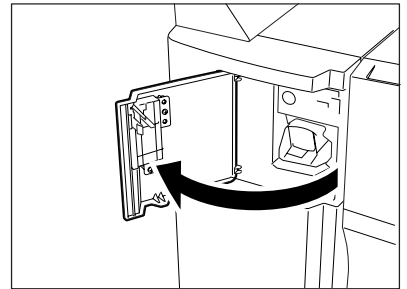

2 Take out the staple cartridge.

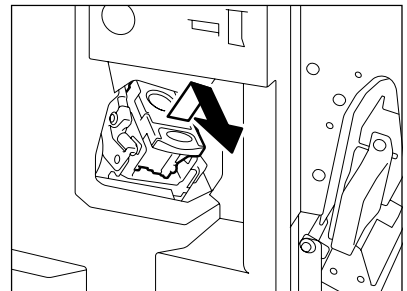

3 Take out the empty staple case from the staple cartridge.

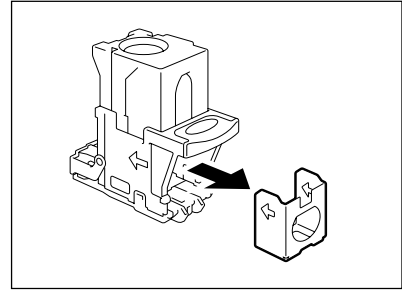

4 Pull out the seal holding the staples.

- Be careful that the staples are not misaligned.

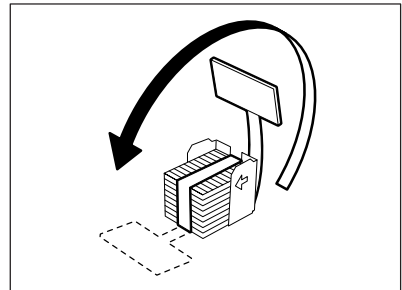

5 Push the new staple case into the staple cartridge until it clicks.

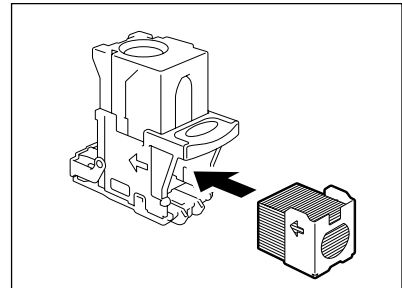

6 Return the staple cartridge to its original position.

- Insert the cartridge until it is caught by the latch and fixed with a click sound.

7 Close the front cover of the finisher.

Note

If "Check staple cartridge" remains, repeat the above procedure from step 1 to 7.

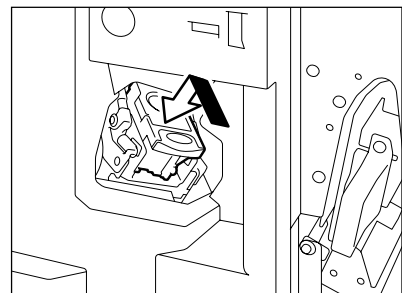

Saddle-Stitch Finisher (MJ-1024)

* Only when the saddle-stitch finisher (MJ-1024, optional) is installed

1 Open the front cover of the finisher.

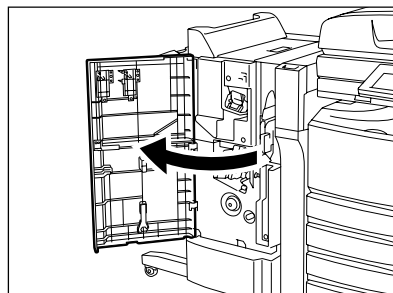

2 Slide the saddle stitch unit carefully toward the front.

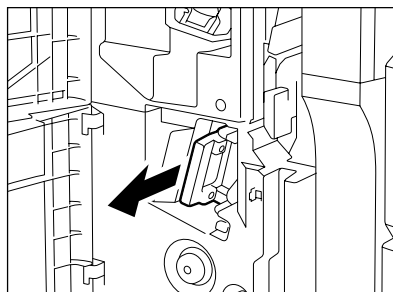

3 Pull the handle of the saddle stitch holder (1) toward you and turn it (2) 90° in the direction of the arrow.

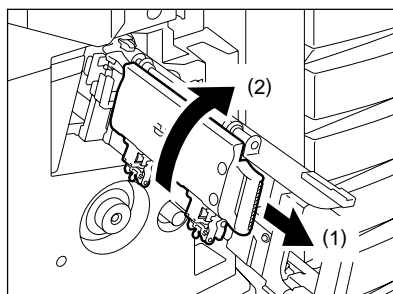

4 Remove the empty staple case and replace it with a new one.

- Replace both staple cases with new ones.

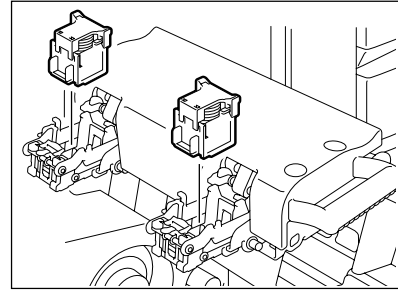

5 Return the saddle staple to its original position.

- Pull the handle of the saddle stitch holder (1) toward you and turn it (2) 90° in the direction of the arrow.

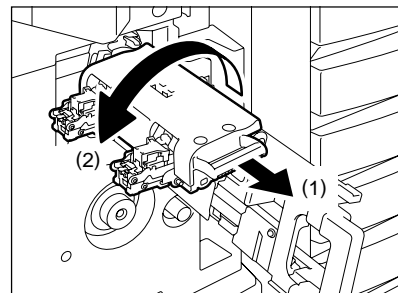

6 Return the saddle stitch unit to its original position.

7 Make sure that A3, A4-R or B4 paper is set.

- If any of the above paper sizes is not set, test stapling cannot be performed.

8 Close the front cover of the finisher. Then, test stapling is automatically performed on a blank sheet.

- This is performed to avoid empty stitching.

Tip

If there is a test stapling failure and "Check staple cartridge" remains, repeat the above procedure from step 1 to 8.

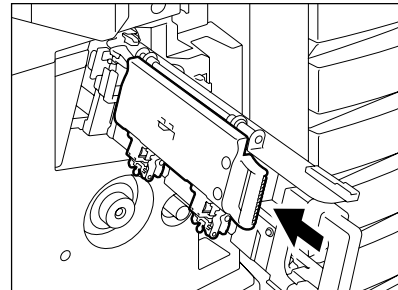

Single-Staple Finisher (MJ-1022)

- 1 Pull the lever and move the finisher away carefully from the equipment.**

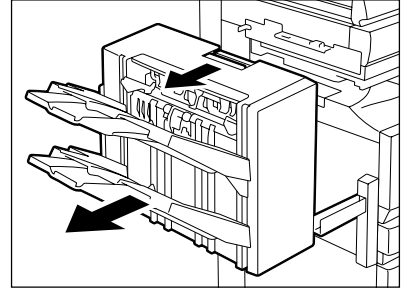

- 2 Take out the staple cartridge.**

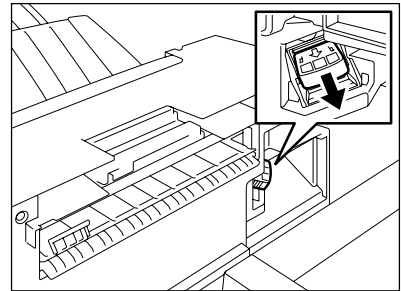

- 3 Remove the empty staple case from the staple cartridge.**

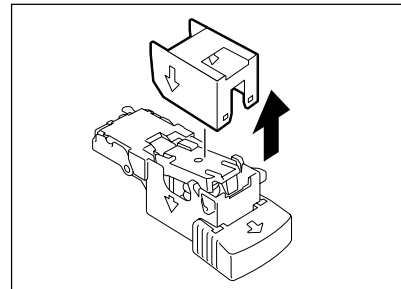

- 4 Set the new staple case.**

- Push a new staple case into the staple cartridge until it clicks.
- Do not remove the seal holding the staples before the staple case is set in the cartridge.

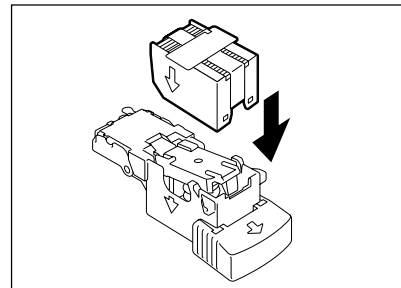

5 Pull out the seal holding the staples straight upward.

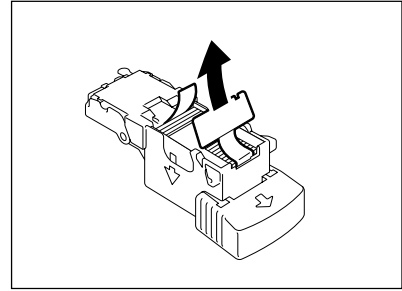

6 Return the staple cartridge to its original position.

- Insert the cartridge until it is caught by the latch and fixed with a click sound.

Tip

If "Check staple cartridge" remains, repeat the above procedure from step 1 to 6.

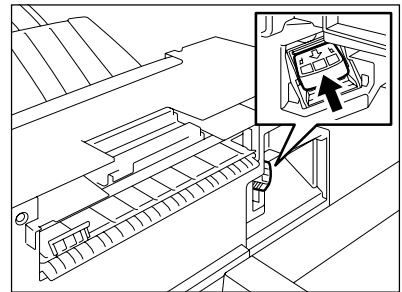

7 Install the finisher to the equipment.

Caution

Be careful not to let your fingers be caught between the equipment and the finisher (optional).

This could injure you.

7. REMOVING JAMMED STAPLES (OPTIONAL)

If copies have not been stapled in the staple mode, “Examine stapler” appears. This shows that the staples are jammed. Remove them as described below.

Saddle-Stitch Finisher (MJ-1024)/Multi-Staple Finisher (MJ-1023)

1 Open the front cover of the finisher.

- When MJ-1024 is installed

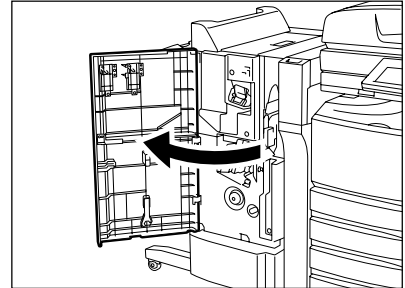

- When MJ-1023 is installed

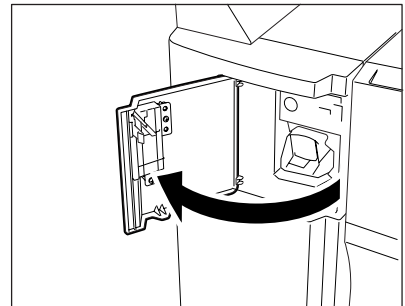

2 Take out the staple cartridge.

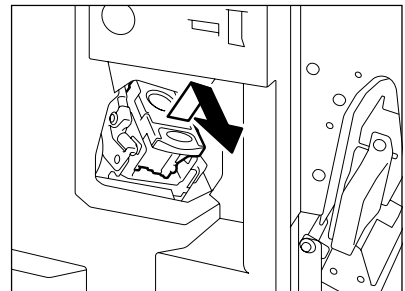

3 Lower the staple cover while holding the knob.

- A: stapler

Caution

Do not touch the stapling area. The stapler could injure you.

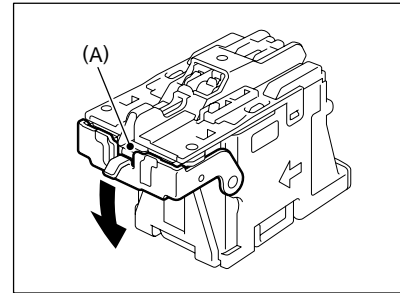

4 Remove any jammed staples.

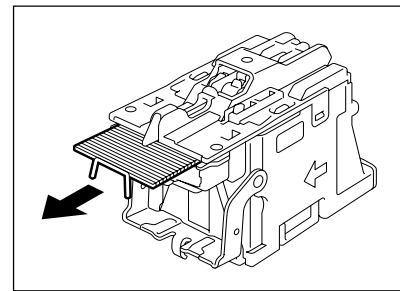

5 Return the staple cover to its original position while holding the knob.

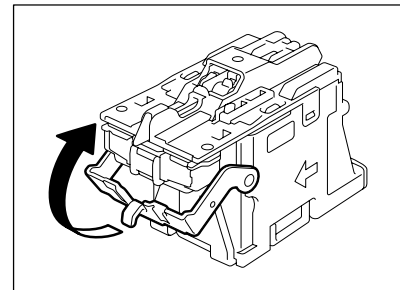

6 Return the staple cartridge to its original position.

- Insert the cartridge until it is caught by the latch and fixed with a click sound.

7 Close the front cover of the finisher.

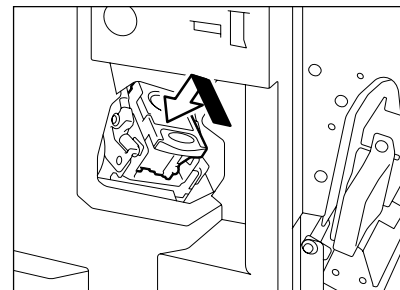

Saddle-Stitch Finisher (MJ-1024)

* Only when the saddle-stitch finisher (MJ-1024, optional) is installed

1 Open the front cover of the finisher.

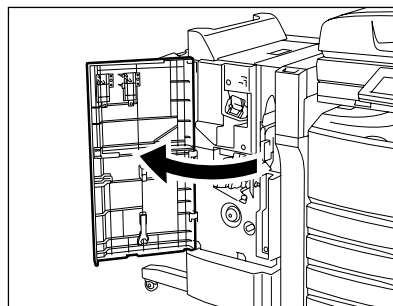

2 Slide the saddle stitch unit carefully toward the front.

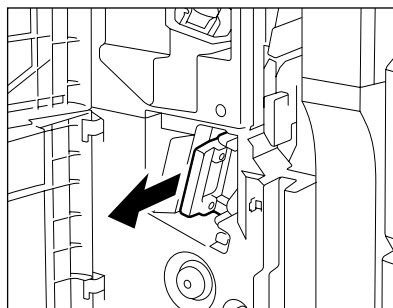

3 Pull the handle of the saddle stitch holder (1) toward you and turn it (2) 90° in the direction of arrow.

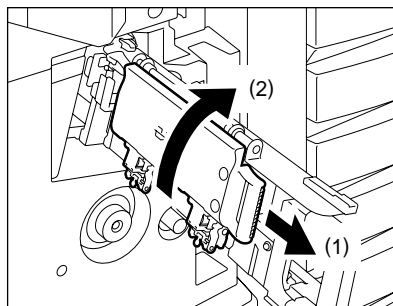

- 4** Remove the staple cases from the staple cartridges.

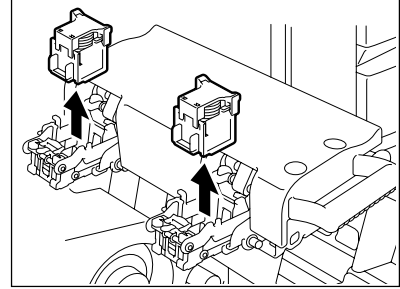

- 5** While pushing down on the lever (1), pull up the knob (2).

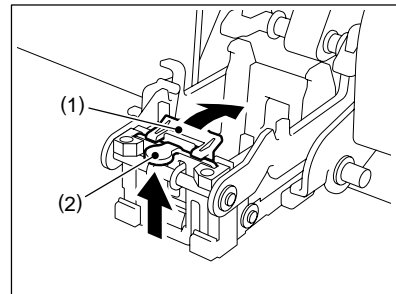

- 6** Remove any jammed staples, and then return the knob (2) to its original position.

Caution

Do not touch the stapling area. The stapler could injure you.

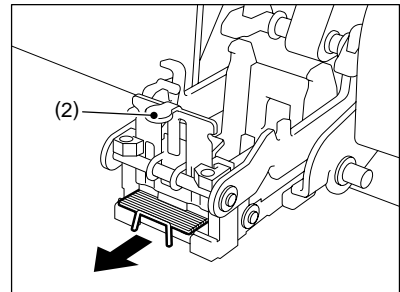

- 7** Return the staple cases to their original position.

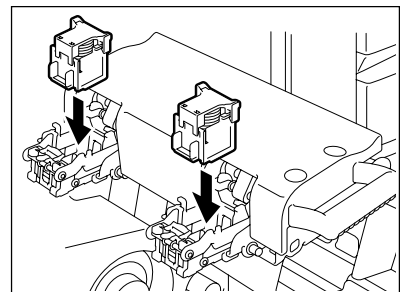

8 Return the saddle staple to its original position.

- Pull the handle of the saddle stitch holder (1) toward you and turn it (2) 90° in the direction of the arrow.

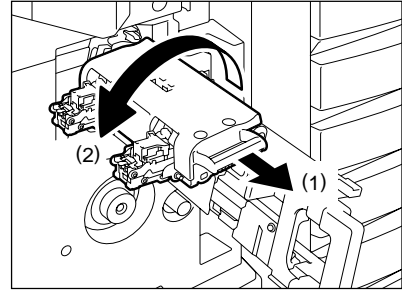

9 Return the saddle stitch unit to its original position.

10 Make sure that A3, A4-R or B4 paper is set.

- If any of the above paper sizes is not set, test stapling cannot be performed.

11 Close the front cover of the finisher. Then test stapling is automatically performed on a blank sheet.

- This is performed to avoid empty stitching.

Tip

If there is a test stapling failure and "Check staple cartridge" remains, repeat the above procedure from step 1 to 11.

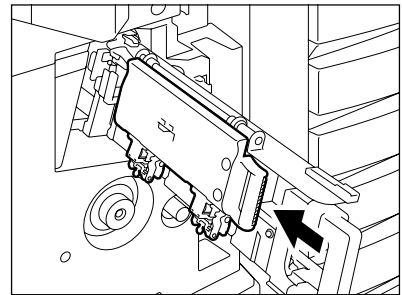

Single-Staple Finisher (MJ-1022)

- 1 Pull the lever and move the finisher away carefully from the equipment.**

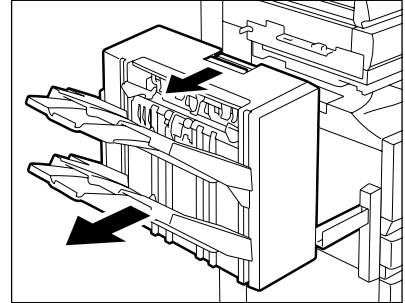

- 2 Take out the staple cartridge.**

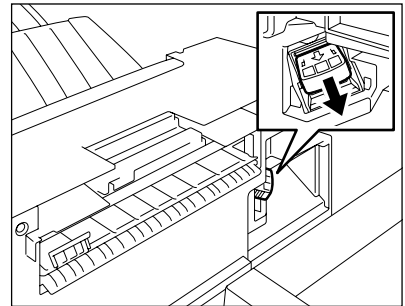

- 3 Lower the staple cover while holding the knob.**

- A: stapler

Caution

Do not touch the stapling area. The stapler could injure you.

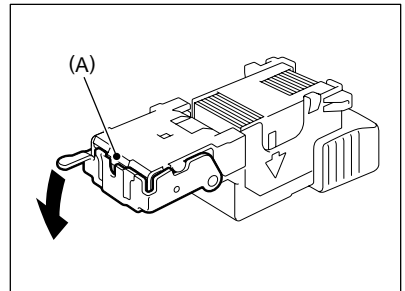

- 4 Remove any jammed staples.**

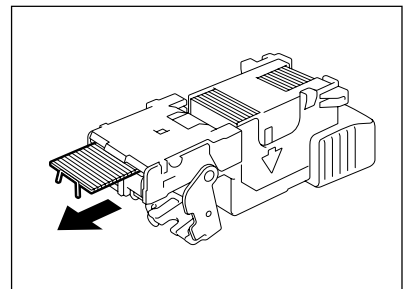

5 Return the staple cover to its original position while holding the knob.

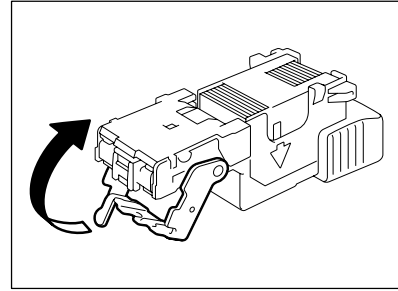

6 Return the staple cartridge to its original position.

- Insert the cartridge until it is caught by the latch and fixed with a click sound.

7 Install the finisher to the equipment.

Caution

Be careful not to let your fingers be caught between the equipment and the finisher (optional).

This could injure you.

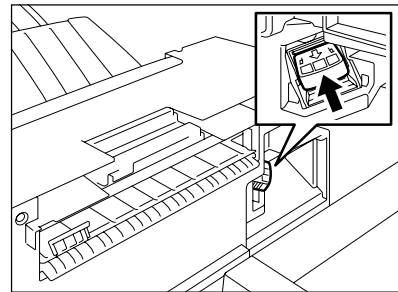

8. DISPOSING OF THE PUNCHED PAPER BITS (OPTIONAL)

When paper bits punched from copies have accumulated to a certain level, "READY (HOLE PUNCH DUST BIN IS FULL)" appears. Dispose of the paper bits as described below.

- 1** Open the front cover of the hole punch unit.

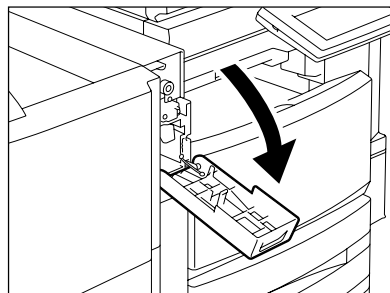

- 2** Pull out the black case, and then dispose of the paper bits.
- 3** Return the case to its original position.
- 4** Close the front cover of the hole punch unit.

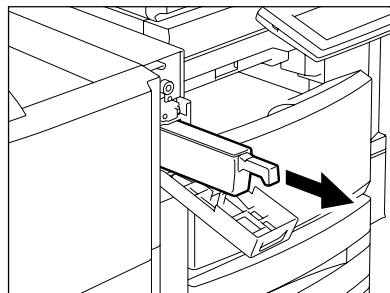

9. CALL SERVICE SYMBOL/PERIODIC MAINTENANCE MESSAGE

Call Service Symbol

Warning

Never attempt to repair, disassemble or modify the equipment by yourself. You could cause a fire or get an electric shock.

Always contact your service representative for maintenance or repair of the internal parts of the copier.

When the CALL SERVICE (Y) symbol blinks and “Misfeed in copier Press HELP” appears, output is no longer possible. Contact your service technician.

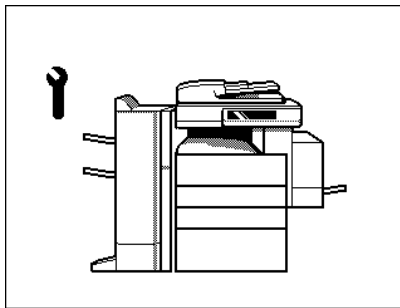

Note

When the CALL SERVICE (Y) or CLEAR PAPER (8v) symbol is blinking, if you press the [CLEAR] button and the digital key [8] together before you turn off the power, the corresponding error code will appear at the output quantity display area only while both are held down. Please provide the error code when you ask for service.

Tip

Since heaters are used to fix toner images to the paper, a heat-sensing safety circuit is incorporated in this equipment. After you turn ON the power switch, if a certain temperature is not attained within a specified period of time, the safety circuit assumes that something abnormal has happened and it stops the equipment's operation.

This can happen when the temperature is low even if the equipment is not malfunctioning. If this occurs, turn the power switch OFF and then ON again. Repeat this procedure twice, and if the problem still persists, turn OFF the power switch and contact your service technician.

Periodic Maintenance Message

When “Time for periodic maintenance” appears on the touch panel, the assistance from a qualified service technician is required. Contact your service technician.

13. MAINTENANCE

1. DAILY INSPECTION.....	284
2. SIMPLE TROUBLESHOOTING.....	285

1. DAILY INSPECTION

Items for Daily Check

Power switch ON/OFF status

We recommend that you turn the power switch ON at the startup everyday so as to use whenever needed. Also, be sure to turn the power switch OFF when you leave the office, except in the following cases:

- When the off-mode (or sleep mode) is set;
- When the weekly timer is in use;
- When the Fax (optional) is installed;

Weekly Maintenance

Cleaning the original glass, the original cover, the scanning area and the guide area.

To scan the original in good condition, we recommend that you clean the following items weekly.

Clean the surface with a cloth moistened with a small amount of water, alcohol or neutral detergent, then wipe a dry cloth over the surface.

- Be careful not to scratch the parts that you are cleaning.

- 1: Scanning area
- 2: Original glass
- 3: Guide
- 4: Original cover

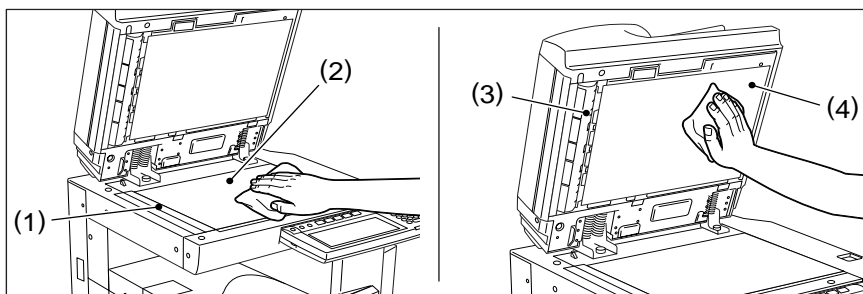

Caution

DO NOT use such solvents as thinner or alcohol when cleaning the surface of the equipment.

- This could warp the shape of the surface or leave it discoloured.
- When using a chemical cleaning pad to clean it, pay attention to any cautionary points.

2. SIMPLE TROUBLESHOOTING

Check the following items and, if the problem still occurs, call your service representative for assistance.

Warning

NEVER attempt to repair, disassemble or modify the equipment by yourself. You could cause a fire or get an electric shock.

ALWAYS contact your service representative for maintenance or repair of the internal parts of the equipment.

Equipment does not Start

Item to be checked	Countermeasure	Reference page
Is the power cord plug securely inserted in the outlet?	Insert the power cord plug until it comes to a stop.	-
Is the front cover firmly closed?	Close the cover properly.	"1.DESCRPTION OF EACH COMPONENT"  Page 20

Display does not Change when Buttons or Icons are Pressed





Item to be checked	Countermeasure	Reference page
Is the copier in the energy saving mode (Automatic Energy Saving mode)?	Press the [ENERGY SAVER] or [START] button on the control panel to clear the mode.(It takes a while for the copier to become ready.)	"Control Panel"  Page 23, "3.SWITCHING TO THE ENERGY-SAVING MODE"  Page 34
Is the power 'OFF' because the weekly timer is functioned?	Press the [START] button to return the power 'ON'.	See the [User Function Guide].
Is the department code keyed in?	Key in the correct department code.	"Controlling the Use of the Copier with Department Codes"  Page 32
Is a key copy counter (optional) used?	If you are using a key copy counter, insert it into the slot.	"Controlling the Use of the Copier Using the Optional Key Copy Counter"  Page 33
Is the "Warming up" message displayed?	Wait until the copier becomes ready.	"2.TURNING ON THE POWER SWITCH"  Page 30

Image Density is too Low











Items to be checked	Countermeasure	Reference page
Has the message "Install new toner cartridge" appeared on the screen?	Replace the toner cartridge.	"3.REPLACE TONER CARTRIDGE SYMBOL"  Page 246
Is the image density or the background adjustment set lighter than is standard?	Use the manual density buttons or the background adjustment function to adjust the image density properly.	"Manual Copy Density Mode"  Page 94, "4.BACKGROUND ADJUSTMENT"  Page 99

Image Density is too High

Items to be checked	Countermeasure	Reference page
Is the image density or the background adjustment set darker than standard?	Use the manual density buttons or the background adjustment function to adjust the image density properly.	"Manual Copy Density Mode"  Page 94, "4.BACKGROUND ADJUSTMENT"  Page 99



Images are Stained

Items to be checked	Countermeasure	Reference page
Is the original cover or the optional reversing automatic document feeder firmly closed?	Close the cover or the feeder properly to shut out any outer light.	"When Placing an Original on the Glass"  Page 47
Are the original glass, the original cover and the scanning area dirty?	Clean them up.	"Weekly Maintenance"  Page 284
Is the image density set properly?	Adjust the image density properly with the [AUTO] button or manual density buttons.	"7.COPY DENSITY ADJUSTMENT"  Page 94
Are 2-sided originals used?	As the other side of the originals can be seen, adjust the image density properly (lighter) with the background adjustment function.	"4.BACKGROUND ADJUSTMENT"  Page 99
Are originals with high transparency used?	Place a blank sheet of paper with originals of the same size or larger over the original.	"When Placing an Original on the Glass"  Page 47

Images are Blurred

Items to be checked	Countermeasure	Reference page
Does the entire originals lie properly on the surface of the glass?	Place the original on the glass or the reversing automatic document feeder and close the original cover firmly.	-
Is the paper moist?	Replace it with new paper.	"2.ADD PAPER SYMBOL"  Page 244



Images are Partially Missing

Item to be checked	Countermeasure	Reference page
Are the original size and direction, as well as the reproduction ratio suitable for the paper size?	Select copy paper of the same size as the original, or set the reproduction ratio suitable for the paper size.	"1.PAPER SELECTION"  Page 66, "3.REDUCTION AND ENLARGEMENT COPYING"  Page 72
Is the margin on the copy set properly?	Adjust the image shift value.	"1.IMAGE SHIFT"  Page 106

Functions cannot be Set

Item to be checked	Countermeasure	Reference page
Are there functions that cannot be combined set together?	See the Copying Function Combination and Image Quality Adjustment Combination Matrices and set again.	-

Desired Colour does not Appear

Item to be checked	Countermeasure	Reference page
Has the message "Install new toner cartridge" appeared on the screen?	Replace the toner cartridge.	"3.REPLACE TONER CARTRIDGE SYMBOL"  Page 246
Has the "CALL SERVICE" message appeared on the screen?	Call your service technician.	"9.CALL SERVICE SYMBOL/ PERIODIC MAINTENANCE MESSAGE"  Page 282
Is the paper moist?	Replace with new paper.	"2.ADD PAPER SYMBOL"  Page 244
Is the level of the image density and colour adjustment correct?	Reset the image density and colour adjustment to the standard settings. If the colour still deviates slightly, perform calibration.	See the [User Function Guide].

14. SPECIFICATIONS & OPTIONS

1. e-STUDIO3511/4511 SPECIFICATIONS	290
2. SPECIFICATIONS OF OPTIONS	293
3. PACKING LIST.....	301
4. COPYING FUNCTION COMBINATION MATRIX	302
5. IMAGE QUALITY ADJUSTMENT COMBINATION MATRIX	304

1. e-STUDIO3511/4511 SPECIFICATIONS

Model Name		FC-3511/FC-4511
Type		Desktop type
Original Glass		Fixed
Printing (Copying) System		Indirect electrophotographic method
Developing System		2-component magnetic brush developing
Fixing Method		Heat roller + belt fusing (Twin separated IH coil)
Photosensor Type		OPC
Original Scanning System		Flat surface scanning system (When the reversing automatic document feeder is installed: Fixed scanning system by feeding the original)
Original Scanning Sensor		Linear CCD sensor
Scanning Light Source		Xenon lamp
Resolution	Scanning	600 dpi x 600 dpi
	Writing	Black-and-white: 2,400 dpi x 600 dpi (Smoothing process), 1 bit Colour, Image smoothing: 600 dpi x 600 dpi, 8 bits
Acceptable Originals		Sheets, books and 3-dimensional objects
Acceptable Original Size		Max. A3
Acceptable Copy Paper Size	Drawer	A3, A4, A4-R, A5-R, B4, B5-R, FOLIO, 8K, 16K, 16K-R, LD, LG, LT, LT-R, ST-R, COMP, 13"LG, 8.5" SQ
	Bypass	Paper size within 100-305 mm (Length), 148-457 mm (Width)
Acceptable Copy Paper Weight	Drawer	64-105 g/m ²
	Bypass	64-209 g/m ²
Warm-up Time		Approx. 40 seconds
First Copy Time		Black-and-white: Approx. 6.8, Colour: 16.2 seconds or less
Continuous Copy Speed		See "Continuous Copy Speed".
Multiple Copying		Up to 999 copies (digital key entry)
Excluded Image Width	Black-and-white	Leading edge: 3.0±2.0 mm, Trailing edge: 3.0±2.0 mm, Both edge: 2.0±2.0 mm
	Colour	Leading edge: 5.0±2.0 mm, Trailing edge: 5.0±2.0 mm, Both edge: 2.0±2.0 mm
	Printer (Black-and-white/Colour)	Leading edge: 5.0±2.0 mm, Trailing edge: 5.0±2.0 mm, Both edge: 5.0±2.0 mm
Reproduction Ratio		Actual size: 100±0.5%
		Zoom: 25-400% (in 1% increments)
		For the reversing document feeder 25-200% (in 1% increments)

Paper Supply	Drawer	600 sheets (64 g/m ²)
	Bypass	100 sheets (64 g/m ²)
Toner Density Adjustment		Black (K): Magnetic auto-toner system Yellow (Y)/Magenta (M)/Cyan (C): Optical auto-toner system
Exposure Control		Automatic plus manual selection from 11 exposure step
Environment (for normal use)		Temperature: 10-30°C, Humidity: 20-80% (No Condensation)
Power Requirements		220-240 V ±10% (50/60 Hz) 110-127 V ±10% (50/60 Hz) (for Saudi Arabia 100V version only)
Power Consumption		At least 1.6 kW (including optional equipments) At least 1.5 kW (including optional equipments) (for Saudi Arabia 100V version only)
Dimensions (equipment only)		660 mm (W) x 700 mm (D) x 739 mm (H)
Weight		Approx. 112 kg (equipment including developer and drum)
Space Occupied (equipment only)		1,007 mm (W) x 764 mm (D)
Energy Consumption Efficiency		Max. 1,000 sheets or until the memory is full (Toshiba's own chart)

Continuous Copying Speed**Unit: sheets/min.**

Paper Type	Paper size	Feeder	e-STUDIO3511		e-STUDIO4511	
			Black-and-white	Twin colour/Colour	Black-and-white	Twin colour/Colour
Plain Paper	A4, A5-R, B5, LT, ST-R	Drawer	35	11	45	11
		Bypass	35	11	45	11
	A4-R, B5-R, LT-R	Drawer	28	5.4	32	5.4
		Bypass	28	5.4	32	5.4
	B4, FOLIO, LG, COMP	Drawer	24	5.4	26	5.4
		Bypass	24	5.4	26	5.4
	A3, LD	Drawer	21	5.4	22	5.4
		Bypass	21	5.4	22	5.4
Thick 1	A4, A5-R, B5, LT, ST-R	Drawer	30	11	30	11
		Bypass	30	11	30	11
	A4-R, B5-R, LT-R	Drawer	23	5.4	23	5.4
		Bypass	23	5.4	23	5.4
	B4, FOLIO, LG, COMP	Drawer	19	5.4	19	5.4
		Bypass	19	5.4	19	5.4
	A3, LD	Drawer	16	5.4	16	5.4
		Bypass	16	5.4	16	5.4
Thick 2	A4, A5-R, B5, LT, ST-R	Bypass	20	6.7	20	6.7
	A4-R, B5-R, LT-R	Bypass	14	3.1	14	3.1
	B4, FOLIO, LG, COMP	Bypass	11	3.0	11	3.0
	A3, LD	Bypass	10	2.9	10	2.9
Thick 3	A4, A5-R, B5, LT, ST-R	Bypass	20	2.8	20	2.8
	A4-R, B5-R, LT-R	Bypass	14	2.7	14	2.7
	B4, FOLIO, LG, COMP	Bypass	11	2.7	11	2.7
	A3, LD	Bypass	10	2.5	10	2.5
OHP Film	A4	Bypass	10	3.2	10	3.2

* The bypass copying speed is measured with the paper size specified.

* This specification varies depending on copying condition and environment.

* The paper mentioned above is Toshiba-recommended paper. Specifications and appearance are subject to change without notice in the interest of product improvement.

2. SPECIFICATIONS OF OPTIONS

Reversing Automatic Document Feeder

Model Name	MR-3015
Copy Sides	1-side, Duplex
Number of Originals (A4)	100 originals (50-80 g/m ²)
Feeding Speed	Black-and-white: 105-420 mm/s Colour: 52.5-210 mm/s
Acceptable Originals	A3 - A5-R, LD - ST-R (A5 and ST are not acceptable)
Paper Weight	50-127 g/m ² (1-sided original), 50-105 g/m ² (2-sided original)
Power Source	Power supplied from the equipment
Dimensions	557 mm (W) x 530 mm (D) x 165 mm (H)
Weight	Approx. 15 kg
Power Consumption	43.6 W max.

Large Capacity Feeder

Model Name	KD-1012
Acceptable Paper Size	A4
Paper Weight	64-105 g/m ²
Maximum Capacity	2,500 sheets (80 g/m ²) (Height: approx. 137 mm x 2)
Power Source	5V, 24 V (supplied from the equipment)
Dimensions	623 mm (W) x 657 mm (D) x 307.5 mm (H) (incl. Stabilizer)
Weight	Approx. 27 kg
Power Consumption	50 W max.

Paper Feed Pedestal (1 drawer type)

Model Name	KD-1011
Acceptable Paper Size	A3 - A5-R, LD - ST-R (A5,ST and non-standard size are not acceptable)
Paper Weight	64-105 g/m ²
Maximum Capacity	550 sheets (80 g/m ²)
Dimensions	621.5 mm (W) x 657 mm (D) x 320 mm (H)
Weight	Approx. 21.5 kg

Additional Drawer Module

Model Name	MY-1021
Acceptable Paper Size	A3 - A5-R, LD - ST-R (A5,ST and non-standard size are not acceptable)
Paper Weight	64-105 g/m ²
Maximum Capacity	550 sheets (80 g/m ²)
Dimensions	556 mm (W) x 528 mm (D) x 165 mm (H)
Weight	Approx. 3.8 kg

Saddle-Stitch Finisher (MJ-1024)

Model Name	MJ-1024			
Type	Floor type (Console type)			
Acceptable Paper Size	A3, A4, A4-R, A5-R, B4, B5, B5-R, FOLIO, LD, LG, LT, LT-R, ST-R, COMP			
Acceptable Paper Weight	60-256 g/m ²			
Number of Copies Stapled at a time (Including 2 covers (200-256 g/m ²))	Paper Size	60-80 g/m ²	81-90 g/m ²	91-105 g/m ²
	A4, A5-R, B5, LT, ST-R	50 sheets	30 sheets	30 sheets
	A3, A4-R, B4, B5-R, FOLIO, LD, LG, LT-R, COMP	30 sheets	15 sheets	15 sheets
Stapling Position	Front, Rear, Double			
Stitching Capacity (Including 2 covers (200-256 g/m ²))	Paper Size	60-80 g/m ²	81-90 g/m ²	91-105 g/m ²
	A3, A4-R, B4, LD, LT-R	15 sheets	10 sheets	10 sheets
Power Source	Supplied from the equipment			
Dimensions	649 mm (W) x 657 mm (D) x 1,086 mm (H)			
Weight	Approx. 70 kg			
Power Consumption	170 W max.			

Tray Loading Capacity (See "Available Conditions for Saddle Stitch"  Page 84 for the saddle stitch tray.)

(MJ-1024 with mixed paper not loaded)

Mode	Non-Sort		Sort/Group		Staples loaded	
	1	2	1	2	1	2
A4, A5-R, B5, LT, ST-R,	147 (1,000)	147 (1,000)	147 (1,000)	147 (1,000)	147 (1,000 sheets or 30 sets) *1	147 (1,000 sheets or 30 sets) *1
A3, A4-R, B4, B5-R, FOLIO, LD, LG, LT-R, COMP	73.5 (500)	73.5 (500)	73.5 (500)	73.5 (500)	73.5 (500 sheets or 30 sets) *1	73.5 (500 sheets or 30 sets) *1

*1. The value reached earlier by using condition

Unit: mm (with ± 7 mm allowance)

Values in parentheses is the number of 80 g/m² sheets.

Sort/Group/Staple is not available with A5-R, ST-R, B5-R.

(MJ-1024 with mixed paper loaded)

Mode	Non-Sort		Sort/Group		Staples loaded	
	1	2	1	2	1	2
LD and LT	73.5 (500)	73.5 (500)	73.5 (500)	73.5 (500)	73.5 (500 sheets or 30 sets) *1	73.5 (500 sheets or 30 sets) *1
LG and LT-R	73.5 (500)	73.5 (500)	73.5 (500)	73.5 (500)		
A4-R and FOLIO	73.5 (500)	73.5 (500)	73.5 (500)	73.5 (500)		
A3 and A4	73.5 (500)	73.5 (500)	73.5 (500)	73.5 (500)		
B4 and B5	73.5 (500)	73.5 (500)	73.5 (500)	73.5 (500)		

*1. The value reached earlier by using condition

Unit: mm (with ± 7 mm allowance)

Values in parentheses is the number of 80 g/m² sheets.

Multi-Staple Finisher (MJ-1023)

Model Name	MJ-1023			
Type	Floor type (Console type)			
Acceptable Paper Size	A3, A4, A4-R, A5-R, B4, B5, B5-R, FOLIO, LD, LG, LT, LT-R, ST-R, COMP			
Acceptable Paper Weight	60-256 g/m ²			
Number of Copies Stapled at a time (Including 2 covers (200-256 g/m ²))	Paper Size	60-80 g/m ²	81-90 g/m ²	91-105 g/m ²
	A4, A5-R, B5, LT, ST-R	50 sheets	30 sheets	30 sheets
	A3, A4-R, B4, B5-R, FOLIO, LD, LG, LT-R, COMP	30 sheets	15 sheets	15 sheets
Stapling Position	Front, Rear, Double			
Power Source	Supplied from the equipment			
Dimensions	536 mm (W) x 657 mm (D) x 1,086 mm (H)			
Weight	Approx. 39 kg			
Power Consumption	70 W max.			

Tray Loading Capacity

(MJ-1023 with mixed paper not loaded)

Mode	Non-Sort		Sort/Group		Staples loaded	
	1	2	1	2	1	2
A4, A5-R, B5, LT, ST-R	147 (1,000)	147 (1,000)	147 (1,000)	147 (1,000)	147 (1,000 sheets or 30 sets) *1	147 (1,000 sheets or 30 sets) *1
A3, A4-R, B4, B5-R, FOLIO, LD, LG, LT-R, COMP	73.5 (500)	73.5 (500)	73.5 (500)	73.5 (500)	73.5 (500 sheets or 30 sets) *1	73.5 (500 sheets or 30 sets) *1

*1.The value reached earlier by using condition

Unit: mm (with ±7 mm allowance)

Values in parentheses is the number of 80 g/m² sheets.

Sort/Group/Staple is not available with A5-R, ST-R, B5-R.

(MJ-1023 with mixed paper loaded)

Mode	Non-Sort		Sort/Group		Staples loaded	
	1	2	1	2	1	2
LD and LT	73.5 (500)	73.5 (500)	73.5 (500)	73.5 (500)	Whichever 73.5 mm, 500 sheets or 30 sets is reached first. *1	Whichever 73.5 mm, 500 sheets or 30 sets is reached first. *1
LG and LT-R	73.5 (500)	73.5 (500)	73.5 (500)	73.5 (500)		
A4-R and FOLIO	73.5 (500)	73.5 (500)	73.5 (500)	73.5 (500)		
A3 and A4	73.5 (500)	73.5 (500)	73.5 (500)	73.5 (500)		
B4 and B5	73.5 (500)	73.5 (500)	73.5 (500)	73.5 (500)		

*1. The value reached earlier by using condition

Unit: mm (with ± 7 mm allowance)

Values in parentheses is the number of 80 g/m² sheets.

Single-Staple Finisher (MJ-1022)

Model Name	MJ-1022	
Type	Hanging-type	
Acceptable Paper Size	A3, A4, A4-R, B4, B5, B5-R, A5-R, FOLIO, LD, LG, LT, LT-R, ST-R, COMP	
Acceptable Paper Weight	50-209 g/m ²	
Number of Copies Stapled at a time Acceptable weight for staple: 64-80 g/m ²	A4, A4-R, B5, LT, LT-R	30 sheets
	B4, LG	20 sheets
	A3, FOLIO, LD, COMP	15 sheets
Stapling Position	Rear	
Power Source	Supplied from the copier	
Dimensions	451 mm (W) x 539 mm (D) x 590 mm (H)	
Weight	Approx. 17 kg	
Power Consumption	40 W max.	

Tray Loading Capacity

(MJ-1022 with mixed paper not loaded)

Mode	Non-Sort		Sort/Group		Staples loaded	
	1	2	1	2	1	2
ST-R, A5-R, B5-R	30 (200)	99 (700)	-	-	-	-
LT, LT-R, A4, A4-R, B5	30 (200)	99 (700)	30 (200)	99 (700)	170 sheets or 30 sets *1	600 sheets or 50 sets *1
B4, LG	20 (140)	70 (490)	20 (140)	70 (490)	110 sheets or 30 sets *1	400 sheets or 50 sets *1
A3, FOLIO, LD, COMP	15 (100)	49 (350)	15 (100)	49 (350)	80 sheets or 30 sets *1	300 sheets or 50 sets *1

*1. The value reached earlier by using condition

Unit: mm (with ±7 mm allowance)

Values in parentheses is the number of 80 g/m² sheets.

(MJ-1022 with mixed paper loaded)

Mode	Non-Sort		Sort/Group		Staples loaded	
	1	2	1	2	1	2
Tray No.	1	2	1	2	1	2
Combination of different width paper	15 (100)	49 (350)	-	-	-	-
LD and LT	15 (100)	49 (350)	15 (100)	49 (350)	80 sheets or 15 sets *1	300 sheets or 15 sets *1
LG and LT-R	15 (100)	49 (350)	15 (100)	49 (350)	110 sheets or 15 sets *1	400 sheets or 15 sets *1
A3 and A4	15 (100)	49 (350)	15 (100)	49 (350)	80 sheets or 15 sets *1	300 sheets or 15 sets *1
B4 and B5	15 (100)	49 (350)	15 (100)	49 (350)	110 sheets or 15 sets *1	400 sheets or 15 sets *1

*1. The value reached earlier by using condition

Unit: mm (with ± 7 mm allowance)

Values in parentheses is the number of 80 g/m² sheets.

Bridge Unit

Model Name	KN-3511
Dimensions	466 mm (W) x 454 mm (D) x 175 mm (H) (incl. cover)
Weight	Approx. 3.8 kg

Hole Punch Unit

Model Name	MJ-6004
Acceptable Paper Size	A3, A4, A4-R, B4, B5, B5-R, FOLIO, LD, LG, LT, LT-R, COMP
Acceptable Paper Weight	60-256 g/m ² (OHP film and specially treated paper are not available)
Dimensions	112 mm (W) x 617 mm (D) x 378 mm (H)
Weight	Approx. 9 kg

	Number of punch holes and hole diameter	Available paper sizes
Japan and most of Europe MJ-6004E	2 holes (6.5 mm dia.)	A3, A4, A4-R, B4, B5, B5-R, FOLIO, LT, LT-R, LD, LG, COMP
France MJ-6004F	4 holes (6.5 mm dia.; 80 mm pitch)	A3, A4, LD, LT
Sweden MJ-6004S	4 holes (6.5 mm dia.; 70,21 mm pitch)	A3, A4, A4-R, B4, B5, B5-R, FOLIO, LD, LG, LT, LT-R, COMP

* The paper mentioned above is Toshiba-recommended paper. Specifications and appearance are subject to change without notice in the interest of product improvement.

3. PACKING LIST

Packing List	Photoconductive Drum
	Operator's Manual Pocket
	Unpacking Instructions
	Operator's Manual
	Setup Report
	Customer satisfaction card

4. COPYING FUNCTION COMBINATION MATRIX

Combination Matrix 1/2

Next setting	1 to 1 Simplex	1 to 2 Duplex	2 to 1 Split	2 to 2 Duplex	Book to 2	Non-sort/ Non-staple	Sort	Group	Staple sort	Magazine sort	Magazine sort & Saddle stitch	Hole punch	Saddle stitch	Rotate sort	Rotate copier (A4,B5,A5,LT)	Mixed original sizes	ADF	SADF
Already setting																		
1 to 1 Simplex	'1	'1	'1	'1	'1	YES	YES	YES	YES	'1	'1	YES	'1	YES	YES	YES	YES	YES
1 to 2 Duplex	'1	'1	'1	'1	'1	YES	YES	YES	YES	YES	YES	YES	'1	YES	YES	(YES)	YES	YES
2 to 1 Split	'1	'1	'1	'1	'1	YES	YES	YES	YES	NO	NO	YES	'1	YES	YES	YES	YES	YES
2 to 2 Duplex	'1	'1	'1	'1	'1	YES	YES	YES	YES	YES	YES	YES	'1	YES	YES	YES	YES	YES
Book to 2	'1	'1	'1	'1	'1	YES	YES	YES	(YES)	NO	NO	YES	'1	NO	NO	NO	YES	--
Non-sort/Non-staple	YES	YES	YES	YES	YES	YES	'1	'1	'1	'1	'1	YES	'1	'1	'1	YES	YES	YES
Sort	YES	YES	YES	YES	YES	'1	'1	'1	'1	'1	'1	YES	'1	'1	'1	YES	YES	YES
Group	YES	YES	YES	YES	YES	'1	'1	'1	'1	'1	'1	YES	'1	'1	'1	YES	YES	YES
Staple sort	YES	YES	YES	YES	YES	'1	'1	'1	'1	'1	'1	YES	'1	'1	'1	(YES)	YES	YES
Magazine sort	NO	YES	NO	YES	NO	'1	'1	'1	'1	'1	'1	NO	'1	'1	'1	NO	YES	YES
Magazine sort & Saddle stitch	NO	YES	NO	YES	NO	NO	'1	'1	'1	'1	'1	NO	'1	'1	'1	NO	YES	YES
Hole punch	YES	YES	YES	YES	YES	YES	YES	YES	YES	NO	NO	NO	NO	NO	NO	(YES)	YES	YES
Saddle stitch	NO	NO	NO	YES	NO	'1	'1	'1	'1	'1	'1	NO	NO	NO	'1	NO	YES	YES
Rotate sort	YES	YES	YES	YES	NO	'1	'1	'1	'1	'1	'1	NO	NO	'1	'1	NO	YES	YES
Rotate copier (A4,B5,A5,LT)	--	--	--	--	--	--	--	--	--	YES	YES	YES	YES	YES	YES	YES	YES	YES
Mixed original sizes	YES	YES	YES	YES	YES	YES	YES	YES	(YES)	NO	NO	(YES)	NO	NO	NO	YES	YES	YES
ADF	YES	YES	YES	YES	--	YES	YES	YES	YES	YES	YES	YES	YES	YES	YES	YES	YES	YES
SADF	YES	YES	YES	YES	--	YES	YES	YES	YES	YES	YES	YES	YES	YES	YES	YES	YES	'1
Image direction	YES	YES	YES	YES	YES	YES	YES	YES	YES	YES	YES	YES	YES	YES	YES	YES	YES	YES
Book - Tablet	'1	'1	'1	'1	NO	YES	YES	YES	YES	YES	YES	YES	YES	YES	YES	YES	YES	YES
Edge erase	YES	YES	YES	YES	YES	YES	YES	YES	YES	NO	NO	YES	YES	YES	YES	YES	YES	YES
Image shift	YES	YES	YES	YES	YES	YES	YES	YES	YES	NO	NO	YES	YES	YES	YES	NO	YES	YES
ZIN1/4IN1	YES	YES	YES	YES	NO	YES	YES	YES	YES	NO	NO	YES	YES	YES	YES	NO	YES	YES
Book centre erase	YES	YES	NO	NO	NO	YES	YES	YES	YES	NO	NO	NO	NO	YES	YES	NO	YES	--
XY zoom	YES	YES	YES	YES	NO	YES	YES	YES	YES	NO	NO	YES	NO	NO	NO	NO	YES	YES
Dual page	YES	YES	NO	NO	NO	YES	YES	YES	YES	NO	NO	YES	NO	NO	NO	NO	YES	--
Mirror	YES	YES	YES	YES	NO	YES	YES	YES	YES	NO	NO	YES	NO	YES	YES	NO	YES	YES
TrimMask	YES	YES	YES	YES	YES	YES	YES	YES	YES	NO	NO	YES	NO	YES	YES	NO	YES	YES
Top blank	YES	YES	YES	YES	NO	NO	YES	YES	YES	YES	YES	YES	YES	NO	NO	YES?2	YES	YES
Cover sheet	YES	YES	YES	YES	NO	NO	YES	NO	YES	YES	YES	YES	YES	NO	NO	YES?2	YES	YES
Both blank	YES	YES	YES	YES	NO	NO	YES	NO	YES	YES	YES	YES	YES	NO	NO	YES?2	YES	YES
Top copied back blank	YES	YES	YES	YES	NO	NO	YES	NO	YES	NO	NO	YES	NO	NO	NO	YES?2	YES	YES
Sheet insertion	YES	YES	YES	YES	NO	NO	YES	NO	YES	NO	NO	YES	NO	NO	NO	YES?2	YES	YES
Date stamp	YES	YES	YES	YES	YES	YES	YES	YES	YES	NO	NO	YES	NO	NO	NO	YES?2	YES	YES
Page number	YES	YES	YES	YES	YES	YES	YES	YES	YES	YES	YES	YES	NO	YES	YES	NO	YES	YES

(YES): The result is not guaranteed although the function are operable.
 *1: The function set last takes precedence.
 *2: Only AMS (Automatic Magnification Selection).

YES: The functions can be combined.
 NO: The function set first takes precedence.

Combination Matrix 2/2

Next setting	Image direction	Book - Tablet	Edge erase	Image shift	2IN1/4IN1	Book centre erase	XY zoom	Dual page	Mirror	Trim/ Mask	Cover sheet			Sheet insertion	Date stamp	Page number
											Top blank	Top copied	Both blank			
Already setting	YES	'1	YES	YES	'1	YES	YES	'1	YES	YES	YES	YES	YES	YES	YES	
1 to 1 Simplex	YES	'1	YES	YES	'1	YES	YES	'1	YES	YES	YES	YES	YES	YES	YES	
1 to 2 Duplex	YES	'1	YES	YES	'1	NO	YES	NO	YES	YES	YES	YES	YES	YES	YES	
2 to 1 Split	YES	YES	YES	YES	'1	NO	YES	NO	YES	YES	YES	YES	YES	YES	YES	
2 to 2 Duplex	YES	YES	YES	YES	'1	NO	YES	NO	YES	YES	YES	YES	YES	YES	YES	
Book to 2	YES	NO	YES	YES	NO	NO	NO	NO	NO	NO	NO	NO	NO	YES	YES	
Non-sort/Non-staple	YES	YES	YES	YES	YES	YES	YES	YES	YES	'1	'1	'1	'1	YES	YES	
Sort	YES	YES	YES	YES	YES	YES	YES	YES	YES	YES	YES	YES	YES	YES	YES	
Group	YES	YES	YES	YES	YES	YES	YES	YES	YES	YES	NO	NO	NO	YES	YES	
Staple sort	YES	YES	YES	YES	YES	YES	YES	YES	YES	YES	YES	YES	YES	YES	YES	
Magazine sort	YES	NO	YES	NO	NO	NO	NO	NO	NO	NO	YES	NO	NO	YES	YES	
Magazine sort & Saddle stitch	YES	NO	YES	NO	NO	NO	NO	NO	NO	NO	YES	NO	NO	YES	YES	
Hide punch	YES	NO	YES	YES	YES	NO	YES	YES	YES	YES	YES	YES	YES	YES	YES	
Hole punch	YES	NO	YES	YES	NO	NO	YES	YES	YES	YES	YES	YES	YES	YES	YES	
Saddle stitch	YES	NO	YES	NO	NO	NO	NO	NO	NO	NO	YES	NO	NO	NO	NO	
Rotate sort	YES	YES	YES	YES	YES	YES	NO	NO	YES	YES	NO	NO	NO	YES	YES	
Rotate copier (LT A4,B5,A5)	YES	YES	YES	'1	YES	'1	'1	YES	YES	YES	YES	YES	YES	YES	YES	
Mixed original sizes	YES	YES	NO	NO	NO	NO	NO	NO	NO	NO	NO	NO	NO	NO	NO	
ADF	YES	YES	YES	YES	YES	--	YES	--	YES	YES	YES	YES	YES	YES	YES	
SADF	YES	YES	YES	YES	YES	--	YES	--	YES	YES	YES	YES	YES	YES	YES	
Image direction	YES	YES	YES	YES	YES	YES	YES	YES	YES	YES	YES	YES	YES	YES	YES	
Book - Tablet	YES	YES	YES	NO	NO	NO	YES	NO	YES	YES	YES	YES	YES	YES	NO	
Edge erase	YES	YES	YES	YES	YES	NO	YES	YES	NO	YES	YES	YES	YES	YES	YES	
Image shift	YES	NO	YES	YES	YES	YES	YES	YES	YES	YES	YES	YES	YES	YES	YES	
2IN1/4IN1	YES	NO	YES	YES	YES	NO	YES	YES	YES	YES	YES	YES	YES	YES	YES	
Book centre erase	YES	NO	NO	YES	NO	NO	YES	NO	YES	NO	NO	NO	NO	YES	YES	
XY zoom	YES	YES	YES	YES	NO	YES	NO	NO	NO	NO	YES	YES	YES	YES	YES	
Dual page	YES	NO	YES	YES	NO	NO	NO	NO	NO	NO	NO	NO	NO	YES	YES	
Mirror	YES	YES	NO	YES	NO	YES	NO	NO	NO	--	YES	YES	YES	YES	YES	
Trim/Mask	YES	YES	NO	YES	NO	NO	NO	NO	--	YES	YES	YES	YES	YES	YES	
Top blank	YES	YES	YES	YES	NO	NO	YES	NO	YES	YES	--	--	--	YES	YES	
Cover	YES	YES	YES	YES	NO	NO	YES	NO	YES	YES	--	--	--	YES	YES	
Both blank	YES	YES	YES	YES	NO	NO	YES	NO	YES	YES	--	--	--	YES	YES	
Top copied back blank	YES	YES	YES	YES	NO	NO	YES	NO	YES	YES	--	--	--	YES	YES	
Sheet insertion	YES	YES	YES	YES	NO	NO	YES	NO	YES	YES	YES	YES	YES	YES	YES	
Date stamp	YES	NO	YES	YES	YES	YES	YES	YES	YES	YES	YES	YES	YES	YES	YES	
Page number	YES	NO	YES	YES	YES	YES	YES	YES	YES	YES	YES	YES	YES	YES	YES	

YES: The functions can be combined.
 NO: The function set first takes precedence.
 (YES): The result is not guaranteed although the function are operable.
 (YES): The function set last takes precedence.
 *1: Only AMS (Automatic Magnification Selection).

5. IMAGE QUALITY ADJUSTMENT COMBINATION MATRIX

Next setting	Density		Colour mode				Colour balance	RGB adjustment	Sharpness	Background	One-touch adjustment			
	Manual	Auto	ACS	Full colour	Black	Twin colour					Vivid	Clear	Warm	Cool
Already setting														
Density Manual/Auto	YES	YES	YES	YES	YES	YES	YES	YES	YES ¹	YES ¹	YES	YES	YES	YES
Colour mode	YES	YES	*1	*1	*1	*1	YES	YES	YES	YES	YES	YES	YES	YES
ACS	YES	YES	YES	*1	*1	*1	YES	YES	YES	YES	YES	YES	YES	YES
Full colour	YES	YES	*1	*1	*1	*1	YES	YES	YES	YES	YES	YES	YES	YES
Black	YES	YES	*1	*1	*1	*1	NO	NO	NO	NO	NO	NO	NO	NO
Twin colour	YES	YES	*1	*1	*1	*1	NO	NO	NO	NO	NO	NO	NO	NO
Colour balance	YES	YES	*1	YES	*1	NO	NO	YES	YES	YES	YES	YES	YES	YES
RGB adjustment	YES	YES	*1	YES	*1	NO	NO	YES	YES	YES	YES	YES	YES	YES
Sharpness	YES	YES	YES	YES	YES	YES	YES	YES	YES	YES	YES	YES	YES	YES
Background	YES ²	YES	*1	YES	*1	NO	YES	YES	YES	YES	YES	YES	YES	YES
Vivid	YES	YES	*1	YES	*1	NO	NO	NO	NO	NO	NO	NO	NO	NO
Clear	YES	YES	*1	YES	*1	NO	NO	NO	NO	NO	NO	NO	NO	NO
Warm	YES	YES	*1	YES	*1	NO	NO	NO	NO	NO	NO	NO	NO	NO
Cool	YES	YES	*1	YES	*1	NO	NO	NO	NO	NO	NO	NO	NO	NO

YES: The functions can be combined.

NO: The function set first takes precedence.

*1: The function set last takes precedence.

*2: Not available in Auto Exposure.

INDEX

Numerics

1-Sided Originals -> 1-Sided Copies (default setting)	88
1-Sided Originals -> 2-Sided Copies	88
2 IN 1/4 IN 1	113
2-Sided Originals -> 1-Sided Copies	90
2-Sided Originals -> 2-Sided Copies	89

A

Acceptable copy paper types and sizes	36
Acceptable Original Types and Sizes	45
Acceptable Original Types and Sizes/ Maximum Number of Sheets that can be Stored	45
Acceptable paper size	91
ACCESS button	24
ACCESS CODE	33
ADD PAPER SYMBOL	244
Adding a blank cover	122
Adding a copied cover	122
Adding Paper to the Drawers	244
Adding Paper to the Large Capacity Feeder	245
ADDING STAPLES (OPTIONAL)	268
Address Book Entry	168
ADDRESS REGISTRATION FROM LOG LISTS	199
Admin Password	228, 229, 233, 237
Advanced Function	177
Advice	8
AUTO COLOUR	71
Auto Exposure	52
Auto Job Start	30, 55, 56
AUTO JOB START (JOB PRESET)	55
Automatic Copy Density Modes	94
Automatic duplexer	20
Automatic Function Clear	24, 29
Automatic Magnification Selection (AMS)	72
Automatic paper selection	52
Automatic Paper Selection (APS)	66
Available Conditions for Saddle Stitch	84
Available paper size	86
Available paper sizes for the hole punch	85

B

BACKGROUND ADJUSTMENT	99
Basic screen	33
basic screen	24, 27
Black mode	52
Black toner	20
BLACK-AND-WHITE/COLOUR COPY MODE SELECTION	71
BLINKING GRAPHIC SYMBOLS	242
BOOK CENTRE ERASE	110
Bookbinding margin	107, 111

Booklet mode	82
Book-type Originals	48
Book-type Originals -> 2-Sided Copies	91
BYPASS COPYING	59
Bypass Copying on Non-Standard-Size Paper	62
Bypass Copying on Standard Size of Paper	59
bypass feeding	12, 59, 83, 116
BYPASS MISFEED	242
Bypass tray	20

C

CALL SERVICE SYMBOL	243
Call Service Symbol	282
CALL SERVICE SYMBOL/PERIODIC MAINTENANCE MESSAGE	282
Caution	8
CHANGING INPUT DATA	216, 233
Changing the Data of Template	233
Changing the Data of User Group	235
Changing the Paper Size of the Drawer	38
Changing the Paper Size of the Drawer/Setting the Drawer for Special Uses	38
CHECK ORIGINALS	242
CLEAR button	24, 98
CLEAR PAPER SYMBOL	254
Clearing the Drawer for Special Uses	44
Clearing the Functions Selected	29
Colour Adjustment	288
COLOUR BALANCE	96, 97
COLOUR EDITING AND ADJUSTMENT	95
Colour mode	93
Colour of toner (Cyan/Magenta/Yellow)	20
Coloured paper	41, 122, 125
Confirming and Canceling Auto Job Start	56
Confirming the Destinations	176
CONFIRMING THE STATUS OF FAX/INTERNET FAX JOB	194
CONFIRMING THE STATUS OF SCAN	195
Continuous Copying Speed	292
Continuous Feed Mode	50, 133
Continuous original feed mode	52
CONTINUOUS/SINGLE ORIGINAL FEEDING	133
Control Panel	20, 23
Controlling the Use of the Copier Using the Optional Key Copy Counter	33
Controlling the Use of the Copier with Department Codes	32
COPY button	23
COPY DENSITY ADJUSTMENT	94
Copy paper	36, 41
Copying function combination	288
COPYING FUNCTION COMBINATION MATRIX	302
Copying Procedure	52

INDEX (Cont.)

Cost Advantage	7
COVER COPYING	122
Cover sheet copying	57
Creating a Bookbinding Margin	107
Creating a Right or Left Margin	106
Currently selected drawer size	27

D

DAILY INSPECTION	284
Date and time	27
default setting	23, 24
Deleting a Job	185, 189
Deleting a Job from the List	193
Deleting a Private Print	191
Deleting a User Group	239
DELETING BOX	218
DELETING TEMPLATE	237
department code	32
Dependability	7
DESCRIPTION OF EACH COMPONENT	20
DESCRIPTION OF THE BLINKING GRAPHIC SYMBOLS	242
Desired colour does not appear	288
DIGITAL KEYS	24
Direct Entry	167
DIRECTION OF COPY IMAGES IN "1 TO 2" AND "2 TO 1"	130
DIRECTION OF DUPLEX COPY IMAGES IN "2 TO 2"	132
DISCLAIMER NOTICE	17
DISPOSING OF THE PUNCHED PAPER BITS (OPTIONAL)	281
drawer feeding	83, 116
Drawer for cover sheet	41, 123, 124
Drawer for sheet insertion	41
Drawer for special sheets.	41
DRAWER MISFEED	242
Drawers	20
DUAL-PAGE	111
Dual-page	59
Dual-Page mode	107
DUPLEX COPYING	87
DUPLEXER MISFEED	242
During Maintenance or Inspection	15

E

EDGE ERASE	109
Edge erase	59
Edge Erase Copying	109
e-FILING	211
e-FILING button	23
e-FILING FUNCTIONS	212
ENERGY SAVER button	24, 34, 285
Enlargement copying	72, 113
Entering Letters	141

Environmental Harmony	7
Equipment does not Start	285
ERROR lamp	24
e-STUDIO 3511/4511 SPECIFICATIONS	290
Execute Test Printing	220
Exit cover	267
EXTENSION button	23

F

FAX button	23
Features of the e-STUDIO3511/4511	9
Feeder	36, 292
Finisher (optional MJ-1022)	264
Finisher (optional MJ-1024/1023)	263
FINISHER/HOLE PUNCH UNIT MISFEED	243
Finishing Modes and Finishers (Optional)	76
For Making 1-sided, 2-sided and Book-type Copying	87
Front cover	20, 77
FULL COLOUR mode	71
FUNCTION CLEAR button	24
Function setting area	27
Functions cannot be set	288
FUSER MISFEED	242
Fuser Unit	259

G

General	7
GENERAL COPYING PROCEDURES	52
GENERAL PRECAUTIONS	10
Group copying	78
Group Entry	169

H

Handling and Storing Paper	37
HELP button	23
High Productivity	7
Hole Punch Mode (Optional)	85
Hole punch unit (MJ-6004)	77
HOW TO MAKE COPIES	35

I

Image Density is too High	286
Image Density is too Low	286
IMAGE EDITING	118
IMAGE SHIFT	106
Image shift	59, 228, 230
Images are Blurred	287
Images are partially missing	288
Images are Stained	287
In the Continuous Feed Mode	50
Initial (default) Settings	52
Inner tray	20
INSERT 1	43, 44
INSERT 2	43, 44

INSERT SOURCE 2	126
Inside the Single-feed Mode	51
INTERNET FAX	161, 162
Internet Fax Transmission Overview	162
INTERRUPT button	24, 57
INTERRUPT COPYING	57
Items for Daily Check	284

J

JAM RELEASING UNIT MISFEED	242
JOB STATUS	183, 184
JOB STATUS button	24, 54, 56

K

Key copy counter	33
key copy counters	32

L

Large Capacity Feeder	257
LOG LIST	196

M

Machine Balance	7
MAGAZINE SORT	116
Magazine Sort	82, 116
MAGAZINE SORT & SADDLE STITCH button	82, 83
Magazine Sort & Saddle Stitch Mode (Booklet Mode)	82
Main Components	20
MAINTENANCE	283
Manual Copy Density Mode	94
Manual Paper Selection	68
Masking	118
Maximum capacity for saddle stitch	84
Maximum number of sheets that can be set	39, 244, 245
Maximum Number of Sheets that can be Stapled	81
Maximum Number of Sheets that can be Stored	46
Maximum sheet capacity	36
Message Display	27
Mirror Image	120
MJ-1022 with mixed paper loaded	299
MJ-1022 with mixed paper not loaded	298
MJ-1023 with mixed paper loaded	297
MJ-1023 with mixed paper not loaded	296
MJ-1024 with mixed paper loaded	295
MJ-1024 with mixed paper not loaded	295
MONITOR/PAUSE button	24
Moving a Print Job	187
Multi-address Transmission	175
Multi-Staple Finisher (MJ-1023)	296

N

NOTICE TO USERS	5
Number of punch holes and hole diameter	86, 300

O

ONE-TOUCH ADJUSTMENT	98
Operator's Manual Pocket	20, 301
Optimum image Quality	7
Optional	20
Optional Equipment	21
OPTIONAL FEEDER MISFEED	242
ORIGINAL MODE	93
Original scale	20

P

PACKING LIST	301
PAGE NUMBERING	128
Paper Misfeed in the Automatic Duplexer	258
Paper Misfeed in the Drawer Feeding Area	256
Paper Misfeed in the Finisher (optional MJ-1024/1023)	263
Paper Misfeed in the Fuser Unit	259
Paper Misfeed in the Hole Punch Unit (optional)	262
Paper Misfeed in the Jam Releasing Unit	259
Paper Misfeed in the Large Capacity Feeder (optional)	257
Paper Misfeed in the Relay Unit (optional)	261
Paper Misfeed in the Reversing Automatic Document Feeder (optional)	254
Paper Misfeed in the Saddle-Stitch Finisher (optional MJ-1024)	265
Paper Misfeed in the Single-staple Finisher (optional MJ-1022)	264
Paper Misfeed on the Bypass Feed Unit	258
PAPER SELECTION	66
Paper Size	36
paper with a watermark	41
Pausing and Resuming a Print Job	186
Performing the Proof Print	188
PERIODIC MAINTENANCE MESSAGE	282
Periodic Maintenance Message	282
Photoconductive Drum	301
Power switch	20
Precaution for Internet Transmission	162
Precautions for Using the Reversing Automatic Document Feeder	49
PREFACE	8
PRINT DATA/MEMORY RX/FAX communication	24
PRINT JOB LIST	185
Print the whole document	219
PRINTING SEND/RECEIVE LOG LIST OF FAX	201

INDEX (Cont.)

PRINTING STORED DOCUMENT	219
Printing the Stored Document with	
Added/Changed Settings	221
Priority Transmission	178
Private Print	190
PRIVATE PRINT JOB	190
PROOF PRINT JOB	188

R

RECALLING TEMPLATE	225
Receiving from POP3 Server	180
Receiving from SMTP Server	181
RECEIVING INTERNET FAX	180
Receiving Modes	180
Recommendation for original toner	247
REDUCTION AND ENLARGEMENT	
COPYING	72
REGISTERING TEMPLATE	228
Registering the template in the Private	
Group	230
Registering the template in the Public	
Template Group	228
RELAY UNIT MISFEED	242
Remaining paper level	27
REMOVING JAMMED STAPLES	
(OPTIONAL)	274
REPLACE TONER BAG SYMBOL	243, 253
REPLACE TONER CARTRIDGE	243
REPLACE TONER CARTRIDGE SYMBOL	246
Replacing the Black (K) Toner Cartridge	248
Replacing the Yellow (Y), Magenta (M),	
Cyan (C) Toner Cartridge	250
Reproduction ratio	27, 52
RGB ADJUSTMENT	97
Rotate Sort Mode	79

S

Saddle Stitch Finisher (MJ-1024)	294
SADDLE STITCHING UNIT MISFEED	243
Saddle-Stitch Finisher (MJ-1024)	270, 276
Saddle-Stitch Finisher (MJ-1024)/Multi-Staple	
Finisher (MJ-1023)	268, 274
SAVE AS FILE	139
SCAN button	23, 225
SCAN SETTING IN THE TOUCH PANEL	144
SCAN TO e-FILING	147
SCAN TO E-MAIL	155
SCAN TO FILE	151
Scanning Procedure	145
SCANNING THE IMAGES	143
Searching by Address	173
Searching by ID Number	171
SELECTING FINISHING MODES	76
Sending 2-sided Originals	177
SENDING INTERNET FAX	164

Service and Support Benefits	7
SETTING COPY PAPER	36
Setting Magazine Sort & Saddle Stitch Mode	82
SETTING OF BASIC COPY MODES	65
SETTING ORIGINALS	45
Setting Staple Sort Mode	80
Setting the Drawer for Special Uses	38, 41
Setting the Transmission Conditions	164
SETTING UP BOX	214
Setup Report	301
SHARPNESS ADJUSTMENT	100
SHEET INSERTION MODE	125
Sheet Originals	47
SIMPLE TROUBLESHOOTING	285
Single-feed Mode	51, 134
Single-Staple Finisher (MJ-1022)	272, 279, 298
Sort copying	78
Sort/Group Copying	78
SPECIFICATIONS & OPTIONS	289
SPECIFICATIONS OF OPTIONS	293
Specifying Both Original Size and Copy Size	73
Specifying the Recipients	167
Stable Image Quality	7
Staple Sort	80
Staple Sorting	80
START button	24
STATUS	202
Sticker labels	9, 36, 59
STOP button	24
STOPPING THE COPY OPERATION	58
STORE TO E-FILING	136
Storing a Non-Standard Size in the MEMORY	63
STORING ORIGINALS	135
Supplies/Parts	7
SWITCHING TO THE ENERGY-SAVING	
MODE	34

T

TEMPLATE	223, 224
TEMPLATE button	23, 226, 228
TEXT/PHOTO mode	52
The recommended paper	37
Thick 1	36, 37, 43, 292
Thick 2	36, 37
Thick 3	36, 37
TIME & DATE STAMP	127
Tip	8
To Restore the Invalid Code (print error) to the	
Normal Print	192
Toner	7
TOP COPIED button	123, 124
TOSHIBA QUALITY IS SECOND TO NONE	6
Toshiba-recommended paper/Handling and	
Storing Paper	37
Total copy quantity	27

TOUCH PANEL	20, 24, 27
Touch panel contrast adjustment volume	20
Touch-buttons	27
Tray load capacity	81, 84
Trays	77
Trimming	118
Trimming/Masking	118
TURNING ON THE POWER SWITCH	30
Twin (2-colour) Copy with Selected Colours ...	101
TWIN (2-COLOUR) COPYING	101
Twin (2-Colour) Copying with Red and Black ..	103
Types of originals	45

U

Unpacking Instructions	301
Upper cover	77
Used toner bag	20
User Friendly	7
USER FUNCTIONS button	23
USING THE EDITING FUNCTIONS	105
Using the Reduction/Enlargement Zoom Buttons or One-touch Zoom Buttons	74

W

Warning	8
Weekly Maintenance	284
When Coming Across the Situations below	54
When handling supplies	16
When Installing or Moving	10
When Placing an Original on the Glass	47
When recalling Template in the Public Group .	225
When recalling Template in the Uesr Group ...	226
WHEN THE GRAPHIC SYMBOLS BLINK ON THE TOUCH PANEL	241
WHEN USING THE DEPARTMENT CODES .	192
When using the Multifunctional digital colour system	13
When Using the Reversing Automatic Document Feeder	49

X

X-Y ZOOM	121
----------------	-----

Version 1.0

TOSHIBA

TOSHIBA TEC
Germany Imaging Systems GmbH
Carl-Schurz-Straße 7 · 41460 Neuss
Phone: +49 - (0) 2131/ 1245-0
Fax: +49 - (0) 2131/ 1245-402
www.toshiba-europe.com/tec